

Quality analysis of electrical energy and power grids

DIRIS Q800



1. INTRODUCTION	6
2. GRAPHIC SYMBOLS	6
3. PRELIMINARY VERIFICATION	6
4. GENERAL DESCRIPTION	7
4.1. Front panel.....	7
4.2. Rear panel	8
5. INSTALLATION	9
5.1. Environmental requirements	9
5.2. Mounting	9
6. ELECTRICAL CONNECTIONS	10
6.1. Safety measures	12
6.2. Protective earth.....	12
6.3. Measurement inputs.....	13
6.3.1. Wiring diagrams.....	14
6.4. Power supply.....	16
6.4.1. Fuse replacement	16
6.4.2. Backup battery and switch.....	17
6.4.3. Battery replacement	18
6.5. GPS port	19
6.6. Communication	20
6.6.1. ETHERNET port.....	20
6.6.2. RS485 port.....	20
6.6.3. WI FI port	21
6.7. Inputs & outputs	22
6.8. Instrument switching on.....	22
7. INSTRUMENT FUNCTIONS	23
7.1. Introduction	23
7.2. Touch screen display & USB port.....	23
7.2.1. Virtual keyboard	23
7.2.2. Data transfer/upload	23
7.2.3. USB flash drive plugin/eject	23
7.3. Measurement monitoring	24
7.4. Wiring modes (voltages/currents)	31
7.5. Internal clock synchronisation	31
7.6. Mains signalling	31
7.7. Demand values	31
7.8. Recording functions	32
7.9. Event recording	32
7.9.1. Fast 3phase voltage events	33
7.9.2. Rapid voltage changes	35
7.9.3. Frequency fast events.....	36
7.9.4. Fast U4 voltage events	37
7.9.5. Fast current events	38
7.9.6. Slow voltage events	39
7.9.7. Slow frequency events	41
7.9.8. Slow flicker events.....	42
7.9.9. Slow voltage THD events	43
7.9.10. Slow unbalance events.....	44
7.9.11. Mains Signalling events.....	45
7.9.12. Generated event file name	46

7.10. Digital input LOG.....	.46
7.11. Logging47
7.11.1. Min/Avg/Max LOG.....	.47
7.11.2. Demand LOG.....	.47
7.11.3. Frequency LOG48
7.11.4. Energy counter LOG48
7.11.5. Functional LOG49
7.12. Demand Max.....	.50
7.13. Recording transfer50
7.13.1. How to upload the recorded data on a remote server.....	.50
7.13.2. Data upload triggered by frequency event.....	.51
7.13.3. Daily data upload.....	.51
7.13.4. Data upload triggered by full memory.....	.52
7.14. Automatic email for alarms/events.....	.52
7.15. WIFI feature.....	.53
8. WEB SERVER54
8.1. Web server structure54
8.1.1. Control features for graphic view.....	.55
8.2. Real Time.....	.56
8.3. Harmonics58
8.4. Graphics.....	.60
8.5. Recordings.....	.63
8.5.1. PQ Events.....	.63
8.5.2. U4 Voltage Events70
8.5.3. Current Events.....	.71
8.5.4. Min/Avg/Max72
8.5.5. Data LOG73
8.5.6. Demand MAX.....	.77
8.6. Status.....	.78
8.7. Settings79
8.7.1. General80
8.7.2. Thresholds83
8.7.3. Min/Avg/Max87
8.7.4. Demand LOG.....	.93
8.7.5. Data LOG96
8.7.6. Communication97
8.7.7. Digital inputs.....	.103
8.7.8. Analog outputs.....	.103
8.7.9. Digital outputs104
8.8. Administration106
8.8.1. Instrument firmware upgrade.....	.107
8.8.2. Instrument configuration XML file uploading107
8.8.3. Administrator password108
8.8.4. Display interface upgrade.....	.108
9. DIRIS Q800 CLASS A MONITORING TOOL.....	.109
9.1. How to start DIRIS Q800 Monitoring Tool.....	.109

10. MAINTENANCE	110
10.1. INSTRUMENT END-OF-LIFE	110
11. TECHNICAL SPECIFICATIONS	111
12. SPECIFICATIONS FOR IEC/EN 61000-4-30:2015 ED.3 COMPLIANCE	113
12.1. DIRIS Q800 - Analyser software for EN 50160 analysis	114
13. TROUBLE-SHOOTING	116
ANNEXE I. MODBUS - COMMUNICATION PROTOCOL	117
1. DESCRIPTION	117
1.1. CRC generation	118
2. COMMAND STRUCTURE	121
2.1. MODBUS RTU	121
2.2. MODBUS TCP	122
2.3. Floating point as per IEEE Standard	123
3. EXCEPTION CODES	124
3.1. MODBUS RTU	124
3.2. MODBUS TCP	125
4. REGISTER TABLES	126
4.1. Registers (Function code \$03 / \$04 / \$06 / \$10)	126
5. READING COMMAND EXAMPLES	248
5.1. MODBUS RTU	248
5.2. MODBUS TCP	251

1. INTRODUCTION

This manual provides information on the installation, configuration and use of the instrument functions. The manual is not intended for general use, but for qualified technicians. This term indicates a professional and skilled technician, authorised to act in accordance with the safety standards relating to the dangers posed by electric current. This person must also have basic first aid training and be in possession of suitable Personal Protective Equipment.



WARNING! It is strictly forbidden for anyone who does not fulfill the above-mentioned requirements to install or use the instrument.

The instrument complies with the European Union directives in force, as well as with the technical standards implementing these requirements, as certified by the CE mark on the device and on this Manual. Using the meter for purposes other than intended ones, understood by the manual content, is strictly forbidden. The information herein contained shall not be shared with third parties. Any duplication of this manual, either partial or total, not authorised in writing by the Manufacturer and obtained by photocopying, duplicating or using any other electronic means, violates the terms of copyright and is punishable by law. Any brands quoted in the publication belong to the legitimate registered owners.

2. GRAPHIC SYMBOLS

On the manual some instructions are highlighted by graphic symbols to draw the reader's attention on the operational dangers. The following graphic symbols are used:



DANGER! This warning indicates the possible presence of dangerous voltage on the marked terminals (even if for short periods).



WARNING! This warning indicates the possible occurrence of an event which may cause a serious accident or considerable damage to the device if suitable precautionary countermeasures are not taken.



Note: this symbol indicates important information which must be read carefully.

3. PRELIMINARY VERIFICATION



Note :at the opening of the box, check that the instrument has not been damaged during transport. If the instrument appears to be damaged, contact the technical after-sales service.

The box contains:

- instrument with installed terminal blocks
- four fastening accessories
- ferrite
- quick guide
- USB flash drive with user manual and software tools
- WI FI antenna
- GPS patch antenna (10 m cable) and bracket







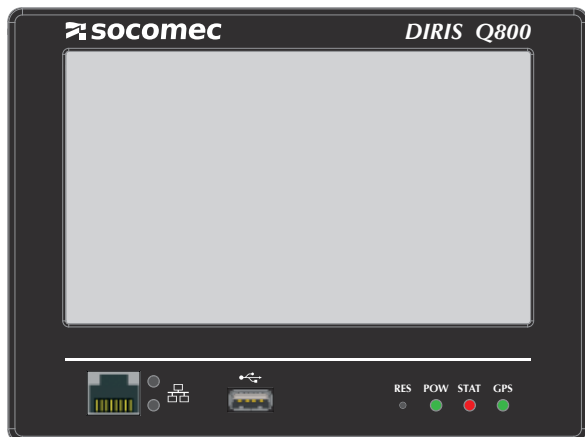

4. GENERAL DESCRIPTION

The instrument is a network analyser able to monitor the power quality in compliance with EN 50160 and IEC/EN 61000-4-30:2015 Ed.3 standards. It can detect and store the voltage and frequency variations, voltage sags and swells, short or long interruptions, flicker, harmonics, powers and other power quality parameters.

The instrument can be managed by the touch screen display or at distance by using a web interface. This useful feature allows to manage the instrument in a quick and easy way by any PC or tablet, using a web browser (e.g. Internet Explorer, Mozilla Firefox, Safari, Google Chrome).



4.1. Front panel

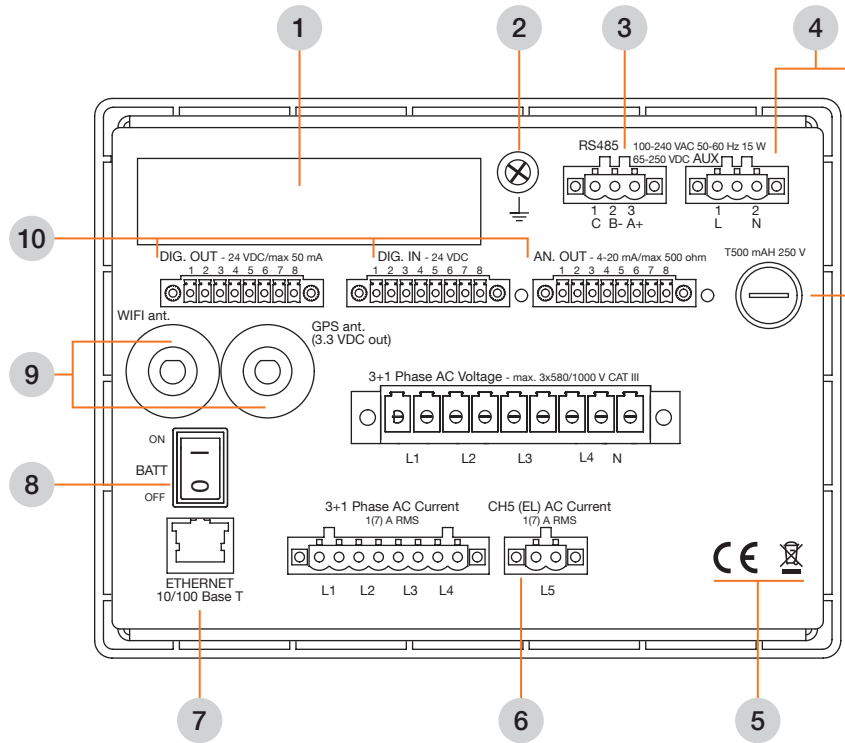

PART	FUNCTION
	Front Auto MDIX ETHERNET port for a PC quick connection.
	Front Ethernet port communication speed. <ul style="list-style-type: none"> • ON: Ethernet connection in progress at 100 Mbit/s speed. • OFF: Ethernet connection in progress at 10 Mbit/s speed.
	Front Ethernet port connection status. <ul style="list-style-type: none"> • ON: link ok. • Blinking: link activity.
	Host USB port for: <ul style="list-style-type: none"> • Transferring the instrument recorded data • Uploading the firmware file or the configuration file on the instrument
	Double function button: <ul style="list-style-type: none"> • SET DEFAULT function: restores the following settings to the default values. <ul style="list-style-type: none"> - Instrument IP address > 192.168.0.5 - Netmask > 255.255.0.0 - Gateway IP address > 192.168.0.1 - Administrator password > Admin When the instrument is ON, keep the button pressed for at least 5s, but no more than 10s, otherwise the instrument will reboot (refer to the RESET function). After set default, the instrument will perform a reboot automatically (instrument reboot time: 60...90s). Wait until the STAT LED will blink green, then the instrument will be ready to use. • RESET function: instrument reboot. When the instrument is ON, keep the button pressed for at least 10s. The instrument will reboot automatically (instrument reboot time: 60...90s). Wait until the STAT LED will blink green, then the instrument will be ready to use.
	Instrument power supply status (AUX). <ul style="list-style-type: none"> • ON: instrument ON and supplied by auxiliary power. • OFF: instrument OFF or ON and supplied by the backup battery.
	Instrument operating status (bicoloured LED). <ul style="list-style-type: none"> • Green ON: instrument switching on or rebooting in progress. • Continuous green blinking (250ms ON every 3s): instrument normal operating mode. • Green blinking once (1s ON): LED ON when an event occurs. • Slow red blinking (250ms ON every 2s): used memory >85%. • Fast red blinking (500ms ON each second): discharged battery. • Green/red blinking: SET DEFAULT procedure in progress.
	RTC locking status on GPS. <ul style="list-style-type: none"> • ON: RTC locked on GPS signal. • OFF: RTC not locked on GPS signal.

4.2. Rear panel



PART	FUNCTION
1	Instrument label.
2	Protection ground.
3	RS485 port for MODBUS RTU communication.
4	Power supply input and fuse.
5	Symbols:  CE mark;  Product to be disposed according to WEEE directive.
6	Voltage and current measurement inputs. Current inputs change according to the instrument model.
7	Rear Auto MDIX ETHERNET port.
8	Backup battery switch.
9	Connectors for WIFI and GPS antennas.
10	Digital outputs, inputs and analog outputs.

5. INSTALLATION

i Note: the equipment complies with the 89/366/EEC, 73/23/EEC standards and following amendments. However, if not properly installed, it may generate a magnetic field and radio interference. This is why compliance with EMC standards on electromagnetic compatibility is essential.

5.1. Environmental requirements

The environment in which the instrument is installed must satisfy the following features:

- indoor area
- operating temperature between -25°C and $+55^{\circ}\text{C}$
- max humidity 95% (no condensation)
- up to 2000 m over sea-level altitude

i Note: the instrument must not be exposed to sun rays.

5.2. Mounting

The instrument is for panel mount 192x144 DIN size.

- Front part (L x H): 191 x 143 mm (3U)
- Rear part (L x H x D): 183 x 135 x 190 mm (terminals excluded)
- Rear part (L x H x D): 183 x 135 x 206 mm (terminals included)

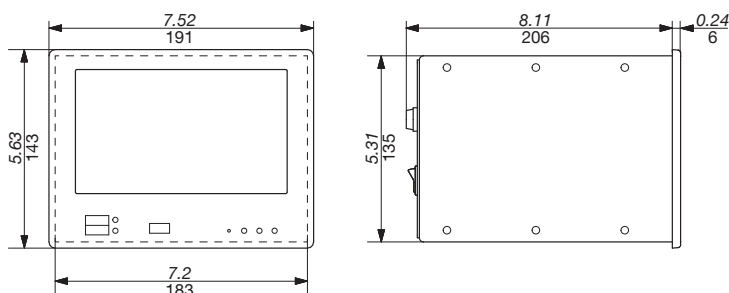

The instrument is for panel mount 192x144 DIN size. For instrument mounting follow the instructions:

1. In the panel, make a cutout 186x138 mm.
2. Make sure that the isolator is on the instrument and the overhanging frame is facing towards the instrument.
3. Insert the instrument through the cutout. The isolator must be between the instrument and the panel.
4. Insert the four fastening accessories with caps into the seats on each instrument side. Tighten the screws until the instrument is fastened.

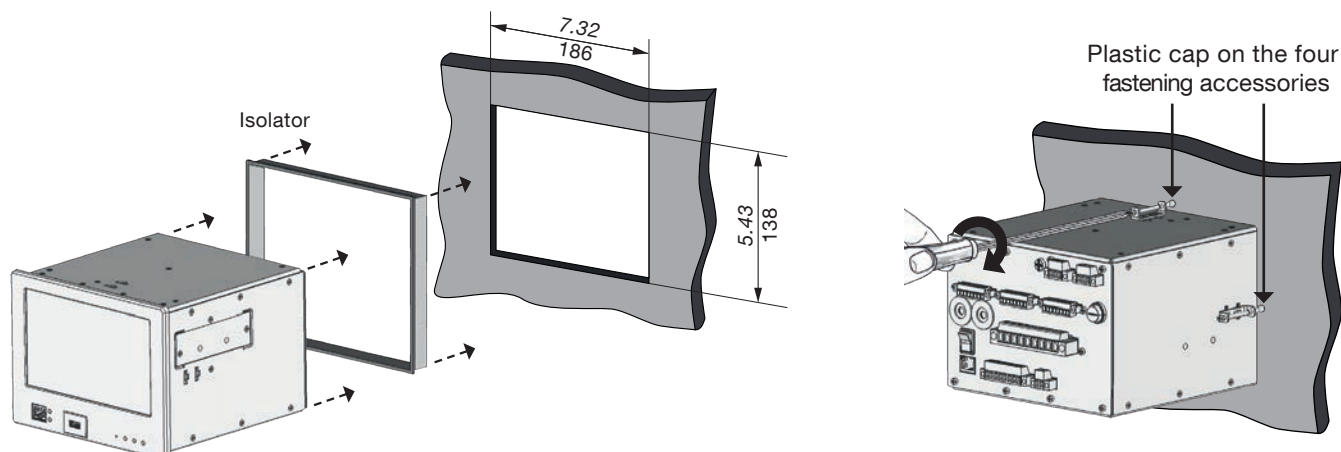

6. ELECTRICAL CONNECTIONS

This section describes how to connect the instrument.

Pay attention to the instrument installation: make sure the installation place is dry and clean as well as easy to reach to make connections.

DANGER! Before making any connection, read and understand the whole chapter "6. Electrical connections", page 10.

WARNING! The instrument is a built-in equipment for fixed installation. Instrument has to be installed in electrical enclosure to ensure protection against electric shock. For this reason, a switch or circuit-breaker must be included in the electrical system for each hazardous voltage circuits. Make sure that the switch or circuit-breaker is suitably located and easily reached is marked as disconnecting device for the equipment.

WARNING! Death, serious injury, or fire hazard could result from improper connection of this instrument. Read carefully and understand this manual before connecting the instrument. Follow all installation and operating instructions while using the instrument. Connection of this instrument must be performed in compliance with any additional safety requirements applicable to your installation. Installation, operation, and maintenance of the instrument must be performed by qualified personnel only. By this term, a professional figure is intended with specific technical qualifications, authorised to act in accordance with the safety standards relating to the dangers of electric current. This person must also have basic first aid training and wear Body Protection Equipment.

The following pictures show the SELV and HAZARDOUS voltage connections according to the instrument model.

Make sure that SELV circuits and HAZARDOUS voltage circuits must be separate from each other. To avoid short-circuit between SELV and active parts, conductors must be maintained close to connections by another means (use of collars, sheath or other similar means).

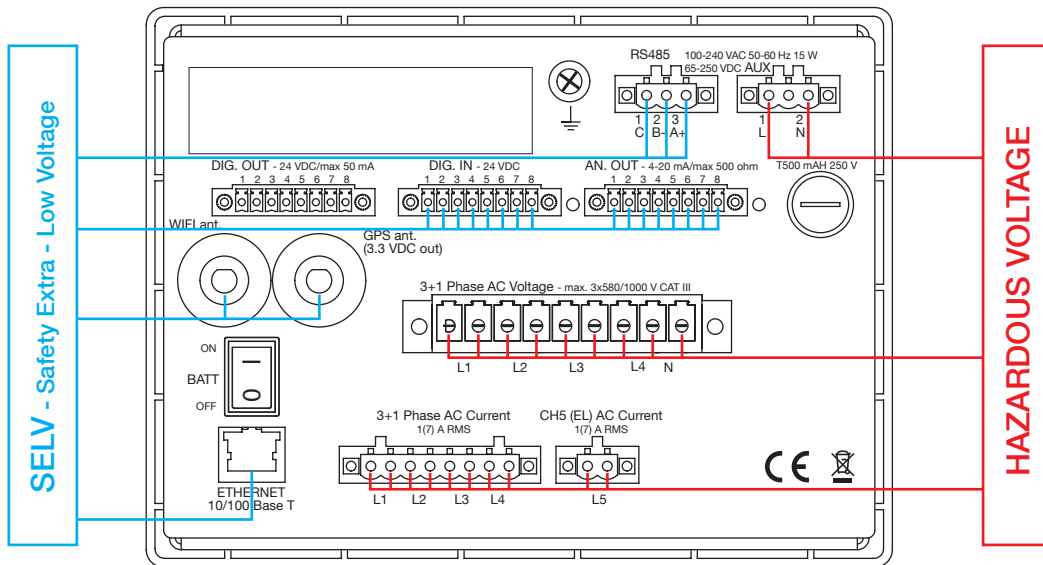



To fulfill the EMC requirements, install the included big ferrites at a maximum 5 cm distance from the device on connection cables of:

- Protective earth terminal
- Power supply terminal
- Current terminal (only CT instrument model)

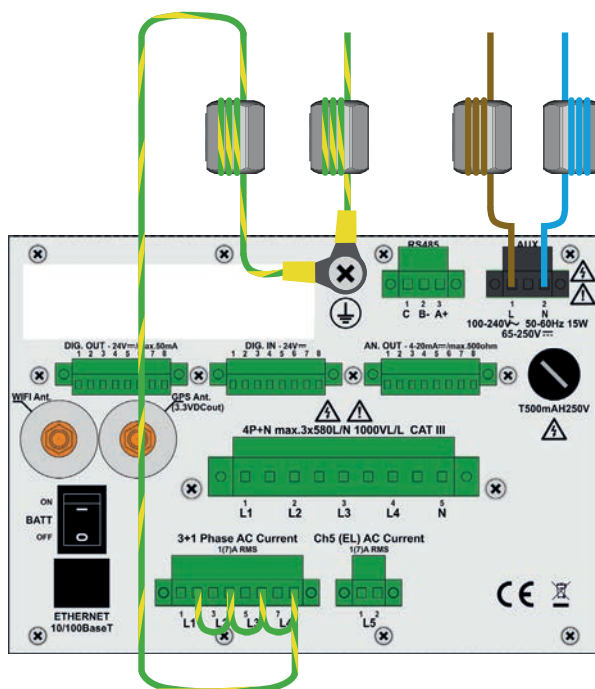
Make sure the cable is wound 3 turns inside the ferrite. If the cable length is not enough, use an extension cable of at least 40 cm about. Please refer to the following picture:



The following features refer to the cables and screwdrivers to be used for instrument connections.

Instrument components	Cable section Ø	Cable stripping  mm	Screwdriver 	Force  Nm
Terminals for: • Auxiliary power supply • RS485 communication port • CT inputs	min 0.20 mm ² max 2.5 mm ²	8 mm	0.8x3.5 mm blade	0.5 Nm
Terminals for: • Digital inputs • Digital outputs • Analog outputs	min 0.14 mm ² max 1.5 mm ²	8 mm	2.5 mm blade	0.25 Nm
Terminals for: • 3 phase AC voltage input • U4 AC voltage input	min 0.20 mm ² max 4 mm ²	8 mm	0.8x3.5 mm blade	0.5 Nm
M6 protective earth	-	-	PH2	0.5 Nm
Terminals fixing	-	-	0.8x3.5 mm blade	0.5 Nm

 **WARNING!** Verify screw state and connection periodically.

6.1. Safety measures

Before making any connections, read carefully this manual and follow the safety measures here described.

- Make sure that the instrument protective earth is properly connected.
- Check that there is no voltage in the lead wires and all electrical sources are disconnected. DO NOT CONNECT powered conductors.
- Always wear protective clothing, including safety glasses and insulated gloves.
- Hands, shoes and floor must be dry.
- Before each use, inspect all cables for breaks or cracks insulation. Replace immediately if defective.
- It is forbidden any use of the product different from the one specified by the Manufacturer documentation.

6.2. Protective earth

 **DANGER!** Before making any connection, read and understand the whole chapter "6. Electrical connections", page 10.

 **DANGER!** For direct current applications (VDC), do not connect the protective earth to the negative pole of the power supply terminal.

 **WARNING!** Use the included lock washer between grounding cable and instrument protective earth. Screw connection shall be secured against loosening.

Connect the grounding cable to the instrument protective earth (M6) and fix the screw and lock washer. Use only eye terminal for the connection.

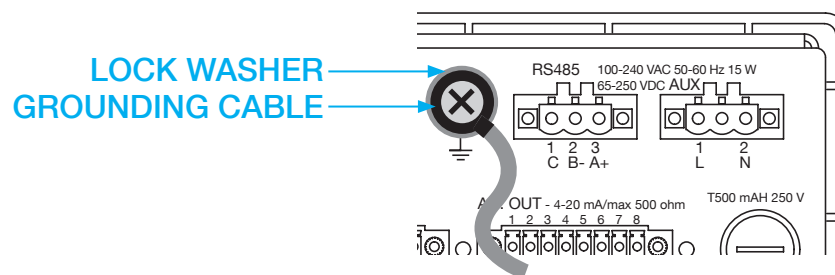

6.3. Measurement inputs



DANGER! Before making any connection, read and understand the whole chapter "6. Electrical connections", page 10.

The instrument is provided with voltage and current inputs. Refer to the following picture and description.

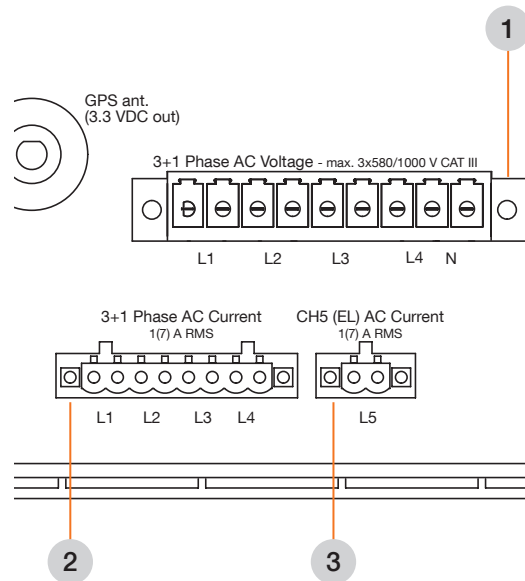

PART	FUNCTION
1	3phases + protective earth + neutral voltage inputs for up to 580 VLN RMS or 1000 VLL RMS direct measurement.
2	Inputs for up to 7 A RMS current measurement by CTs. Current measurement inputs are not designed for direct measurement. Only use CTs.
3	Inputs for up to 7 A RMS Earth Leakage current measurement by CTs. Current measurement inputs are not designed for direct measurement. Only use CTs.

6.3.1. Wiring diagrams



Note:

- If there is no need to measure protective earth (PE), connect the 4th voltage (L4) to the Neutral (N).
- The 4th voltage (L4) is the measurement between Neutral (N) and Protective Earth (PE).
- Connections drawn with ---- are optional and not required for basic 3 phase or 1 phase measurements.

1. 0.5 A gG / 0.5 A class CC fuses.

Direct connection : 3 phases, 4 wires, 4 CT (3.4.4)

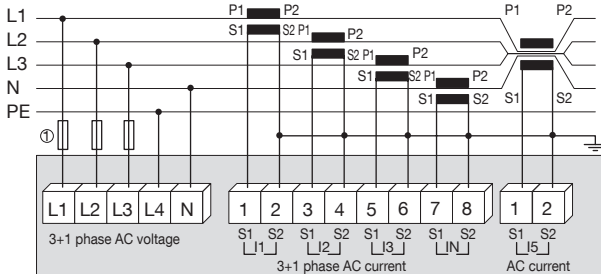

Direct connection : 3 phases, 4 wires, 3 CT (3.4.3)

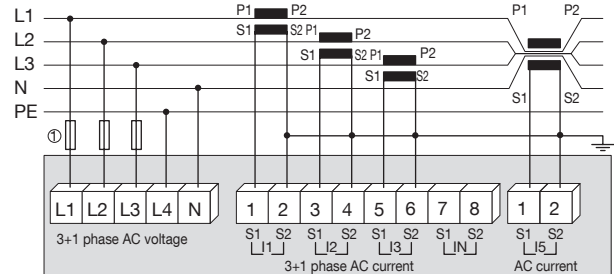

Direct connection : 3 phases, 3 wires, 3 CT (3.3.3)

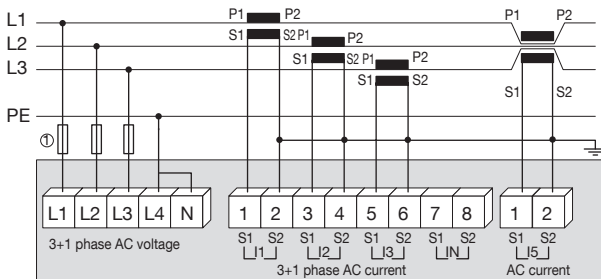

Direct connection : 3 phases, 3 wires, 2 CT (3.3.2)

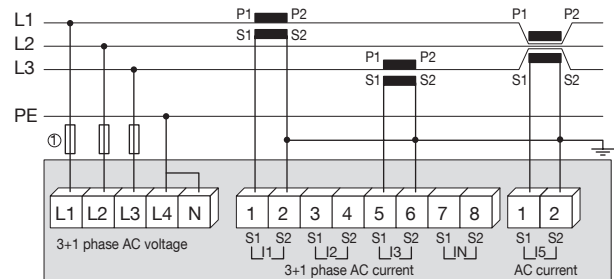

Direct connection : 2 phases + neutral, 3 wires, 3 CT (2.3.3)

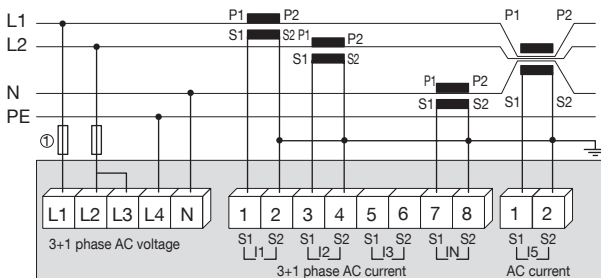

Direct connection : 1 phase, 2 wires, 1 CT (1.2.1)

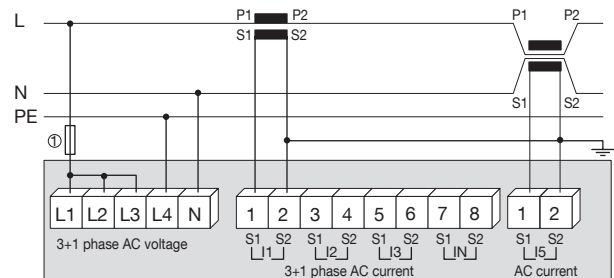

1. 0.5 A gG / 0.5 A class CC fuses.

Connection with VT : 3 phases, 4 wires, 4 CT (3.4.4)

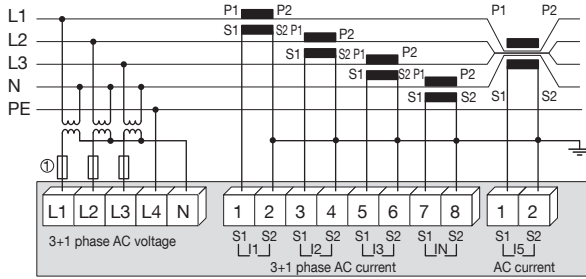

Connection with VT : 3 phases, 4 wires, 3 CT (3.4.3)

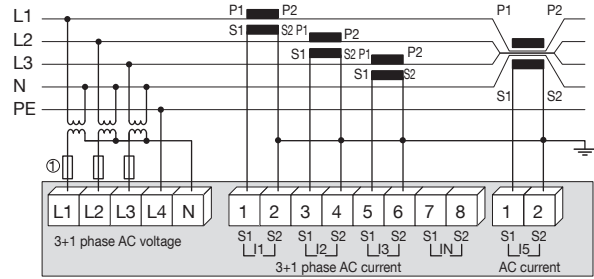

Connection with VT : 3 phases, 3 wires, 3 CT (3.3.3)

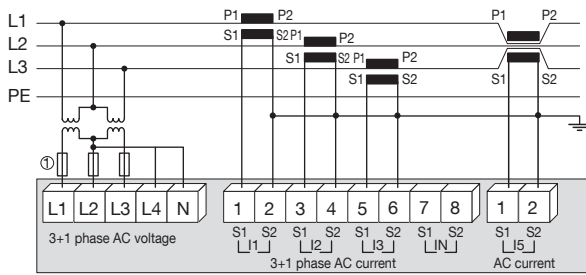

Connection with VT : 3 phases, 3 wires, 2 CT (3.3.2)

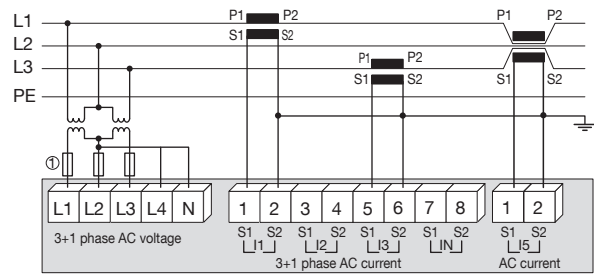

Connection with VT : 2 phases + neutral, 3 wires, 3 CT (2.3.3)

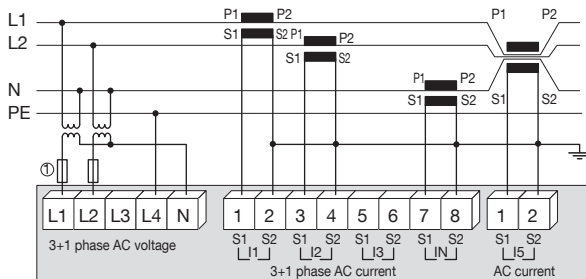

Connection with VT : 1 phase, 2 wires, 1 CT (1.2.1)

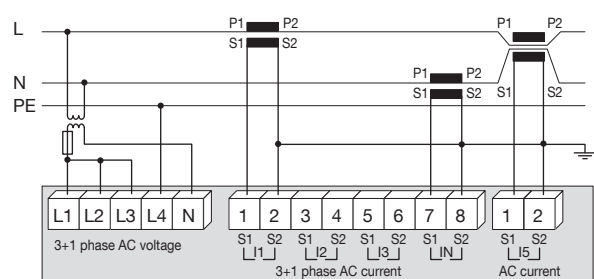

6.4. Power supply

DANGER! Before making any connection, read and understand the whole chapter "6. Electrical connections", page 10.

DANGER! Before making power connections, check if:

- the instrument protective earth is properly connected (\perp). For direct current applications (VDC), do not connect the protective earth to the negative pole of the power supply terminal.
- the mains voltage value corresponds to that shown on the instrument label.

The instrument can be powered directly by 100...240 VAC 50-60 Hz or by 65...250 VDC. On special request the instrument can be provided with 19...60 VDC power supply. The instrument is provided with a T type fuse for the protection against possible voltage overloads.

Refer to the following picture and description.

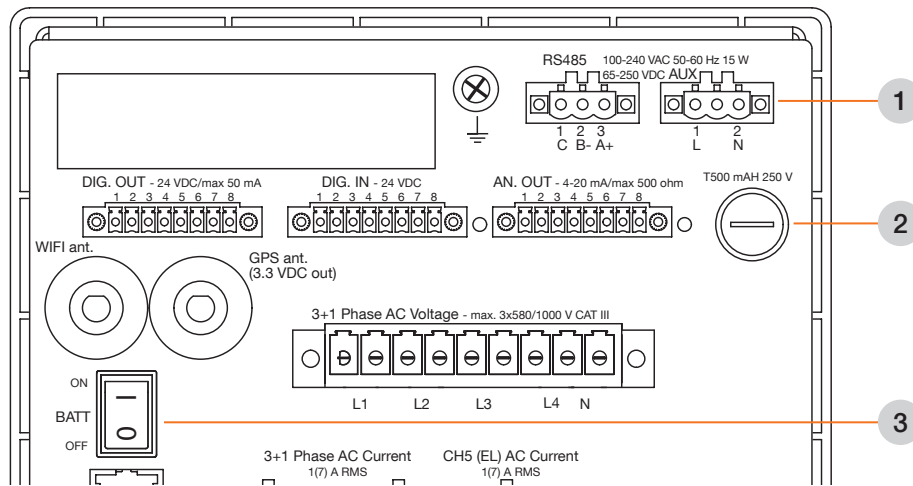

PART	FUNCTION
1	100...240 VAC 50-60 Hz / 65...250 VDC power supply input.
2	Interchangeable fuse, T type delayed from 250 VAC / 500 mA. Breaking capacity: 1500A, 5x20mm.
3	Battery switch (ON/OFF). When OFF, the backup battery is disconnected.

6.4.1. Fuse replacement

WARNING! Assure that all electrical sources are disconnecting and there is no power on the terminals of the device.

The fuse is a protection against voltage overloads and it must be replaced when damaged (e.g. no instrument switching on after a shortcircuit). To replace a fuse, proceed as follows:

1. Make sure that the instrument is powered off, all electrical sources are disconnected and there is no voltage in the lead wires.
2. Unscrew the fuse slot cap.
3. Remove the damaged fuse.
4. Insert a new fuse with the same technical features of the previous one (T500mA/250V).
5. Close the fuse slot by screwing the cap.

WARNING! If the damage occurs most frequently, do not replace the fuse again. Recurred damages mean a defected condition that a fuse replacement cannot solve. Contact the Manufacturer technical support.

6.4.2. Backup battery and switch

The instrument is provided with a backup battery and a battery switch. If the battery switch is ON and an auxiliary power failure occurs, the backup battery will keep the instrument on for 15 minutes.

To understand if the instrument is powered by backup battery, check the instrument front panel: the STAT LED will be operative and the POW LED will be off.

When the instrument is powered by backup battery, the instrument display backlight goes OFF immediately and after a display touch it remains ON for only 30 s, instead of 5 minutes. The following features are automatically disabled for energy saving:

- RS485 port
- WIFI port
- USB port
- Analog outputs

The other measuring and recording functions will remain operative.

 **WARNING!** After an auxiliary power failure, the instrument is keeping on by backup battery for 15 minutes (if backup battery switch is ON). When this period elapsed, the instrument will switch off interrupting all functions.

 **WARNING!** To avoid problems with battery and supply of the device the manufacturer advice to use UPS in the supply, mainly for disturbated network.

 Note: during instrument transport or storage, switch off the backup battery. Remember to switch it on when the instrument will be operative.

6.4.3. Battery replacement

The instrument is provided with a replaceable backup battery. It is suggested to replace battery if during auxiliary power failure it keep the instrument ON less than 15 minutes. For replacement, please contact the Manufacturer.

The battery is custom-built therefore it is forbidden to use a battery not supplied by the Manufacturer.

WARNING! Before replacing battery, be sure that the instrument is powered OFF and disconnected from the electrical system as well as the backup battery switch is OFF.

To replace battery follow the instructions:

1. Make sure that the instrument is powered OFF and disconnected from the electrical system.
2. Remove the screws of the battery cover by using a PH1 cross screwdriver.
3. Remove the battery cover carefully, paying attention not to pull excessively as the battery is installed on the cover and connected to the instrument. An excessive pulling may seriously damage the instrument internal circuits. Pull gently the battery to identify the connector on the cable.
4. Disconnect the old battery and connect the new one.
5. Remove the old battery from battery holder and install the new one, paying attention on the position: on battery cover the screw housing towards display must be side down.
6. Gently push the battery cable inside the battery housing.
7. Reinstall the battery cover and fix it with the screws.

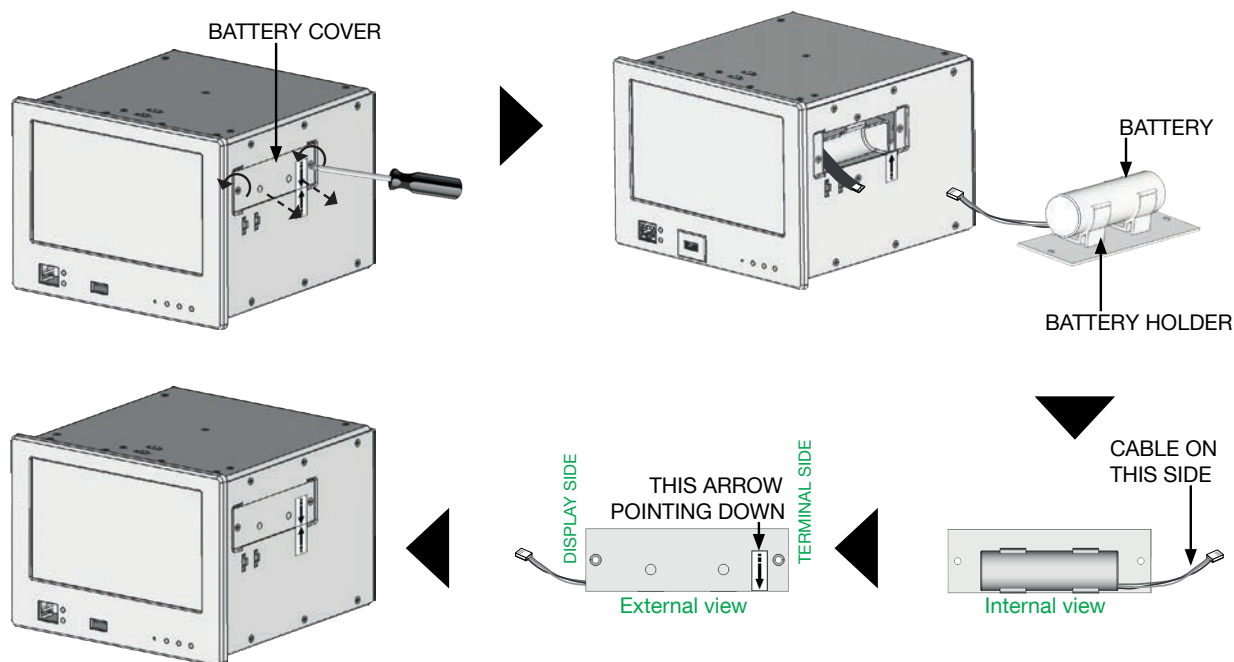

6.5. GPS port

 **DANGER!** Before making any connection, read and understand the whole chapter "6. Electrical connections", page 10.

 **WARNING!** Do not install the GPS antenna in shielded environment or in metal enclosures which can prevent the GPS signal receiving. Install the antenna horizontally, in a place with a direct line of sight to the sky, where the GPS signal quality is good. Make sure that the GPS antenna has been fixed properly.

 **WARNING!** GPS port provides DC voltage for external active antenna power. The output is not protected for shortcircuit, pay attention when connecting GPS antenna. GPS antenna must be connected when the instrument is powered OFF.

 **WARNING!** Before instrument switching on, connect the GPS antenna. If GPS antenna is connected after instrument switching on, RTC synchronisation by GPS is not granted.

 **WARNING!** GPS function is guaranteed with DIRIS Q800 antenna, if not possible to use that one, please contact the technical support. (The installation of other antenna is a risk of the final user).

 **Note:** WIFI & GPS connectors are different type, it is not possible to interchange the antennas.

The instrument internal clock can be synchronised by GPS or server NTP.

To synchronise instrument date&time by GPS, connect the GPS patch antenna (10 m cable) to the instrument and then set the RTC synchronisation to GPS by Web server or by touch screen display. To guarantee the real time clock synchronisation the parameter Auto is suggested, for more detailed see chapter 8.7.1.

Refer to the following picture and description.

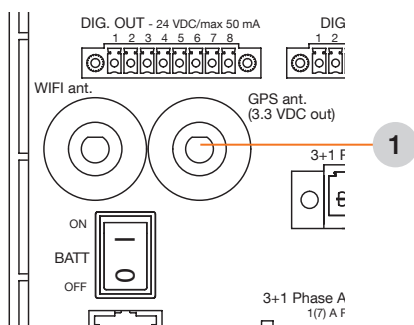

PART	FUNCTION
1	GPS port with SMA connector.

6.6. Communication

 **DANGER!** Before making any connection, read and understand the whole chapter "6. Electrical connections", page 10.

For data reading and programming, the instrument can be connected by using Ethernet (Standard) or also in WI FI network. The instrument data reading is also possible by MODBUS RTU/TCP protocol.

6.6.1. ETHERNET port

The instrument is provided with two Auto MDIX ETHERNET communication ports:

- 1 front port for a quick instrument connection to a PC.
- 1 rear port for data reading and management in remote mode.

Install the included ferrite on the Ethernet cable at a maximum 5 cm distance from the device. Make sure that the Ethernet cable is rolled twice inside the ferrite. Use an Ethernet CAT5 cable (or higher) for ETHERNET port connection. For point to point connection a cross cable is not needed. The ETHERNET communication port gives the possibility to manage the instrument by any PC connected on the ETHERNET network. The instrument communication can be also performed by MODBUS TCP protocol for data reading.

6.6.2. RS485 port

The instrument is provided with an isolated RS485 communication port for instrument data reading by MODBUS RTU protocol in 8N1 format (8 data bits, none parity, 1 stop bit). Data rate (speed) and MODBUS address are programmable (refer to section "8.7.5. Communication", page 97). Refer to the following picture and description.

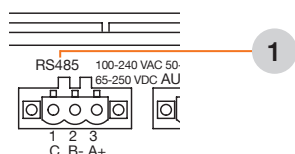

PART	FUNCTION
1	RS485 communication port.

For device network connection, install a terminal resistance ($RT=120...150 \Omega$) on the RS485 converter side and another one on the last device connected on the line. The maximum recommended distance for a connection is 1200m at 9600 bps. For longer distances, lower communication speed (bps), low-attenuation cables or signal repeaters are needed. Refer to the following scheme.

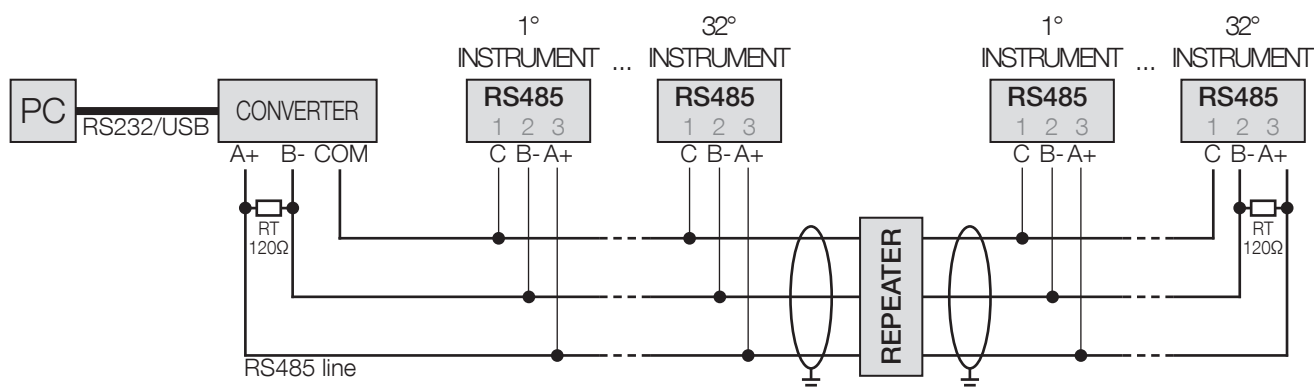

6.6.3. WI FI port

Note: WIFI & GPS connectors are different type, it is not possible to interchange the antennas.

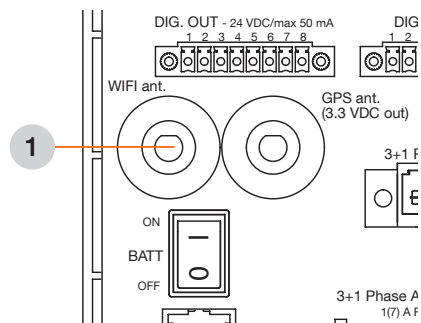

A WIFI port is provided for a quick instrument connection in wireless network. The WIFI function can be enabled in access point or client mode. Connect the provided WIFI antenna and then set the WIFI parameters by Web server or by touch screen display. Refer to the picture and description.

WARNING! Wifi function is guaranteed with DIRIS Q800 antenna, if not possible to use that one, please contact the technical support. (The installation of other antenna is a risk of the final user).

PART	FUNCTION
1	WIFI communication port with SMA-R connector.

6.7. Inputs & outputs



DANGER! Before making any connection, read and understand the whole chapter "6. Electrical connections", page 10.

The instrument is provided with digital inputs, outputs and analog outputs, refer to the following picture and description.

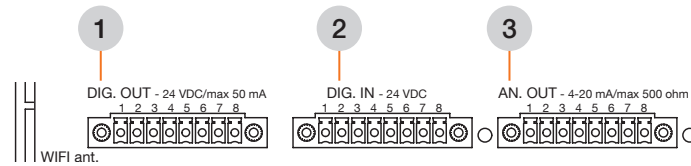

Inputs and outputs (DIG.OUT, DIG.IN, AN.OUT) on products are SELV (safety extra low voltage) according to EN61010-1. Circuits connected on these inputs/outputs have to be isolated by reinforced insulation and respect SELV conditions.

PART	FUNCTION
1	4 channels with 24 VDC optoisolated passive digital outputs for alarm tripping or pulse emission.
2	4 channels with 24 VDC optoisolated digital inputs to acquire logical status of control signals.
3	4 channels with 4...20 mA analog outputs for real time parameter variation transmission.

The following tables show the pinout description for digital inputs and analog outputs. The digital outputs have no polarity.

DIGITAL OUTPUTS		
Pin	Signal	Channel
1	AC/DC	DO1
2	COM	
3	AC/DC	DO2
4	COM	
5	AC/DC	DO3
6	COM	
7	AC/DC	DO4
8	COM	

DIGITAL INPUTS		
Pin	Signal	Channel
1	+	DI1
2	-	
3	+	DI2
4	-	
5	+	DI3
6	-	
7	+	DI4
8	-	

ANALOG OUTPUTS		
Pin	Signal	Channel
1	GND	AO1
2	OUT	
3	GND	AO2
4	OUT	
5	GND	AO3
6	OUT	
7	GND	AO4
8	OUT	

6.8. Instrument switching on



DANGER! Before making any connection, read and understand the whole chapter "6. Electrical connections", page 10.



Note: the instrument switching on is possible only by auxiliary power (AUX). If the backup battery switch is ON but there is no auxiliary power, the instrument will not start.

After making proper connections according to chapter "6. Electrical connections", page 10, switch on the instrument as follows:

1. Power on the electrical control panel, the POW LED and the STAT LED will be green on continuously.
2. Wait until the STAT LED will blink green, then the instrument will be ready to use (60...90 s) and the real time page will be displayed on the screen.

7. INSTRUMENT FUNCTIONS

7.1. Introduction

This chapter contains the description on instrument operation.

The instrument management and setup can be carried out:

- by instrument front panel, using the touch screen display and the USB port (refer to section “7.2. Touch screen display & USB port”, page 23)
- by any PC, using Web server (refer to chapter “8. Web server”, page 54)

Both touch screen and Web server have the same graphic interface. For details on touch screen graphics refer to Web server, chapter “8. Web server”, page 54.

The instrument data reading can be also performed by MODBUS RTU/TCP protocol, according to the used RS485 or Ethernet port.

7.2. Touch screen display & USB port

 Note: the display backlight goes OFF after 5 minutes of display inactivity (i.e. the instrument display is not touched). To bring the backlight ON again, touch the instrument display.

The instrument is provided with a capacitive touch screen display and an USB port on front panel.

The USB port supports USB flash drives up to 32 GB for data transfer or upload.

The touch screen display allows to manage the instrument as well as Web server. The graphic interface is the same in both mode, except for some functions described in the following sections.

7.2.1. Virtual keyboard

When the instrument is managed by display, a virtual keyboard appears automatically everytime a value or character should be entered (e.g. during password request).

7.2.2. Data transfer/upload

 **WARNING!** The instrument supports only up to 32 GB USB flash drives in FAT32 format. USB flash drives with more than 32 GB or hard disks are not supported.

To perform data transfer or instrument upload, an USB flash drive is needed.

In case of recording data transfer, plug in the USB flash drive and then transfer the recordings following the same procedure made on Web server (refer to chapter “8. Web server”, page 54).

In case of instrument firmware update or configuration file upload, first save the corresponding file (PFU or XML) on the USB flash drive. Then, plug it in the instrument and upload the saved file following the same procedure made on Web server (refer to chapter “8. Web server”, page 54).

The display interface firmware cannot be upgraded over USB flash drive, only by Web server.

7.2.3. USB flash drive plugin/eject

 Note: everytime the USB flash drive is plugged in, wait until the instrument will be ready to use (6...12 s).

When an USB flash drive is plugged in the instrument, the  button is automatically displayed on the screen, under the main menu in Recordings or Administration section. This button allows to remove safely the USB flash drive. Make sure to press this button before removing the USB flash drive manually, to avoid corrupted data.

7.3. Measurement monitoring

The following table shows all parameters which can be measured, monitored, recorded and associated to analog & digital outputs.

The “**Wiring mode**” column shows the available parameters (•) according to the set wiring mode.

The “**Applications**” column indicates all parameters which can be displayed, recorded or involved in the event detection process, refer to the following detailed description:

- **Real time:** real time parameters shown in Web server (Real Time & Graphics sections) as well as in Modbus TCP by a reading command.
- **Events:** parameters monitored for event capture.
- **Logging:** parameters programmable according to the logging type: **M**=Min/Avg/Max value logging, **E**=Energy counter logging.
- **Analog outputs:** parameters to be associated to analog outputs.
- **Digital outputs:** parameters to be associated to digital outputs, according to the mode: **A**=Alarm, **P**=Pulse.

All the parameters indicated in the “**Applications**” column are available according to the set wiring mode.

 Note:

- in case of three phase, 3 wire, 2 current insertion (3.3.2), the phase 2 current value (A2) is resulting from a calculation between phase 1 and 3 currents. This condition is indicated on the table, in the dedicated column, by symbol ▲.
- in case of three phase, 4 wire, 3 current insertion (3.4.3), the line 4 current value (I4) is resulting from a calculation between phase 1, 2 and 3 currents (Neutral current). This condition is indicated on the table, in the dedicated column, by symbol △.
- in the table, the ■ symbol indicates the parameters which can be phase or line variables according to the connection. The phase parameters are available for connection with neutral (3.4.3, 1Ph). The line parameters are available only for connection without neutral (3.3.3, 3.3.2).

PARAMETER	WIRING MODES						APPLICATION				
	3.4.4	3.4.3	3.3.3	3.3.2	2.3.3	1.2.1	Real time	Events	Logging	Analog outputs	Digital outputs
Phase 1 to Neutral Voltage (U1N)	•	•			•	•	✓	✓	M	✓	A
Phase 2 to Neutral Voltage (U2N)	•	•			•		✓	✓	M	✓	A
Phase 3 to Neutral Voltage (U3N)	•	•					✓	✓	M	✓	A
Line 1 to 2 Voltage (U12)	•	•	•	•	•		✓	✓	M	✓	A
Line 2 to 3 Voltage (U23)	•	•	•	•			✓	✓	M	✓	A
Line 3 to 1 Voltage (U31)	•	•	•	•			✓	✓	M	✓	A
System Voltage (U Σ)	•	•	•	•	•		✓		M	✓	A
4th Voltage (U4)	•	•	•	•	•	•	✓	✓	M	✓	A
Line 4 to Phase 1 Voltage (U41)	•	•	•	•	•	•	✓	✓	M	✓	A
Line 4 to Phase 2 Voltage (U42)	•	•	•	•	•		✓	✓	M	✓	A
Line 4 to Phase 3 Voltage (U43)	•	•	•	•			✓	✓	M	✓	A
Phase Sequence	•	•	•	•			✓		M		
System Frequency (F)	•	•	•	•	•	•	✓	✓	M	✓	A
Phase 1 Current (I1)	•	•	•	•	•	•	✓	✓	M	✓	A
Phase 2 Current (I2)	•	•	•	▲	•		✓	✓	M	✓	A
Phase 3 Current (I3)	•	•	•	•			✓	✓	M	✓	A
Line 4 Current/Neutral Current (I4/IN)	•	△			•		✓		M	✓	A

PARAMETER	WIRING MODES						APPLICATION				
	3.4.4	3.4.3	3.3.3	3.3.2	2.3.3	1.2.1	Real time	Events	Logging	Analog outputs	Digital outputs
Earth leakage (I_5)	•	•	•	•	•		✓		M	✓	A
System Current (I_Σ)	•	•	•	•	•		✓		M	✓	A
Phase 1 Active Power (P1)	•	•			•	•	✓		M	✓	A
Phase 2 Active Power (P2)	•	•			•		✓		M	✓	A
Phase 3 Active Power (P3)	•	•					✓		M	✓	A
System Active Power (P_Σ)	•	•	•	•	•		✓		M	✓	A
Phase 1 Apparent Power (S1)	•	•			•	•	✓		M	✓	A
Phase 2 Apparent Power (S2)	•	•			•		✓		M	✓	A
Phase 3 Apparent Power (S3)	•	•					✓		M	✓	A
System Apparent Power (S_Σ)	•	•	•	•	•		✓		M	✓	A
Phase 1 Reactive Power (Q1)	•	•			•	•	✓		M	✓	A
Phase 2 Reactive Power (Q2)	•	•			•		✓		M	✓	A
Phase 3 Reactive Power (Q3)	•	•					✓		M	✓	A
System Reactive Power (Q_Σ)	•	•	•	•	•		✓		M	✓	A
Phase 1 True Power Factor (TPF1)	•	•			•	•	✓		M	✓	A
Phase 2 True Power Factor (TPF2)	•	•			•		✓		M	✓	A
Phase 3 True Power Factor (TPF3)	•	•					✓		M	✓	A
System True Power Factor (TPF Σ)	•	•	•	•	•		✓		M	✓	A
Zero Sequence Voltage (U_0)	•	•					✓		M	✓	A
Positive Sequence Voltage (U_1)	•	•					✓		M	✓	A
Negative Sequence Voltage (U_2)	•	•					✓		M	✓	A
Zero Sequence Unbalance Ratio (u_0)	•	•					✓	✓	M	✓	A
Negative Sequence Unbalance Ratio (u_2)	•	•					✓	✓	M	✓	A
Zero Sequence Current (I_0)	•	•					✓		M	✓	A
Positive Sequence Current (I_1)	•	•					✓		M	✓	A
Negative Sequence Current (I_2)	•	•					✓		M	✓	A
Current Zero Sequence Unbalance Ratio (i_0)	•	•					✓		M	✓	A
Current Negative Sequence Unbalance Ratio (i_2)	•	•					✓		M	✓	A
Phase 1 to Neutral Voltage Underdeviation (UdevU1N)	•	•			•	•	✓		M	✓	A
Phase 2 to Neutral Voltage Underdeviation (UdevU2N)	•	•			•		✓		M	✓	A
Phase 3 to Neutral Voltage Underdeviation (UdevU3N)	•	•					✓		M	✓	A
Line 1 to 2 Voltage Underdeviation (UdevU12)	•	•	•	•	•		✓		M	✓	A
Line 2 to 3 Voltage Underdeviation (UdevU23)	•	•	•	•			✓		M	✓	A
Line 3 to 1 Voltage Underdeviation (UdevU31)	•	•	•	•			✓		M	✓	A
Phase 1 to Neutral Voltage Overdeviation (OdevU1N)	•	•			•	•	✓		M	✓	A
Phase 2 to Neutral Voltage Overdeviation (OdevU2N)	•	•			•		✓		M	✓	A
Phase 3 to Neutral Voltage Overdeviation (OdevU3N)	•	•					✓		M	✓	A
Line 1 to 2 Voltage Overdeviation (OdevU12)	•	•	•	•	•		✓		M	✓	A
Line 2 to 3 Voltage Overdeviation (OdevU23)	•	•	•	•			✓		M	✓	A

PARAMETER	WIRING MODES						APPLICATION				
	3.4.4	3.4.3	3.3.3	3.3.2	2.3.3	1.2.1	Real time	Events	Logging	Analog outputs	Digital outputs
Line 3 to 1 Voltage Overdeviation (OdevU31)	•	•	•	•			✓		M	✓	A
Phase 1 to Neutral / Line 1 to 2 Short Term Flicker (Pst1)	■	■	■	■	■	■	✓		M		
Phase 2 to Neutral / Line 2 to 3 Short Term Flicker (Pst2)	■	■	■	■	■		✓		M		
Phase 3 to Neutral / Line 3 to 1 Short Term Flicker (Pst3)	■	■	■	■			✓		M		
Phase 1 to Neutral / Line 1 to 2 Long Term Flicker (Plt1)	■	■	■	■	■	■	✓	✓	M		
Phase 2 to Neutral / Line 2 to 3 Long Term Flicker (Plt2)	■	■	■	■	■		✓	✓	M		
Phase 3 to Neutral / Line 3 to 1 Long Term Flicker (Plt3)	■	■	■	■			✓	✓	M		
Phase 1 to Neutral Voltage Total Harmonic Distortion (THDU1N)	•	•			•	•	✓	✓	M	✓	A
Phase 1 to Neutral Voltage Odd Harmonic Distortion (oHDU1N)	•	•			•	•	✓		M	✓	A
Phase 1 to Neutral Voltage Even Harmonic Distortion (eHDU1N)	•	•			•	•	✓		M	✓	A
Phase 2 to Neutral Voltage Total Harmonic Distortion (THDU2N)	•	•			•		✓	✓	M	✓	A
Phase 2 to Neutral Voltage Odd Harmonic Distortion (oHDU2N)	•	•			•		✓		M	✓	A
Phase 2 to Neutral Voltage Even Harmonic Distortion (eHDU2N)	•	•			•		✓		M	✓	A
Phase 3 to Neutral Voltage Total Harmonic Distortion (THDU3N)	•	•			•		✓	✓	M	✓	A
Phase 3 to Neutral Voltage Odd Harmonic Distortion (oHDU3N)	•	•			•		✓		M	✓	A
Phase 3 to Neutral Voltage Even Harmonic Distortion (eHDU3N)	•	•			•		✓		M	✓	A
Line 1 to 2 Voltage Total Harmonic Distortion (THDU12)	•	•	•	•	•		✓	✓	M	✓	A
Line 1 to 2 Voltage Odd Harmonic Distortion (oHDU12)	•	•	•	•	•		✓		M	✓	A
Line 1 to 2 Voltage Even Harmonic Distortion (eHDU12)	•	•	•	•	•		✓		M	✓	A
Line 2 to 3 Voltage Total Harmonic Distortion (THDU23)	•	•	•	•			✓	✓	M	✓	A
Line 2 to 3 Voltage Odd Harmonic Distortion (oHDU23)	•	•	•	•			✓		M	✓	A
Line 2 to 3 Voltage Even Harmonic Distortion (eHDU23)	•	•	•	•			✓		M	✓	A
Line 3 to 1 Voltage Total Harmonic Distortion (THDU31)	•	•	•	•			✓	✓	M	✓	A
Line 3 to 1 Voltage Odd Harmonic Distortion (oHDU31)	•	•	•	•			✓		M	✓	A
Line 3 to 1 Voltage Even Harmonic Distortion (eHDU31)	•	•	•	•			✓		M	✓	A
Phase 1 Current Total Harmonic Distortion (THDI1)	•	•	•	•	•	•	✓		M	✓	A
Phase 1 Current Total Demand Distortion (TDDI1)	•	•	•	•	•	•	✓		M	✓	A
Phase 1 Current Odd Demand Distortion (oDDI1)	•	•	•	•	•	•	✓		M	✓	A
Phase 1 Current Even Demand Distortion (eDDI1)	•	•	•	•	•	•	✓		M	✓	A
Phase 2 Current Total Harmonic Distortion (THDI2)	•	•	•		•		✓		M	✓	A
Phase 2 Current Total Demand Distortion (TDDI2)	•	•	•		•		✓		M	✓	A
Phase 2 Current Odd Demand Distortion (oDDI2)	•	•	•		•		✓		M	✓	A
Phase 2 Current Even Demand Distortion (eDDI2)	•	•	•		•		✓		M	✓	A
Phase 3 Current Total Harmonic Distortion (THDI3)	•	•	•	•			✓		M	✓	A
Phase 3 Current Total Demand Distortion (TDDI3)	•	•	•	•			✓		M	✓	A
Phase 3 Current Odd Demand Distortion (oDDI3)	•	•	•	•			✓		M	✓	A
Phase 3 Current Even Demand Distortion (eDDI3)	•	•	•	•			✓		M	✓	A
Phase 4 Current Total Harmonic Distortion (THDI4)	•				•		✓			✓	A
Phase 1 Displacement Power Factor (DPF1)	•	•			•	•	✓		M	✓	A

PARAMETER	WIRING MODES						APPLICATION				
	3.4.4	3.4.3	3.3.3	3.3.2	2.3.3	1.2.1	Real time	Events	Logging	Analog outputs	Digital outputs
Phase 2 Displacement Power Factor (DPF2)	•	•			•		✓		M	✓	A
Phase 3 Displacement Power Factor (DPF3)	•	•					✓		M	✓	A
Phase 1 K Factor (K1)	•	•	•	•	•	•	✓		M	✓	A
Phase 2 K Factor (K2)	•	•	•		•		✓		M	✓	A
Phase 3 K Factor (K3)	•	•	•	•			✓		M	✓	A
Phase 1 to Neutral Mains Signalling 1 (U1N-MS1)	•	•			•	•	✓	✓	M		
Phase 2 to Neutral Mains Signalling 1 (U2N-MS1)	•	•			•		✓	✓	M		
Phase 3 to Neutral Mains Signalling 1 (U3N-MS1)	•	•					✓	✓	M		
Phase 1 to Neutral Mains Signalling 2 (U1N-MS2)	•	•			•	•	✓	✓	M		
Phase 2 to Neutral Mains Signalling 2 (U2N-MS2)	•	•			•		✓	✓	M		
Phase 3 to Neutral Mains Signalling 2 (U3N-MS2)	•	•					✓	✓	M		
Phase 1 to Neutral Mains Signalling 3 (U1N-MS3)	•	•			•	•	✓	✓	M		
Phase 2 to Neutral Mains Signalling 3 (U2N-MS3)	•	•			•		✓	✓	M		
Phase 3 to Neutral Mains Signalling 3 (U3N-MS3)	•	•					✓	✓	M		
Phase 1 to Neutral Mains Signalling 4 (U1N-MS4)	•	•			•	•	✓	✓	M		
Phase 2 to Neutral Mains Signalling 4 (U2N-MS4)	•	•			•		✓	✓	M		
Phase 3 to Neutral Mains Signalling 4 (U3N-MS4)	•	•					✓	✓	M		
Phase 1 to Neutral Mains Signalling 5 (U1N-MS5)	•	•			•	•	✓	✓	M		
Phase 2 to Neutral Mains Signalling 5 (U2N-MS5)	•	•			•		✓	✓	M		
Phase 3 to Neutral Mains Signalling 5 (U3N-MS5)	•	•					✓	✓	M		
Phase 1 Current Demand (I1DMD)	•	•	•	•	•	•	✓		D		A
Phase 2 Current Demand (I2DMD)	•	•	•	▲	•		✓		D		A
Phase 3 Current Demand (I3DMD)	•	•	•	•			✓		D		A
Line 4 Current Demand (I4DMD)	•	•			•		✓		D		A
Line 5 (Earth Leakage) Demand (I5DMD)	•	•	•	•	•		✓		D		A
System Current Demand (I Σ DMD)	•	•	•	•	•		✓		D		A
Phase 1 Positive Active Power Demand (+P1DMD)	•	•			•	•	✓		D		A
Phase 1 Negative Active Power Demand (-P1DMD)	•	•			•	•	✓		D		A
Phase 2 Positive Active Power Demand (+P2DMD)	•	•			•		✓		D		A
Phase 2 Negative Active Power Demand (-P2DMD)	•	•			•		✓		D		A
Phase 3 Positive Active Power Demand (+P3DMD)	•	•					✓		D		A
Phase 3 Negative Active Power Demand (-P3DMD)	•	•					✓		D		A
System Positive Active Power Demand (+P Σ DMD)	•	•	•	•	•		✓		D		A
System Negative Active Power Demand (-P Σ DMD)	•	•	•	•	•		✓		D		A
Phase 1 Positive Reactive Power Demand (+Q1DMD)	•	•			•	•	✓		D		A
Phase 1 Negative Reactive Power Demand (-Q1DMD)	•	•			•	•	✓		D		A
Phase 2 Positive Reactive Power Demand (+Q2DMD)	•	•			•		✓		D		A
Phase 2 Negative Reactive Power Demand (-Q2DMD)	•	•			•		✓		D		A
Phase 3 Positive Reactive Power Demand (+Q3DMD)	•	•					✓		D		A

PARAMETER	WIRING MODES						APPLICATION				
	3.4.4	3.4.3	3.3.3	3.3.2	2.3.3	1.2.1	Real time	Events	Logging	Analog outputs	Digital outputs
Phase 3 Negative Reactive Power Demand (-Q3DMD)	•	•					✓		D		A
System Positive Reactive Power Demand (+Q Σ DMD)	•	•	•	•	•		✓		D		A
System Negative Reactive Power Demand (-Q Σ DMD)	•	•	•	•	•		✓		D		A
Phase 1 Positive Apparent Power Demand (+S1DMD)	•	•			•	•	✓		D		A
Phase 1 Negative Apparent Power Demand (-S1DMD)	•	•			•	•	✓		D		A
Phase 2 Positive Apparent Power Demand (+S2DMD)	•	•			•		✓		D		A
Phase 2 Negative Apparent Power Demand (-S2DMD)	•	•			•		✓		D		A
Phase 3 Positive Apparent Power Demand (+S3DMD)	•	•					✓		D		A
Phase 3 Negative Apparent Power Demand (-S3DMD)	•	•					✓		D		A
System Positive Apparent Power Demand (+S Σ DMD)	•	•	•	•	•		✓		D		A
System Negative Apparent Power Demand (-S Σ DMD)	•	•	•	•	•		✓		D		A
Phase 1 Positive True Power Factor Demand (+TPF1DMD)	•	•			•	•	✓		D		A
Phase 1 Negative True Power Factor Demand (-TPF1DMD)	•	•			•	•	✓		D		A
Phase 2 Positive True Power Factor Demand (+TPF2DMD)	•	•			•		✓		D		A
Phase 2 Negative True Power Factor Demand (-TPF2DMD)	•	•			•		✓		D		A
Phase 3 Positive True Power Factor Demand (+TPF3DMD)	•	•					✓		D		A
Phase 3 Negative True Power Factor Demand (-TPF3DMD)	•	•					✓		D		A
System Positive True Power Factor Demand (+TPF Σ DMD)	•	•	•	•	•		✓		D		A
System Negative True Power Factor Demand (-TPF Σ DMD)	•	•	•	•	•		✓		D		A
Phase 1 Current Demand MAX (I1DMDMAX)	•	•	•	•	•	•	S				
Phase 2 Current Demand MAX (I2DMDMAX)	•	•	•	▲	•		S				
Phase 3 Current Demand MAX (I3DMDMAX)	•	•	•	•			S				
Line 4 Current Demand MAX (I4DMDMAX)	•	•					S				
Line 5 (Earth Leakage) Demand MAX (I5DMDMAX)	•	•	•	•	•		S				
System Current Demand MAX (I Σ DMDMAX)	•	•	•	•	•		S				
Phase 1 Positive Active Power Demand MAX (+P1DMDMAX)	•	•			•	•	S				
Phase 1 Negative Active Power Demand MAX (-P1DMDMAX)	•	•			•	•	S				
Phase 2 Positive Active Power Demand MAX (+P2DMDMAX)	•	•			•		S				
Phase 2 Negative Active Power Demand MAX (-P2DMDMAX)	•	•			•		S				
Phase 3 Positive Active Power Demand MAX (+P3DMDMAX)	•	•					S				
Phase 3 Negative Active Power Demand MAX (-P3DMDMAX)	•	•					S				
System Positive Active Power Demand MAX (+P Σ DMDMAX)	•	•	•	•	•		S				
System Negative Active Power Demand MAX (-P Σ DMDMAX)	•	•	•	•	•		S				
Phase 1 Positive Reactive Power Demand MAX (+Q1DMDMAX)	•	•			•	•	S				
Phase 1 Negative Reactive Power Demand MAX (-Q1DMDMAX)	•	•			•	•	S				
Phase 2 Positive Reactive Power Demand MAX (+Q2DMDMAX)	•	•			•		S				
Phase 2 Negative Reactive Power Demand MAX (-Q2DMDMAX)	•	•			•		S				
Phase 3 Positive Reactive Power Demand MAX (+Q3DMDMAX)	•	•					S				
Phase 3 Negative Reactive Power Demand MAX (-Q3DMDMAX)	•	•					S				

PARAMETER	WIRING MODES						APPLICATION				
	3.4.4	3.4.3	3.3.3	3.3.2	2.3.3	1.2.1	Real time	Events	Logging	Analog outputs	Digital outputs
System Positive Reactive Power Demand MAX (+Q Σ DMDMAX)	•	•	•	•	•		S				
System Negative Reactive Power Demand MAX (-Q Σ DMDMAX)	•	•	•	•	•		S				
Phase 1 Positive Apparent Power Demand MAX (+S1DMDMAX)	•	•			•	•	S				
Phase 1 Negative Apparent Power Demand MAX (-S1DMDMAX)	•	•			•	•	S				
Phase 2 Positive Apparent Power Demand MAX (+S2DMDMAX)	•	•			•		S				
Phase 2 Negative Apparent Power Demand MAX (-S2DMDMAX)	•	•			•		S				
Phase 3 Positive Apparent Power Demand MAX (+S3DMDMAX)	•	•					S				
Phase 3 Negative Apparent Power Demand MAX (-S3DMDMAX)	•	•					S				
System Positive Apparent Power Demand MAX (+S Σ DMDMAX)	•	•	•	•	•		S				
System Negative Apparent Power Demand MAX (-S Σ DMDMAX)	•	•	•	•	•		S				
Phase 1 Positive True Power Factor Demand MAX (+TPF1DMDMAX)	•	•			•	•	S				
Phase 1 Negative True Power Factor Demand MAX (-TPF1DMDMAX)	•	•			•	•	S				
Phase 2 Positive True Power Factor Demand MAX (+TPF2DMDMAX)	•	•			•		S				
Phase 2 Negative True Power Factor Demand MAX (-TPF2DMDMAX)	•	•			•		S				
Phase 3 Positive True Power Factor Demand MAX (+TPF3DMDMAX)	•	•					S				
Phase 3 Negative True Power Factor Demand MAX (-TPF3DMDMAX)	•	•					S				
System Positive True Power Factor Demand MAX (+TPF Σ DMDMAX)	•	•	•	•	•		S				
System Negative True Power Factor Demand MAX (-TPF Σ DMDMAX)	•	•	•	•	•		S				
Phase 1 to Neutral Voltage Harmonics & Interharmonics (U1N Ha&IHa)	•	•			•	•	✓		M	✓	A
Phase 2 to Neutral Voltage Harmonics & Interharmonics (U2N Ha&IHa)	•	•			•		✓		M	✓	A
Phase 3 to Neutral Voltage Harmonics & Interharmonics (U3N Ha&IHa)	•	•					✓		M	✓	A
Line 1 to 2 Voltage Harmonics & Interharmonics (U12 Ha&IHa)	•	•	•	•	•		✓		M	✓	A
Line 2 to 3 Voltage Harmonics & Interharmonics (U23 Ha&IHa)	•	•	•	•			✓		M	✓	A
Line 3 to 1 Voltage Harmonics & Interharmonics (U31 Ha&IHa)	•	•	•	•			✓		M	✓	A
Phase 1 Current Harmonics & Interharmonics (I1 Ha&IHa)	•	•	•	•	•	•	✓		M	✓	A
Phase 2 Current Harmonics & Interharmonics (I2 Ha&IHa)	•	•	•		•		✓		M	✓	A
Phase 3 Current Harmonics & Interharmonics (I3 Ha&IHa)	•	•	•	•			✓		M	✓	A
U2 Angle Relative to U1 - On Fundamental (AngU1U2)	•	•	•	•	•		✓			✓	A
U3 Angle Relative to U1 - On Fundamental (AngU1U3)	•	•	•	•			✓			✓	A
U4 Angle Relative to U1 - On Fundamental (AngU1U4)	•	•	•	•	•	•	✓			✓	A
I1 Angle Relative to U1 - On Fundamental (AngU1I1)	•	•	•	•	•	•	✓			✓	A
I2 Angle Relative to U1 - On Fundamental (AngU1I2)	•	•	•	•	•		✓			✓	A
I3 Angle Relative to U1 - On Fundamental (AngU1I3)	•	•	•	•			✓			✓	A
I4 Angle Relative to U1 - On Fundamental (AngU1I4)	•	•			•	•	✓			✓	A
I5 Angle Relative to U1 - On Fundamental (AngU1I5)	•	•	•	•	•	•	✓			✓	A
Imported Active Energy (+kWh)	•	•	•	•	•	•	✓	✓	E		P
Imported Apparent Energy - IND/LAGG. (+kVAh-L)	•	•	•	•	•	•	✓	✓	E		P
Imported Apparent Energy - CAP/LEAD. (+kVAh-C)	•	•	•	•	•	•	✓	✓	E		P
Imported Reactive Energy - IND/LAGG. (+kvarh-L)	•	•	•	•	•	•	✓	✓	E		P

PARAMETER	WIRING MODES						APPLICATION				
	3.4.4	3.4.3	3.3.3	3.3.2	2.3.3	1.2.1	Real time	Events	Logging	Analog outputs	Digital outputs
Imported Reactive Energy - CAP/LEAD. (+kvarh-C)	•	•	•	•	•	•	✓	✓	E		P
Exported Active Energy (-kWh)	•	•	•	•	•	•	✓	✓	E		P
Exported Apparent Energy - IND/LAGG. (-kVAh-L)	•	•	•	•	•	•	✓	✓	E		P
Exported Apparent Energy - CAP/LEAD. (-kVAh-C)	•	•	•	•	•	•	✓	✓	E		P
Exported Reactive Energy - IND/LAGG. (-kvarh-L)	•	•	•	•	•	•	✓	✓	E		P
Exported Reactive Energy - CAP/LEAD. (-kvarh-C)	•	•	•	•	•	•	✓	✓	E		P

The following table shows all real time parameters which are available for all device versions only in MODBUS RTU/TCP by a reading command, according to the set wiring mode.

PARAMETER	WIRING MODES					
	3.4.4	3.4.3	3.3.3	3.3.2	2.3.3	1.2.1
Phase 1 to Neutral Voltage Harmonics & Interharmonics angle (U1N Ha&IHa-Ang)	•	•			•	•
Phase 2 to Neutral Voltage Harmonics & Interharmonics angle (U2N Ha&IHa-Ang)	•	•			•	
Phase 3 to Neutral Voltage Harmonics & Interharmonics angle (U3N Ha&IHa-Ang)	•	•				
Line 1 to 2 Voltage Harmonics & Interharmonics angle (U12 Ha&IHa-Ang)	•	•	•	•	•	
Line 2 to 3 Voltage Harmonics & Interharmonics angle (U23 Ha&IHa-Ang)	•	•	•	•		
Line 3 to 1 Voltage Harmonics & Interharmonics angle (U31 Ha&IHa-Ang)	•	•	•	•		
Phase 1 Current Harmonics & Interharmonics angle (I1 Ha&IHa-Ang)	•	•	•	•	•	•
Phase 2 Current Harmonics & Interharmonics angle (I2 Ha&IHa-Ang)	•	•	•		•	
Phase 3 Current Harmonics & Interharmonics angle (I3 Ha&IHa-Ang)	•	•	•	•	•	
Phase 1 Active Power Harmonics & Interharmonics (P1 Ha&IHa)	•	•			•	•
Phase 2 Active Power Harmonics & Interharmonics (P2 Ha&IHa)	•	•			•	
Phase 3 Active Power Harmonics & Interharmonics (P3 Ha&IHa)	•	•				
Phase 1 Reactive Power Harmonics & Interharmonics (Q1 Ha&IHa)	•	•			•	•
Phase 2 Reactive Power Harmonics & Interharmonics (Q2 Ha&IHa)	•	•			•	
Phase 3 Reactive Power Harmonics & Interharmonics (Q3 Ha&IHa)	•	•				

7.4. Wiring modes (voltages/currents)

 Note: the set wiring mode has no effect on 4th Voltage (U4), Line 4 Current (I4) and Line 5 Current (I5) inputs.

For a correct instrument operation, select the wiring mode according to the real connection. If the selected mode is different from the real instrument wiring, the measurements will be miscalculated.

Available wiring modes:

- 3.4.4=Three phases, 4 wires, 4 currents (4NBL)
- 3.4.3=Three phases, 4 wires, 3 currents (4NBL)
- 3.3.3=Three phases, 3 wires, 3 currents (3NBL)
- 3.3.2=Three phases, 3 wires, 2 currents (3NBL)
- 2.3.3=Two phases, 3 wires, 2 currents (2NBL)
- 1.2.1=Single phase, 2 wires, 1 current (1BL)

For wiring diagrams refer to section “6.3.1. Wiring diagrams”, page 14

7.5. Internal clock synchronisation

The instrument internal clock can be set manually or by automatic NTP or GPS synchronisation. For an accurate event analysis, it is suggested to set the GPS synchronisation.

If the automatic synchronisation is enabled, but there is no GPS signal, the instrument can perform an automatic NTP synchronisation till the GPS signal will be available again (Instrument retries every second the GPS synchronisation). The NTP synchronisation accuracy depends on the network latency period.

The DST (Daylight Saving Time) function is available according to the set timezone and clock. When the DST occurs, the recording files in progress are automatically closed and new recording files are opened, this process takes about 2 s. To avoid the automatic DST and Timezone functions, set **Timezone's Region** to **Atlantic** and **Timezone's City** to **Reykjavik**.

7.6. Mains signalling

The instrument can detect the mains signalling voltage on the supply voltage. The mains signalling can be detected and displayed in Web server in one of the following methods, according to the selection:

- continuously at 10/12 cycle (200 ms @ 50/60 Hz)
- only after threshold overcoming, displaying the maximum value of the preset period

After method selection, up to 5 mains signalling can be programmed at different frequencies. The detected values are automatically displayed in Real Time page.

7.7. Demand values

The instrument calculates the demand values of currents, powers and true power factors, which are arithmetical average values calculated on a programmable time period, and with specific refresh rate according to the selected mode and period(s). For the Demand values calculation the 10/12 cycle values are used.

For each parameter separate demand values are calculated for positive and negative values (currents excluded). Positive demand means that, in the average value calculation, only the positive values of the specific parameter are considered. In similar way, the negative demand values will contain only the negative realtime values.

It is possible to set different type of calculation:

- Fixed=the demand values are calculated on the fixed period and they are refreshed at the end of the calculation period (fixed window).
- Sliding=the demand values are calculated on the fixed period and they are refreshed each second or minute according to the set period (sliding window).
- Rolling=similar as sliding, the demand values are calculated on the fixed period and they are refreshed according to the set subperiod (rolling window).

The calculation period can be set in range 1...60 minutes, and the subperiod must be a submultiple of the main calculation period. In case of sliding window, the refresh rate is 1 s if the main period is lower or equal to 5 min, and 1 min if the main period is higher than 5 min.



WARNING! If the Demand Mode, Demand Period or Subperiod is modified, the instrument will reset the Demand, Demand MAX values, restart the Demand Period and start a new LOG file.

7.8. Recording functions

The instrument can monitor the measurements and record different data according to the set recording type. Available recording types:

- **Events:** event capture at threshold overtake; in case of fast frequency event, the event can be triggered also by manual mode
- **Min/Avg/Max:** LOG recording containing the Min/Avg/Max values stored at a preset rate
- **Frequency LOG:** recording containing the frequency values stored at a preset rate
- **Energy counter LOG:** LOG recording containing the energy counters stored at a preset rate
- **Inputs LOG:** recording containing digital input status changes
- **Functional LOG:** LOG recording containing instrument operating status
- **Demand LOG:** LOG recording containing the demand values stored at the demand calculation rate
- **Demand MAX:** saving of maximum (peak) values of the demand with relative timestamp (not a LOG function)

Functional LOG is automatically generated by instrument status. Demand MAX values can only be displayed and they are continuously updated. On the contrary, the recording of Events, Min/Avg/Max and Energy counter LOG must be enabled/programmed in the instrument setup. If digital inputs are previously enabled, input recording is automatically stored when input status changes.



Note: each recording file is automatically closed and a new one is generated when:

- its maximum limit size is reached (10 MB).
- the date or time is changed manually or automatically, e.g. switching on DST (except for Functional LOG).

7.9. Event recording

The instrument can record different event types everytime an out of threshold value is detected (if thresholds are previously enabled). The recorded events can be fast or slow.

A fast event is a variation detected during the RMS value monitoring at a 1/2 wave rate (10 ms @50 Hz).

This detected data is recorded, according to the fast event type, in two different files:

- **CSV (Comma Separated Values):** it contains all the main information on the detected fast events and additional details
- **PQDIF (Power Quality Data Interchange Format):** it contains 1/2 cycle RMS values, 64 samples/wave captured during the event, tag (MAGDURTIME) and additional channels containing information on the event

To detect the fast events, enable and set thresholds for the parameter to be monitored, as well as wave number to be captured.

A slow event is a variation detected during the value monitoring on a long period (e.g. 10 min or 2 h). The slow event data are recorded in different CSV files, containing all main information on each detected event. To detect slow events, enable and set thresholds for the parameter to be monitored.

All recorded events can be displayed, downloaded or deleted by touch screen or Web server.

7.9.1. Fast 3phase voltage events



WARNING! Wrong recording settings can generate files with a big amount of unnecessary data, filling up the memory space. Threshold values and number of cycles to be recorded must be set with proper values according to the monitoring application.



Note:

- in the fast voltage events, only the three phase voltage parameters are involved (U1N, U2N, U3N, U12, U23, U31), according to the wiring mode. The 4th voltage (U4) is not considered.
- according to the set wiring mode, the monitored and recorded parameters change as follows: in 3.4.3 and 1Ph phase-neutral parameters monitored/recorded; in 3.3.3 and 3.3.2 line-line parameters monitored/recorded.

The fast voltage events are sudden sag, swell, interruptions and transients of phase-neutral or line voltage, according to the set wiring mode.

For sags, swells and interruptions the voltages are monitored calculating the RMS at a 1/2 wave rate (10 ms @50 Hz). For transients monitoring consecutive sample values are analysed.

For sags, swells and interruptions recording, the system compares the measured 1/2 cycles RMS values with 3 threshold levels. These thresholds can be programmed and enabled independently from other type of triggers. For voltage transients recording, 2 threshold values must be overtaken: level and duration. The 1'st condition is when the absolute difference of 2 consecutive samples are higher than the set threshold level. The 2'nd condition is to have a time duration higher than the set duration threshold, with consecutive samples out of range. These thresholds can be programmed and enabled together with other type of triggers. The sag and swell events are recorded when at least one of the phases/lines exceeds the threshold. The interruption events are recorded when all phases/lines exceed the interruption threshold.

The transient events are recorded when at least one of the phases/lines exceeds the set level and time thresholds. The level difference can be positive or negative which means that the transient can occur in both directions on the wave. The voltage transient capture works in parallel with all other event monitoring (e.g. voltage sag, swell, interruption, ...).

For more details refer to the EN 50160 standard.

The event main data is stored in a CSV file. If the functional parameters change (i.e. parameters which modify the measurement format, e.g. wiring mode, CT, FSA, ...), a new CSV file is generated automatically. For each detected event, raw data (1/2 cycle RMS value trend and voltage waveform) is recorded in a PQDIF file. If the functional parameters change, a new PQDIF file is generated automatically.

CSV file content for fast voltage events

The CSV file first row represents the header which describes the recorded data.

```
"Event";"Device";"L1(2)";"L2(3)";"L3(1)";"Type";"Start [dd/mm/yyyy hh:mm:ss,cc]";"Duration [hh:mm:ss,cc]";
"Un [(k)V]";"Residual/Max [(k)V]";"Residual/Max [%Un]"
```

"Event"	Progressive event number in the current file
"Device"	Instrument name (ID)
"L1(2)";"L2(3)";"L3(1)"	Phases/lines involved in the event
"Type"	Event type. Sag=sag, Swell=swell, Interr.=interruption, Trans=transient
"Start [dd/mm/yyyy hh:mm:ss,cc]"	Starting event date and time with 10 ms accuracy (dd/mm/yyyy hh:mm:ss,cc)
"Duration [hh:mm:ss,cc]"	Event duration with 10 ms accuracy (hh:mm:ss,cc) In case of transient, this value is expressed in micro seconds (µs).
"Un [(k)V]"	Nominal voltage value (V or kV, according to the set PT)
"Residual/Max [(k)V]"	Extreme voltage value detected during the event (V or kV, according to the set PT): <ul style="list-style-type: none"> • Residual in case of voltage sag or interruption • Maximum in case of voltage swell • Voltage difference between the highest sample value during the transient event and the last sample value before the event
"Residual/Max [%Un]"	Extreme voltage value expressed as percentage of the nominal value: <ul style="list-style-type: none"> • Residual in case of voltage sag or interruptions • Maximum in case of voltage swell • Voltage difference between the highest sample value during the transient event and the last sample value before the event

CSV file example:

```
"1";"P-001";"X";"X";"";"Sag";"13/06/2012 07:20:14,13";"00:00:00,13";"15.0";"11.9";"79.33";
"2";"P-001";"X";"";"X";"Swell";"13/06/2012 07:20:18,13";"00:00:01,50";"15.0";"16.1";"107.3"
```

"1"	First event in the current file
"P-001"	Instrument name (ID)
"X";"X";""	Phase 1 and 2 involved in the event, phase 3 not involved
"Sag"	Sag event type
"13/06/2012 07:20:14,13"	The event started on 13th June 2012 at 07:20:14,13
"00:00:00,13"	The event lasted 0.13 s (130 ms)
"15.0"	15 kV set nominal voltage
"11.9"	11.9 kV residual voltage detected during the event
"79.33"	79.33%, residual percentage value, detected during the event, calculated according to nominal voltage

PQDIF file content for fast voltage events

The PQDIF file contains the stored raw data, i.e. the RMS values calculated on ½ wave and the 64 samples/ wave recorded during the sag/swell/interruption event. The PQDIF file can also contain the measured current channels if previously enabled (refer to section 8.7.1). In case of transient event the PQDIF file contains only samples/wave recorded during the event. For each event, the quantity of recorded waves and RMS values depends on the following settings:

- Waves number to be captured at event entry, before threshold exceeding.
- Waves number to be captured at event entry, after threshold exceeding.
- Waves number to be captured at event exit, just before variation ending.
- Waves number to be captured at event exit, after variation ending.

These settings are common for all raw data recordings (fast voltage, frequency, current, U4 voltage events).

The PQDIF files contain the previously described raw data and also the following additional information:

- in a MAGDURTIME tag type, the main event data is stored (extreme value, timestamp, duration)
- dedicated channels contain phases/lines involved in the event
- triggering channel
- current channels (I1, I2, I3) if previously enabled
- in tagTriggerHigh the high threshold percentage value
- in tagTriggerLow the low threshold percentage value
- in tagTriggerLowLow the interruption threshold percentage value

The PQDIF files can be displayed in graphic and table format by any viewer compliant to IEEE P1159.3 specification.

7.9.2. Rapid voltage changes



Note:

- in the rapid voltage changes, only the three phase voltage parameters are involved (U1N, U2N, U3N, U12, U23, U31), according to the wiring mode. The 4th voltage (U4) is not considered.
- according to the set wiring mode, the monitored and recorded parameters change as follows: in 3.4.3 and 1Ph phase-neutral parameters monitored/recorded; in 3.3.3 and 3.3.2 line-line parameters monitored/recorded.
- if rapid voltage change exceeds the fast voltage event thresholds (sags/swells), the rapid voltage event is not recorded.

A rapid voltage change is a quick transition in RMS voltage occurring between 2 steady state conditions, and during which the RMS voltage does not exceed the deep/swell thresholds.

An RMS voltage is in a steady state condition if all the last 100/120 1/2c RMS values detected at a 1/2 wave rate remain within an RVC threshold from the arithmetic mean of those values.

The RVC threshold can be set as a percentage of the nominal voltage. The RVC hysteresis is set as percentage of the RVC threshold.

The RVC event begins when at least one of the phases/lines exits from steady state condition. The RVC hysteresis is applied to the RVC threshold only during the event.

The RVC event ends when all the phases/lines come back to steady state condition. In steady state condition the RVC hysteresis is not considered.

For more details refer to the IEC/EN 61000-4-30:2015 Ed.3 standard.

The main data of all events is stored in a CSV file. If the functional parameters change (i.e. parameters which modify the measurement format, e.g. wiring mode, CT, FSA, ...), a new CSV file is generated automatically.

CSV file content for rapid voltage changes

The CSV file first row represents the header which describes the recorded data.

"Event";"Device";"L1 (2)";"L2 (3)";"L3 (1)";"Start [dd/mm/yyyy hh:mm:ss,cc]";"Duration [h:mm:ss,fff]";"dUmax [(k)V]";"dUss [(k)V]";	
"Event"	Progressive event number in the current file
"Device"	Instrument name (ID)
"L1 (2)";"L2 (3)";"L3 (1)"	Phases/lines involved in the event
"Start [dd/mm/yyyy hh:mm:ss,cc]"	Starting event date and time with 10 ms accuracy (dd/mm/yyyy hh:mm:ss,cc)
"Duration [h:mm:ss,fff]"	Event duration with 1 ms accuracy (h:mm:ss,fff)
"dUmax [(k)V]"	Maximum absolute difference between any of the values during the event and the final steady state value (V or kV, according to the set PT)
"dUss [(k)V]"	Absolute difference between the mean voltage of the first steady state after the event and the mean voltage of the steady state just prior to the event (V or kV, according to the set PT)

CSV file example:

"1";"P-001";"X";"X";"";"13/06/2012 07:20:00,00";"7:20:00,564";"4.36";"0.84"; "2";"P-001";"X";"";"X";"13/06/2012 08:40:00,00";"8:40:00,783";"3.15";"2.26"	
"1"	First event in the current file
"P-001"	Instrument name (ID)
"X";"X";""	Phase 1 and 2 involved in the event, phase 3 not involved
"13/06/2012 07:20:00,00"	The event started on 13th June 2012 at 07:20:00,00
"07:20:00,564"	The event lasted 564 ms
"4.36"	4.36 kV ΔUmax
"0.84"	0.84 kV ΔUss

7.9.3. Frequency fast events

According to the setup, the frequency fast events can be triggered by:

- **high or low frequency detection** - the system compares the values with 2 thresholds, high and low. These thresholds can be programmed and enabled independently from each other.
- **manual trigger** - fast frequency event is triggered by pressing the dedicated button on Web server. This function is active if low frequency threshold was previously enabled

The main data of all events is stored in a CSV file. If the functional parameters change (i.e. parameters which modify the measurement format, e.g. wiring mode, CT, FSA, ...), a new CSV file is generated automatically. For each detected event, raw data (RMS value trend and voltage waveform) is recorded in a PQDIF file. If the functional parameters change, a new PQDIF file is generated automatically.

CSV file content for fast frequency events

The CSV file first row represents the header which describes the recorded data.

```
"Event";"Device";"Type";"Start [dd/mm/yyyy hh:mm:ss,cc]";"Duration [hh:mm:ss,cc]";"Extreme Value min/max[Hz]";
```

"Event"	Progressive event number in the current file
"Device"	Instrument name (ID)
"Type"	Event type. Low=low frequency, High=high frequency, Man=manual trigger, DigIn=DI10 status change
"Start [dd/mm/yyyy hh:mm:ss,cc]"	Starting event date and time with 10 ms accuracy (dd/mm/yyyy hh:mm:ss,cc)
"Duration [hh:mm:ss,cc]"	Event duration with 10 ms accuracy (hh:mm:ss,cc)
"Extreme Value min/max [Hz]"	Extreme frequency value detected during the event (Hz): <ul style="list-style-type: none"> • Minimum in case of low frequency • Maximum in case of high frequency

CSV file example:

```
"1";"P-001";"Low";"13/06/2012 07:20:14,13";"00:00:00,13";"49.500";  
"2";"P-001";"High";"13/06/2012 07:20:18,13";"00:00:01,50";"50.300"
```

"1"	First event in the current file
"P-001"	Instrument name (ID)
"Sag"	Low frequency event
"13/06/2012 07:20:14,13"	The event started on 13th June 2012 at 07:20:14,13
"00:00:00,13"	The event lasted 0.13 s (130 ms)
"49.500"	49.5 Hz residual frequency detected during the event

PQDIF file content for fast frequency events

The PQDIF file contains the stored raw data, i.e. the RMS values calculated on 1/2 wave and the 64 samples/wave recorded during the event. For each event, the quantity of recorded waves and RMS values depends on the following settings:

- Waves number to be captured at event entry, before threshold exceeding.
- Waves number to be captured at event entry, after threshold exceeding.
- Waves number to be captured at event exit, just before variation ending.
- Waves number to be captured at event exit, after variation ending.

These settings are common for all raw data recordings (fast voltage, frequency, current, U4 voltage events).

The fast frequency event PQDIF files contain the previously described raw data and also the following additional information:

- in a MAGDURTIME tag type, the main event data is stored (extreme value, timestamp, duration)
- dedicated channels contain phases/lines involved in the event
- triggering channel
- in tagTriggerHigh the high threshold percentage value
- in tagTriggerLow the low threshold percentage value
- in tagChanTriggerTypeID the event factor (1=low frequency, 3=high frequency, 24=manual trigger)

The PQDIF files can be displayed in graphic and table format by any viewer compliant to IEEE P1159.3 specification.

7.9.4. Fast U4 voltage events



WARNING! Wrong recording settings can generate files with a big amount of unnecessary data, filling up the memory space. Threshold values and number of cycles to be recorded must be set with proper values according to the monitoring application.

The fast U4 voltage events are sudden sags or swells of 4th voltage. The U4 voltage is monitored calculating the RMS at a ½ wave rate (10 ms @50 Hz).

The system compares the values with 2 thresholds, for sags and swells. These thresholds can be programmed and enabled independently from other type of triggers. The event recording starts when the U4 voltage exceeds one of the thresholds.

The main data of all events is stored in a CSV file. If the functional parameters change (i.e. parameters which modify the measurement format, e.g. wiring mode, CT, FSA, ...), a new CSV file is generated automatically. For each detected event, raw data (RMS value trend and voltage waveform) is recorded in a PQDIF file. If the functional parameters change, a new PQDIF file is generated automatically.

CSV file content for fast U4 voltage events

The CSV file first row represents the header which describes the recorded data.

<pre>"Event";"Device";"Type";"Start [dd/mm/yyyy hh:mm:ss,cc]";"Duration [hh:mm:ss,cc]"; "Un [(k)V]";"Residual/Max [(k)V]";"Residual/Max [%Un]";</pre>	
"Event"	Progressive event number in the current file
"Device"	Instrument name (ID)
"Type"	Event type. Sag=sag, Swell=swell
"Start [dd/mm/yyyy hh:mm:ss,cc]"	Starting event date and time with 10 ms accuracy (dd/mm/yyyy hh:mm:ss,cc)
"Duration [hh:mm:ss,cc]"	Event duration with 10 ms accuracy (hh:mm:ss,cc)
"Un [(k)V]"	Nominal U4 voltage value (V or kV, according to the set PT)
"Residual/Max [(k)V]"	Extreme 4th voltage value detected during the event (V or kV, according to the set PT): <ul style="list-style-type: none"> • Residual in case of U4 voltage sag • Maximum in case of U4 voltage swell
"Residual/Max [%Un]"	Extreme 4th voltage value expressed as percentage of the nominal value: <ul style="list-style-type: none"> • Residual in case of U4 voltage sag • Maximum in case of U4 voltage swell

CSV file example:

<pre>"1";"P-001";"Sag";"13/06/2012 07:20:14,13";"00:00:00,13";"100.00";"82.85";"79.33"; "2";"P-001";"Swell";"13/06/2012 07:20:18,13";"00:00:01,50";"100.0";"121.64";"121.64"</pre>	
"1"	First event in the current file
"P-001"	Instrument name (ID)
"Sag"	Sag event type
"13/06/2012 07:20:14,13"	The event started on 13th June 2012 at 07:20:14,13
"00:00:00,13"	The event lasted 0.13 s (130 ms)
"100.0"	100 V set nominal U4 voltage
"11.9"	11.9 kV residual U4 voltage detected during the event
"79.33"	79.33%, residual percentage U4 value, detected during the event, calculated according to nominal voltage

PQDIF FILE CONTENT FOR FAST U4 VOLTAGE EVENTS

The PQDIF file contains the stored raw data, i.e. the RMS values $\frac{1}{2}$ wave calculated and the 64 samples/wave recorded during the event. For each event, the number of recorded waves and RMS values depends on the following settings:

- Waves number to be captured at event entry, before threshold exceeding.
- Waves number to be captured at event entry, after threshold exceeding.
- Waves number to be captured at event exit, just before variation ending.
- Waves number to be captured at event exit, after variation ending.

These settings are common for all raw data recordings (fast voltage, frequency, current, U4 voltage events).

The fast U4 voltage event PQDIF files contain the previously described raw data and also the following additional information:

- in a MAGDURTIME tag type, the main event data is stored (extreme value, timestamp, duration)
- triggering channel
- in tagTriggerHigh the high threshold percentage value
- in tagTriggerLow the low threshold percentage value

The PQDIF files can be displayed in graphic and table format by any viewer compliant to IEEE P1159.3 specification.

7.9.5. Fast current events



WARNING! Wrong recording settings can generate files with a big amount of unnecessary data, filling up the memory space. Threshold values and number of cycles to be recorded must be set with proper values according to the monitoring application.



Note: in the fast current events, only the three phase voltage parameters are involved (I1, I2, I3), according to the wiring mode. The line 4 and 5 currents (I4, I5) are not considered.

The fast current events are current peak detections.

The currents are monitored by calculating the RMS at a $\frac{1}{2}$ wave rate (10 ms @50 Hz).

The system compares the values with a single high threshold which can be programmed and enabled independently from other type of triggers. The event recording starts when at least one of the phases exceeds the threshold.

The main data of all events is stored in a CSV file. If the functional parameters change (i.e. parameters which modify the measurement format, e.g. wiring mode, CT, FSA, ...), a new CSV file is generated automatically. For each detected event, raw data (RMS value trend and voltage waveform) is recorded in a PQDIF file. If the functional parameters change, a new PQDIF file is generated automatically.

CSV file content for fast current events

The CSV file first row represents the header which describes the recorded data.

<code>"Event";"Device";"L1";"L2";"L3";"Start [dd/mm/yyyy hh:mm:ss,cc]";"Duration [hh:mm:ss,cc]";"Max Current [(k)A]";</code>	
<code>"Event"</code>	Progressive event number in the current file
<code>"Device"</code>	Instrument name (ID)
<code>"L1";"L2";"L3"</code>	Phases involved in the event
<code>"Start [dd/mm/yyyy hh:mm:ss,cc]"</code>	Starting event date and time with 10 ms accuracy (dd/mm/yyyy hh:mm:ss,cc)
<code>"Duration [hh:mm:ss,cc]"</code>	Event duration with 10 ms accuracy (hh:mm:ss,cc)
<code>"Max Current [(k)A]"</code>	Max current value detected during the event (A or ka, according to the set FS)

CSV file example:

```
"1";"P-001";"X";"X";"";"13/06/2012 07:20:14,13";"00:00:00,13";"80.8";;  
"2";"P-001";"X";"";"X";"13/06/2012 07:20:18,13";"00:00:01,50";"82.1"
```

"1"	First event in the current file
"P-001"	Instrument name (ID)
"X";"X";""	Phase 1 and 2 involved in the event, phase 3 not involved
"Sag"	Sag event type
"13/06/2012 07:20:14,13"	The event started on 13th June 2012 at 07:20:14,13
"00:00:00,13"	The event lasted 0.13 s (130 ms)
"80.8"	80.8 kA peak current detected during the event

PQDIF FILE CONTENT FOR FAST CURRENT EVENTS

The PQDIF file contains the stored raw data, i.e. the RMS values calculated on ½ wave and the 64 samples/wave recorded during the event. For each event, the quantity of recorded waves and RMS values depends on the following settings:

- Waves number to be captured at event entry, before threshold exceeding.
- Waves number to be captured at event entry, after threshold exceeding.
- Waves number to be captured at event exit, just before variation ending.
- Waves number to be captured at event exit, after variation ending.

These settings are common for all raw data recordings (fast voltage, frequency, current, U4 voltage events).

The fast current event PQDIF files contain the previously described raw data and also the following additional information:

- in a MAGDURTIME tag type, the main event data is stored (extreme value, timestamp, duration)
- dedicated channels contain phases involved in the event
- triggering channel
- in tagTriggerHigh the high threshold percentage value

The PQDIF files can be displayed in graphic and table format by any viewer compliant to IEEE P1159.3 specific.

7.9.6. Slow voltage events



Note:

- in the slow voltage events, only the three phase voltage parameters are involved (U1N, U2N, U3N, U12, U23, U31), according to the wiring mode. The 4th voltage (U4) is not considered.
- according to the set wiring mode, the monitored and recorded parameters change as follows: in 3.4.3 and 1Ph phase-neutral parameters monitored/recorded; in 3.3.3 and 3.3.2 line-line parameters monitored/recorded.
- the integration period is fixed to 1 minute in case of direct connection, with PT ratio set to 1/1 (LV system). In case of MV and HV systems, with the use of PTs and a correct ratio setup, the integration period is fixed to 10 minutes (for further details refer to EN 50160:2011 and EN 50160/A1:2015-01).

The slow voltage events are extreme measurements of phase-neutral or line voltage, according to the set wiring mode.

The system compares the voltage values with 2 thresholds, high and low. These thresholds can be programmed and enabled independently from other type of triggers. The event recording starts when at least one of the phases/lines exceeds the threshold for more than the integration period.

The main data of all events is stored in a CSV file. If the functional parameters change (i.e. parameters which modify the measurement format, e.g. wiring mode, CT, FSA, ...), a new CSV file will be created automatically.

The CSV file first row represents the header which describes the recorded data.

```
"Event";"Device";"L1(2)";"L2(3)";"L3(1)";"Type";"Start [dd/mm/yyyy hh:mm:ss,cc]";"Duration [hh:mm:ss,cc]";
"Un [(k)V]";"Residual/Max [(k)V]";"Residual/Max [%Un]";
```

"Event"	Progressive event number in the current file
"Device"	Instrument name (ID)
"L1(2)";"L2(3)";"L3(1)"	Phases/lines involved in the event
"Type"	Event type. Low=low voltage, High=high voltage
"Start [dd/mm/yyyy hh:mm:ss,cc]"	Starting event date and time with 10 ms accuracy (dd/mm/yyyy hh:mm:ss,cc)
"Duration [hh:mm:ss,cc]"	Event duration with 10 ms accuracy (hh:mm:ss,cc)
"Un [(k)V]"	Nominal voltage value (V or kV, according to the set PT)
"Residual/Max [(k)V]"	Extreme voltage value detected during the event (V or kV, according to the set PT): <ul style="list-style-type: none"> • Residual in case of low voltage • Maximum in case of high voltage
"Residual/Max [%Un]"	Extreme voltage value expressed as percentage of the nominal value: <ul style="list-style-type: none"> • Residual in case of low voltage • Maximum in case of high voltage

CSV file example:

```
"1";"P-001";"X";"X";"";"Low";"13/06/2012 07:20:00,00";"00:03:00,00";"15.0";"11.9";"79.33";
"2";"P-001";"X";"";"X";"High";"13/06/2012 07:45:00,00";"00:05:00,00";"15.0";"16.1";"107.3"
```

"1"	First event in the current file
"P-001"	Instrument name (ID)
"X";"X";""	Phase 1 and 2 involved in the event, phase 3 not involved
"Low"	Low voltage event
"13/06/2012 07:20:00,00"	The event started on 13th June 2012 at 07:20:00,00
"00:03:00,00"	The event lasted 3 minutes
"15.0"	15 kV set nominal voltage
"11.9"	11.9 kV residual voltage detected during the event
"79.33"	79.33%, residual percentage value, detected during the event, calculated according to nominal voltage

7.9.7. Slow frequency events



Note: for data monitoring in compliance with EN 50160 standard, set the integration time to 10 s.

The slow frequency events are high or low frequency detections.

The system compares the frequency values with 2 thresholds, high and low. These thresholds can be programmed and enabled independently from other type of triggers. The event recording starts when the frequency value exceeds the threshold.

The main data of all events is stored in a CSV file. If the functional parameters change (i.e. parameters which modify the measurement format, e.g. wiring mode, CT, FSA, ...), a new CSV file is generated automatically.

CSV file content for slow frequency events

The CSV file first row represents the header which describes the recorded data.

"Event";"Device";"Type";"Start [dd/mm/yyyy hh:mm:ss,cc]";"Duration [hh:mm:ss,cc]";"Extreme Value min/max[Hz]";	
"Event"	Progressive event number in the current file
"Device"	Instrument name (ID)
"Type"	Event type. Low=low frequency, High=high frequency
"Start [dd/mm/yyyy hh:mm:ss,cc]"	Starting event date and time with 10 ms accuracy (dd/mm/yyyy hh:mm:ss,cc)
"Duration [hh:mm:ss,cc]"	Event duration with 10 ms accuracy (hh:mm:ss,cc)
"Extreme Value min/max [Hz]"	Extreme frequency value detected during the event (Hz): <ul style="list-style-type: none"> • Minimum in case of low frequency • Maximum in case of high frequency

CSV file example:

"1";"P-001";"Low";"13/06/2012 07:20:00,00";"00:00:10,00";"49.500"; "2";"P-001";"High";"13/06/2012 07:40:00,00";"00:00:30,00";"50.300"	
"1"	First event in the current file
"P-001"	Instrument name (ID)
"Low"	Low frequency event
"13/06/2012 07:20:00,00"	The event started on 13th June 2012 at 07:20:00,00
"00:10:00,00"	The event lasted 10 minutes
"49.500"	49.5 Hz residual frequency detected during the event

7.9.8. Slow flicker events



Note:

according to the set wiring mode, the monitored and recorded parameters change as follows: in 3.4.3 and 1Ph phase-neutral parameters monitored/recorded; in 3.3.3 and 3.3.2 line-line parameters monitored/recorded.

The slow long term flicker events are Plt high values detections.

The Plt values are calculated every 2 even hours. The system compares the values with a single high threshold which can be programmed and enabled independently from other type of triggers. The event recording starts when at least one of the phases exceeds the threshold. For more details refer to the EN 50160 standard.

The main data of all events is stored in a CSV file. If the functional parameters change (i.e. parameters which modify the measurement format, e.g. wiring mode, CT, FSA, ...), a new CSV file is generated automatically.

CSV file content for slow flicker events

The CSV file first row represents the header which describes the recorded data.

"Event";"Device";"L1(2)";"L2(3)";"L3(1)";"Start [dd/mm/yyyy hh:mm:ss,cc]";"Duration [hh:mm:ss,cc]";"Plt max";	
"Event"	Progressive event number in the current file
"Device"	Instrument name (ID)
"L1(2)";"L2(3)";"L3(1)"	Phases/lines involved in the event
"Start [dd/mm/yyyy hh:mm:ss,cc]"	Starting event date and time with 10 ms accuracy (dd/mm/yyyy hh:mm:ss,cc)
"Duration [hh:mm:ss,cc]"	Event duration with 10 ms accuracy (hh:mm:ss,cc)
"Plt max"	Maximum Plt value detected during the event

CSV file example:

"1";"P-001";"X";"X";"";"13/06/2012 06:00:00,00";"02:00:00,00";"1.3";	
"2";"P-001";"X";"";"X";"13/06/2012 08:00:00,00";"02:00:00,00";"1.1"	
"1"	First event in the current file
"P-001"	Instrument name (ID)
"X";"X";""	Phase 1 and 2 involved in the event, phase 3 not involved
"Sag"	Sag event type
"13/06/2012 06:00:00,00"	The event started on 13th June 2012 at 06:00:00,00
"02:00:00,00"	The event lasted 2 hours
"1.3"	1.3 max Plt value detected during the event

7.9.9. Slow voltage THD events



Note:

according to the set wiring mode, the monitored and recorded parameters change as follows: in 3.4.3 and 1Ph phase-neutral parameters monitored/recorded; in 3.3.3 and 3.3.2 line-line parameters monitored/recorded.

The slow voltage THD events are high voltage THD detections.

The voltage THD is calculated every 10 minutes. The system compares the values with a single high threshold which can be programmed and enabled independently from other type of triggers. The event recording starts when at least one of the phases/lines exceeds the threshold. For more details refer to the EN 50160 standard.

The main data of all events is stored in a CSV file. If the functional parameters change (i.e. parameters which modify the measurement format, e.g. wiring mode, CT, FSA, ...), a new CSV file is generated automatically.

CSV file content for slow voltage THD events

The CSV file first row represents the header which describes the recorded data.

"Event";"Device";"L1(2)";"L2(3)";"L3(1)";"Start [dd/mm/yyyy hh:mm:ss,cc]";"Duration [hh:mm:ss,cc]";"Max Value[%]";	
"Event"	Progressive event number in the current file
"Device"	Instrument name (ID)
"L1(2)";"L2(3)";"L3(1)"	Phases/lines involved in the event
"Start [dd/mm/yyyy hh:mm:ss,cc]"	Starting event date and time with 10 ms accuracy (dd/mm/yyyy hh:mm:ss,cc)
"Duration [hh:mm:ss,cc]"	Event duration with 10 ms accuracy (hh:mm:ss,cc)
"Max Value [%]"	Maximum voltage THD value detected during the event (%)

CSV file example:

"1";"P-001";"X";"X";"";"13/06/2012 07:20:00,00";"00:10:00,00";"8.20"; "2";"P-001";"X";"";"X";"13/06/2012 07:40:00,00";"00:10:00,00";"8.10"	
"1"	First event in the current file
"P-001"	Instrument name (ID)
"X";"X";""	Phase 1 and 2 involved in the event, phase 3 not involved
"13/06/2012 07:20:00,00"	The event started on 13th June 2012 at 07:20:00,00
"00:10:00,00"	The event lasted 10 minutes
"8.20"	8.20% max THD voltage detected during the event

7.9.10. Slow unbalance events



Note: the u_2 unbalance events are generated if the set wiring mode is in three phase system (e.g. 3.4.3, 3.3.3, 3.3.2). The u_0 unbalance events are generated if the three phase 4 wire 3 current wiring mode (3.4.3) is set.

The slow unbalance events are high u_2 and/or u_0 unbalance ratio detections.

The u_2 and u_0 unbalance ratios are calculated every 10 minutes.

The system compares the values with 2 thresholds, according to the unbalance parameter (u_2 and/or u_0). These thresholds can be programmed and enabled independently from other type of triggers. The event recording starts when at least one of the unbalance parameters (u_2 and/or u_0) is out of threshold. For more details refer to the EN 50160 standard.

The main data of all events is stored in a CSV file. If the functional parameters change (i.e. parameters which modify the measurement format, e.g. wiring mode, CT, FSA, ...), a new CSV file is generated automatically.

CSV file content for slow unbalance events

The CSV file first row represents the header which describes the recorded data.

"Event";"Device";"Type";"Start [dd/mm/yyyy hh:mm:ss,cc]";"Duration [hh:mm:ss,cc]";"Max Value";	
"Event"	Progressive event number in the current file
"Device"	Instrument name (ID)
"Type"	Parameter which triggered the event. u_2 =negative sequence ratio, u_0 =zero sequence ratio
"Start [dd/mm/yyyy hh:mm:ss,cc]"	Starting event date and time with 10 ms accuracy (dd/mm/yyyy hh:mm:ss,cc)
"Duration [hh:mm:ss,cc]"	Event duration with 10 ms accuracy (hh:mm:ss,cc)
"Max Value"	Max value of the triggering parameter, detected during the event

CSV file example:

"1";"P-001";"u2";"13/06/2012 07:20:00,00";"00:10:00,00";"3.100";	
"2";"P-001";"u0";"13/06/2012 07:40:00,00";"00:10:00,00";"3.200"	
"1"	First event in the current file
"P-001"	Instrument name (ID)
"X";"X";""	Phase 1 and 2 involved in the event, phase 3 not involved
"u2"	The event was triggered by u_2 parameter
"13/06/2012 07:20:00,00"	The event started on 13th June 2012 at 07:20:00,00
"00:10:00,00"	The event lasted 10 minutes
"3.100"	3.1% u_2 parameter detected during the event

7.9.11. Mains Signalling events

The Mains Signalling events are detections of high Mains Signalling voltage on the supply voltage.

The Mains Signalling values on all 5 set components are monitored as mean value on 3 s and compared with threshold limits defined in Figure 1. The event recording starts when at least one Mains Signalling component exceeds the values given in Figure 1. For more details refer to the EN 50160 standard.

The main data of all events is stored in a CSV file. If the functional parameters change (i.e. parameters which modify the measurement format, e.g. wiring mode, CT, FSA, ...), a new CSV file is generated automatically.

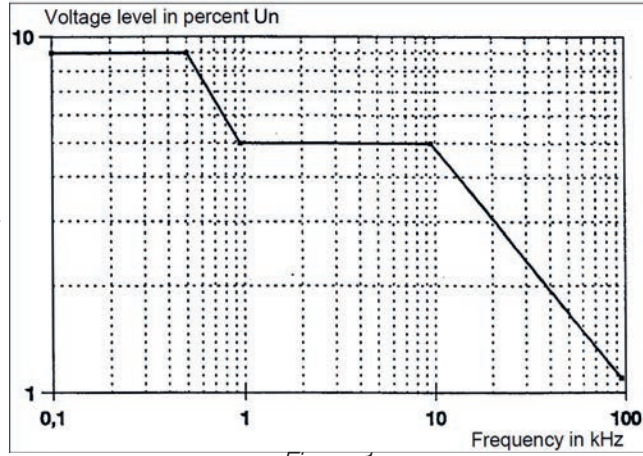

Figure 1

CSV file content for Mains Signalling events

The CSV file first row represents the header which describes the recorded data.

"Event";"Device";"Phase/Line";"MS";"Start [dd/mm/yyyy hh:mm:ss]";"Duration [hh:mm:ss]";"Un [(k)V]";"Max [(k)V]";"Max [%Un]";	
"Event"	Progressive event number in the current file
"Device"	Instrument name (ID)
"Phase/Line"	Phase/line involved in the event
"MS Index"	Index of Mains Signalling involved in the event
"Start [dd/mm/yyyy hh:mm:ss]"	Starting event date and time with 1 s accuracy (dd/mm/yyyy hh:mm:ss)
"Duration [hh:mm:ss]"	Event duration with 1 s accuracy (hh:mm:ss)
"Un [(k)V]"	Nominal voltage value (V or kV, according to the set PT)
"Max [(k)V]"	Max Mains Signalling voltage detected during the event (V or kV, according to the set PT)
"Max [%Un]"	Max Mains Signalling voltage expressed as percentage of nominal voltage

CSV file example:

```
"1";"P-001";"1";"2";"13/06/2012 07:20:00";"00:00:09";"230.00";"12.55";"5.45";
"2";"P-001";"1";"2";"13/06/2012 07:44:03";"00:00:12";"230.00";"11.01";"4.78"
```

"1"	First event in the current file
"P-001"	Instrument name (ID)
"1"	Phase 1 involved in the event
"2"	Mains Signalling 2 involved in the event
"13/06/2012 07:20:00,00"	The event started on 13th June 2012 at 07:20:00,00
"00:00:09"	The event lasted 9 seconds
"230.00"	230 V set nominal voltage
"12.55"	12.55 V max Mains Signalling voltage detected during the event
"5.45"	5.45%, max Mains Signalling voltage percentage, detected during the event, calculated according to nominal voltage

7.9.12. Generated event file name

The event files (CSV, PQDIF) are automatically generated with a specific name, corresponding to the instrument and event type.

CSV file example (fast voltage event): **B01A000001_evFastVolt_201301101030.csv**

B01A000001	Serial number of the instrument which recorded the event.
evFastVolt	Event type.
20130110103001	Date and time of file opening (yyyymmddhhmm).

The following table shows all file names according to event.

EVENT TYPE	CSV FILE NAME	PQDIF FILE NAME
Fast voltage	·SN·_evFastVolt_yyyymmddhhmm.csv	·SN·_evFastVolt_yyyymmddhhmm.pqd
Rapid voltage change	·SN·_evRVC_yyyymmddhhmm.csv	-
Fast frequency	·SN·_evFastFreq_yyyymmddhhmm.csv	·SN·_evFastFreq_yyyymmddhhmm.pqd
U4 voltage	·SN·_evVolt4_yyyymmddhhmm.csv	·SN·_evVolt4_yyyymmddhhmm.pqd
Current	·SN·_evFastCurr_yyyymmddhhmm.csv	·SN·_evFastCurr_yyyymmddhhmm.pqd
Slow voltage	·SN·_evSlowVolt_yyyymmddhhmm.csv	-
Slow frequency	·SN·_evSlowFreq_yyyymmddhhmm.csv	-
Flicker	·SN·_evFlicker_yyyymmddhhmm.csv	-
Voltage THD	·SN·_evVoltTHD_yyyymmddhhmm.csv	-
Voltage unbalance	·SN·_evUnbal_yyyymmddhhmm.csv	-
Mains Signalling	·SN·_evMS_yyyymmddhhmm.csv	-

A TAR file contains all available PQDIF and CSV files of the same recording type. It is automatically generated and downloaded by clicking on the **Download All** button (refer to section “8.1. Web server structure”, page 54).

7.10. Digital input LOG

If at least one channel is enabled, the instrument starts to monitor the status of all digital inputs.

When a status change occurs, all channel status are automatically stored in the inputs LOG, a CSV file.

The CSV file content can be displayed, downloaded or deleted by touch screen or Web server.

File name example: **B01A000001_DILog_20130110103001.csv**

B01A000001	Serial number of the instrument which recorded the event.
DILog	Recording type: digital input LOG.
20130110103001	Date and time of file opening (yyyymmddhhmmss).

CSV file content for Inputs LOG

The CSV file first row represents the header which describes the recorded data.

"Start";"IN1";"IN2";"IN3";"IN4";	
"Start [dd/mm/yyyy hh:mm:ss,cc]"	Date and time at status change (dd/mm/yyyy hh:mm:ss,cc)
"IN1" ... "IN4"	Digital input status detected when one or more input status changes. A=high, B=low, N/A=not available, the input is disabled

CSV file example:

"23/09/2013";"20:05:00";"A";"A";"B";"A";	
"23/09/2013";"22:10:00";"A";"B";"B";"A";	
"23/09/2013 20:05:00,01"	Status change recorded on 23rd September 2013 at 20:05:00,01
"A"	Digital input 1 was in "high" status during digital input status change

7.11. Logging

The instrument can store in LOG files the Min/Avg/Max values and the energy counters, according to the setup. A LOG type recording is a specific data recording at fixed time rate. The functional LOG, which stores activity information relevant to the instrument operation (power on, etc.), is automatically stored with no need to program it.

7.11.1. Min/Avg/Max LOG

The instrument can record Min/Avg/Max values for the programmed parameters at a preset rate.

Enable the measurement parameters and set the recording rate, the instrument will start to record the Min/Avg/Max values in a PQDIF file. When an event occurs during recording, the corresponding record is flagged in the PQDIF file to indicate possible values corrupted due to the event.

If the recording setup or the wiring mode changes during Min/Avg/Max value recording, a new file is created automatically.

All recorded files can be displayed, downloaded or deleted by touch screen or Web server.

File name example: **B01A000001_mAMLog_20130110103001.pqd**

B01A000001	Serial number of the instrument which performed the recording.
mAMLog	Recording type: Min/Avg/Max data LOG.
20130110103001	Date and time of file opening (yyyymmddhhmmss).

The PQDIF file is a standard format, refer to the IEEE P1159.3 specification. Some parameters may not be available according to the set wiring mode (refer to the parameter table in section "7.3. Measurement monitoring", page 24).

7.11.2. Demand LOG

The instrument can record demand values for the selected demand parameters, according to the set calculation mode. Data will be recorded in a CSV file at the realtime demand calculation rate, according to the set period and mode.

If the Demand mode, Demand period, Demand Subperiod or wiring mode changes during Demand value recording, a new file is created automatically. A list of recorded files can be displayed, downloaded or deleted all together or individually by touch screen or Web server.

File name example: **B01A000001_DMD_20130110103000.csv**

B01A000001	Serial number of the instrument which performed the recording.
DMD	Recording type: Demand LOG.
20130110103000	Date and time of file opening (yyyymmddhhmmss).

CSV file content for Demand LOG

```
"Index";"Date [dd/mm/yyyy]";"Hour [hh:mm:ss]";" I1DMD";" I2DMD";" I3DMD";" IsysDMD";" I4DMD";" I5DMD";" +P1DMD";" -P1DMD";" +P2DMD";" -P2DMD";" +P3DMD";" -P3DMD";" +PsysDMD";" -PsysDMD";" +Q1DMD";" -Q1DMD";" +Q2DMD";" -Q2DMD";" +Q3DMD";" -Q3DMD";" +QsysDMD";" -QsysDMD";" +S1DMD";" -S1DMD";" +S2DMD";" -S2DMD";" +S3DMD";" -S3DMD";" +SsysDMD";" -SsysDMD";" +TPF1DMD";" -TPF1DMD";" +TPF2DMD";" -TPF2DMD";" +TPF3DMD";" -TPF3DMD";" +TPFsysDMD";" -TPFsysDMD";
```

"Index"	Progressive recording number in the current file
"Date [dd/mm/yyyy]"	Recording date (dd/mm/yyyy)
"Hour [hh:mm:ss]"	Recording time (hh:mm:ss)
"I1DMD" ... "-TPFsysDMD"	Recorded demand value of the corresponding parameter

CSV file example:

```
"1";"18/04/2018";"12:12:00";"2.5223";"2.5232";"2.5231";"2.5229";"2.5255";"2.5217";"124.2690";"273.9660";"123.7890";"274.65 80";"124.9640";"274.2420";"373.0230";"822.8660";"145.9950";"251.8040";"146.8480";"251.4510";"145.4490";"251.7710";"438.2930";"755.0270";"179.2660";"400.4100";"179.4320";"400.8320";"179.2800";"400.6850";"537.9780";"1201.9270";"0.4270";"0.2620";"0.4280";"0.2600";"0.4300";"0.2610";"0.4280";"0.2610";
```

"1"	First recording in the current file
"18/04/2018"	Values recorded on 18th April 2018
"12:12:00"	Values recorded at 12:12:00
"2.5223"	2.5223 A phase 1 current demand recorded in Demand LOG

7.11.3. Frequency LOG

The instrument can record a Frequency LOG at the preset rate.

Set the rate/integration time and enable the Frequency LOG, the instrument will start to record the frequency values in a PQDIF file. When an event occurs during Frequency LOG recording, the corresponding record is flagged in the PQDIF file to indicate possible values corrupted due to the event.

If the integration time setup or the wiring mode changes during Frequency LOG recording, a new file is created automatically. A list of recorded files can be displayed, downloaded or deleted all together or individually by touch screen or Web server.

File name example: **B01A000001_FreqLog_20130110103001.pqd**

B01A000001	Serial number of the instrument which performed the recording.
FreqLog	Recording type: Frequency LOG.
20130110103001	Date and time of file opening (yyyymmddhhmmss).

The PQDIF file is a standard format, refer to the IEEE P1159.3 specification.

7.11.4. Energy counter LOG

After Energy counter LOG enabling and rate programming, the instrument will start to store the energy counters in a CSV file. The recording will start according to the set rate:

- If rate is a submultiple of 60 min > recording will start in a way to remain within an integer hour
e.g. with 4 min rate, Energy counter LOG enabled at 11:02:25 > the recording will start at 11:04:00
- If rate is not a submultiple of 60 min > recording will start at the incoming integer minute
e.g. with 7 min rate, Energy counter LOG enabled at 11:02:25 > the recording will start at 11:03:00
- If rate is 30 min or its multiple > recording will start at the incoming half an hour
e.g. with 30 min rate, Energy counter LOG enabled at 11:02:25 > the recording will start at 11:30:00
- If rate is 60 min or its multiple > recording will start at the incoming integer hour
e.g. with 60 min rate, Energy counter LOG enabled at 11:02:25 > the recording will start at 12:00:00
- If rate is 1440 min (24h) > recording will start at midnight
e.g. with 1440 min rate, Energy counter LOG enabled at 11:02:25 > the recording will start at 00:00:00

The CSV file content can be displayed, downloaded or deleted by touch screen or Web server.

File name example: **B01A000001_EnCount_20130110103001.csv**

B01A000001	Serial number of the instrument which recorded the event.
EnCount	Recording type: energy counter LOG.
20130110103001	Date and time of file opening (yyyymmddhhmmss).

CSV file content for Energy counter LOG

The CSV file first row represents the header which describes the recorded data.

"Index";"Date[dd/mm/yyyy]";"Hour[hh:mm:ss]";"+kWh";"-kWh";"kVAh";"+kvarh-L";"+kvarh-C";"-kvarh-L";"-kvarh-C";	
"Index"	Progressive recording number in the current file
"Date [dd/mm/yyyy]"	Recording date (dd/mm/yyyy)
"Hour [hh:mm:ss]"	Recording time (hh:mm:ss)
" +kWh" ... "-kvarh-C"	Recorded value of the corresponding energy counter expressed in kilo (k)

CSV file example:

"1";"23/09/2013";"20:05:00";"1.17";"0.00";"48.76";"0.06";"0.00";"0.00";"0.02";	
"1"	First event in the current file
"23/09/2013"	Energy counter LOG recorded on 23rd September 2013
"20:05:00"	Energy counter LOG recorded at 20:05:00
"1.17"	First counter recorded in Energy counter LOG, 1.17 kWh imported active energy

7.11.5. Functional LOG

The functional LOG contains all the instrument operation events. It is automatically generated and stored when the following events occurs:

- Instrument start
- Instrument firmware update
- Low battery
- Out of battery, instrument switching off
- no GPS signal
- GPS signal lock
- Setup change
- Data erasing
- FTP uploading

All functional LOG events are stored in a CSV file which can be displayed, downloaded or deleted by touch screen or Web server.

File name example: **B01A000001_FuncLog_201301101030.csv**

B01A000001 Serial number of the instrument which recorded the event.
FuncLog Recording type: functional LOG.
20130110103001 Date and time of file opening (yyyymmddhhmmss).

CSV file content for Functional LOG

The CSV file first row represents the header which describes the recorded data.

"Start";"Event";"Description";"Value";	
"Start"	Starting event date and time (dd/mm/yyyy hh:mm:ss,cc)
"Event"	Instrument part/functionality which triggered the event. System=system status, GPS=GPS signal status, Battery=battery status, Setup=change of settings, Record=erase of recorded files, FTP=automatic FTP uploading
"Description"	Details about the triggered functional event. Update Started=device updating start, Update Completed=device updated with success, Start=device power on, No signal=no GPS signal, Recovered signal=GPS signal fixed, Low=low battery, Low, power off=dead battery (device in switching off), ·parameter·=name of the modified parameter, Manual erase=data erased manually, Automatic erase=data erased automatically, Start=FTP uploading start, Finish=FTP uploading end
"Value"	Field available in case of Setup or Record event. Modified value or name of the erased file

The following table describes functional event examples with the corresponding CSV file.

FUNCTIONAL EVENT	CSV FILE EXAMPLE
Device power on	"10/01/2013 10:30:11,10";"System";"Start";" ";
Device updated with success	"10/01/2013 10:30:11,10";"System";"Update Completed";"Ok";
Low battery	"10/01/2013 10:30:11,10";"Battery";"Low";" ";
Low battery, power off	"10/01/2013 10:30:11,10";"Battery";"Low,power off";" ";
No GPS signal	"10/01/2013 10:30:11,10";"GPS";"No signal";" ";
GPS signal fixed	"10/01/2013 10:30:11,10";"GPS";"Recovered signal";" ";
Setup is changed, RTC synchro is set to GPS	"10/01/2013 10:30:11,10";"Setup";"Sinc.RTC";"GPS";
Files manually erased by Administrator	"10/01/2013 10:30:11,10";"Record";"Manual erase"; "B01A000001_mAMlog_201301101030.pqd";
Files automatically erased after server upload	"10/01/2013 10:30:11,10";"Record";"Automatic erase"; "B01A000001_evFreqVel_201301101030.csv";
Automatic FTP uploading start	"10/01/2013 10:30:11,10";"FTP";"Start"; "TRGEV : B146P60001_evFastFreq_20130717142002.csv"

7.12. Demand Max

The instrument automatically stores the maximum (peak) value of demand of currents, active powers, reactive powers, apparent powers and true power factors, together with timestamp expressed in date and hour when the maximum value was detected. The timestamp is in local time with 1 s resolution. These values are kept till a higher demand was calculated, measurement parameter was changed or the Demand MAX values are reset by the user. In case of instrument restart, reboot the previously saved demand MAX values will be recovered.

Demand MAX values are stored for different time periods: previous month, actual month, previous week, actual week, previous day, actual day.

The Demand MAX values are shown by display, by Web server or can be read by MODBUS protocol.

7.13. Recording transfer

All recordings can be transferred manually or automatically. To transfer recordings manually, use the Web server. For automatic recording upload, a remote FTP/SFTP server connection is performed.

7.13.1. How to upload the recorded data on a remote server

The instrument can perform an automatic connection to an external FTP/SFTP server for recorded data upload. The automatic upload can be performed:

- After a fast frequency event recording (temporary) - ONLY fast frequency files uploading
- If automatic daily uploading was previously set – all file uploading (CSV, PQDIF)
- At 85% used memory - all file uploading (CSV, PQDIF)

To enable the automatic uploading, first set the following parameters:

- The protocol type (FTP or SFTP)
- The FTP/SFTP server address
- The username & password for server access
- The folder name where the uploaded files will be stored (e.g. File-Instr01)



Note: if the set folder is not available on the FTP server, it is created automatically. On the contrary, on the SFTP server it must be created BEFORE carrying out this setup.

In case of SFTP server, first create the destination folder on the SFTP server (e.g. File-Instr01) and then set the automatic upload. At the end, enable the connection channel by inserting the RSA public key on the SFTP server.

Everytime the instrument starts a connection to the external FTP/SFTP server for data uploading, a new folder is created under the preset folder (e.g. File-Strum01). The name of this new folder is structured with the instrument serial number and current date&time: <SN>_<yyyymmddhhmm> (e.g. B01A000001_201301101255). After the folder creation, the following data will be uploaded:

- Fast voltage events (CSV, PQDIF)
- Fast frequency events* (CSV, PQDIF)
- Fast U4 voltage events (CSV, PQDIF)
- Rapid voltage changes (CSV)
- Overcurrent events (CSV, PQDIF)
- Slow voltage events (CSV)
- Slow frequency events (CSV)
- Flicker events (CSV)
- Voltage THD events (CSV)
- Voltage unbalance ratio events (CSV)
- Min/Avg/Max recordings (PQDIF)
- Demand LOG (CSV)
- Frequency LOG (PQDIF)
- Energy counter LOG (CSV)
- Digital inputs LOG (CSV)
- Functional LOG (CSV)

* In case of frequency transient, only the corresponding CSV and PQDIF files are uploaded.

In case of failure of external FTP/SFTP connection or data upload, the instrument retries to connect and upload data every 15 minutes until the operation is succeeded. The last uploading result can be checked on Status page.

7.13.2. Data upload triggered by frequency event

At the end of each fast frequency event, the instrument performs a connection to the external FTP/SFTP server and uploads the relevant PQDIF file.

To have this function operational, make sure that the instrument remote connection is operating, FTP/SFTP parameters are correct and frequency thresholds are set and enabled.



Note: if the automatic delete function is enabled, at the end of data uploading the corresponding recordings will be erased from the instrument memory.

7.13.3. Daily data upload

For each day of the week, it is possible to enable and set time for automatic data uploading from the instrument to FTP/SFTP server. The automatic uploading can start at different time according to daily programming.

To have this function operational, make sure that the instrument remote connection is operating, FTP/SFTP parameters are correct and daily scheduling is programmed.



Note: if the automatic delete function is enabled, at the end of data uploading the corresponding recordings will be erased from the instrument memory.

7.13.4. Data upload triggered by full memory

Every time the memory is filled up at >85%, the instrument performs a connection to the external FTP/SFTP server and uploads all recorded data. At the end of data uploading, the corresponding recordings will be erased from the instrument memory.

To have this function operational, make sure that the instrument remote connection is operating, FTP/SFTP parameters are correct.

7.14. Automatic email for alarms/events

The instrument can send automatic emails to preset email addresses (max. 5 email addresses) if an alarm or event occurs. The instrument can send automatic email in case of:

- functional events
- setup changes
- fast voltage events
- slow frequency events
- digital input status changes
- digital output alarms

These alarms/events can be enabled individually for each email address.

Each email has a different header and content according to the alarm/event type:

EVENT/ALARM	EMAIL HEADER	EMAIL CONTENT
Functional event	Functional event from device - ID: Device01 / SN: B01A000001	Event timestamp Event type Event description
Setup change	Setup was changed on device - ID: Device01 / SN: B01A000001	Setup timestamp Setup change description
Fast voltage event	Fast voltage event was recorded on device - ID: Device01 / SN: B01A000001	Event timestamp Event type Event phases Event duration Event residual value
Slow frequency event	Slow frequency event was recorded on device - ID: Device01 / SN: B01A000001	Event timestamp Event type Event duration Event residual value
Digital input	Digital input status changed on device - ID: Device01 / SN: B01A000001	DI status change timestamp Digital input channel Digital input changed to
Digital output	Digital output status changed on device - ID: Device01 / SN: B01A000001	Digital output alarm timestamp Digital output channel Assigned parameter Threshold value Digital output alarm status

Make sure that an email account has been created for the instrument which will send the alarm email. To set this function, refer to section 8.7.6.

-  Note:
- for proper functioning, check the permissions of email account access to non-standard applications.
 - some email servers may have safety settings not compatible with the automatic email function of the instrument.

7.15. WIFI feature

The instrument is provided with WIFI port, which can be set in access point (AP) or client mode.

In case of **Access Point** mode, the instrument broadcasts a WIFI network with a programmable name. This broadcasted network can be searched and connected by any WIFI client (e.g. a tablet). After connection on the instrument WIFI network, open a common web browser (e.g. Mozilla Firefox, Google Chrome, ...) and enter the WIFI IP address previously set: the instrument Web server will be displayed for data reading or programming.

In case of **Client** mode, the instrument searches for the available WIFI networks and then performs the connection on the selected one. By any WIFI device (e.g. a tablet), open a common web browser (e.g. Mozilla Firefox, Google Chrome, ...) and enter the WIFI IP address previously set: the instrument Web server will be displayed for data reading or programming.

8. WEB SERVER

After instrument connection and switching on, access to Web server for instrument data reading and setup. The Web server graphic interface is the same displayed on the instrument touch screen.

Web server is the instrument web interface which allows to manage the instrument by any PC using a simple web browser.

If LAN network has a different IP class compared to the instrument default IP address, the following procedure is suggested:

1. Change the PC IP class according to the instrument default IP address (192.168.1.254).
2. Access to Web server by typing 192.168.1.254 in the web address field of the Internet browser. Change the instrument IP address and the Netmask according to the IP LAN class.
3. Set again the previous PC IP class.

After IP class verification, access to Web server. The Real Time page will be displayed.



WARNING! If the instrument is managed by an Internet connection, before IP address changing, set the router with a new NAT rule or Port Forwarding relevant to the new address to be set. Otherwise, the instrument remote access will be lost!



Note:

- for a safety Web server use, change the Administrator Password for instrument setup. The default password is "admin".
- after the first access, it is important to change the instrument Web server IP address.

8.1. Web server structure

Note: in Real Time, Harmonics and Graphics sections, the data refresh time is about 1 s.

Web server is structured in different sections:

- **Real Time:** display all the main electrical parameters in realtime. In Custom page, up to 8 parameters can be displayed according to the programming.
- **Harmonics:** display voltage and current harmonics and interharmonics in table or graphic format as well as THD values.
- **Graphics:** it allows to display voltage and current Waveform or Phasors or graphic demand, according to the selection in the menu.
- **Recordings:** it allows to display, download or delete file list about stored events, Min/Avg/Max values, Energy counter LOG, Input LOG, Demand LOG and Functional LOG.
- **Status:** show instrument information and status.
- **Setup:** it allows to display and change instrument settings (General, Thresholds, Min/Avg/Max, Energy counter LOG, Communication, I/O).
- **Administration:** it allows to update, reboot or perform a set default and other features.

These sections can be accessed by clicking on the relevant button on the main menu in the Web server top area:

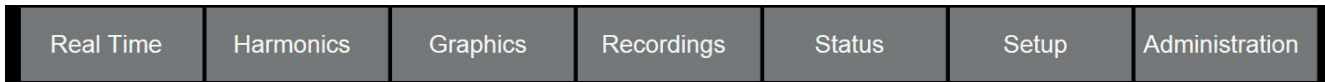



For each section a sub-menu is available under the main menu, providing page selection on the main area. The following example shows **Real Time** sub-menu:



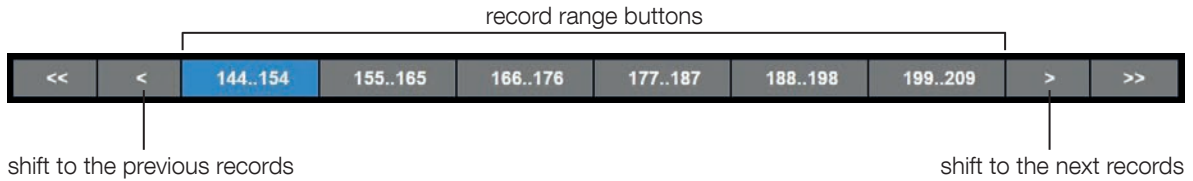

In case of more **Recordings** pages, the following buttons are displayed on the bottom for page selection:



In **Recordings** pages, the following buttons are always displayed in the top left area under the main menu:

-  Download the recorded files of the corresponding **Recordings** page. A pop-up window will be shown to save data on the local PC. A TAR file, containing the CSV and/or PQDIF files, will be downloaded.
-  Delete all stored files of the corresponding **Recordings** page. A confirmation message will be shown. Confirm with **Yes**, a password will be requested. Insert the administrator password and confirm with **Yes**, all data will be erased and will not be retrievable.

In **Setup** pages, the following buttons are always displayed in the top left area under the main menu:

-  Enable the programming mode. A password will be requested, insert the administrator password and confirm with **Yes**, the settings will be available to be changed.
-  Confirm the changes in programming mode. If the operation is successful, the message **Setup was performed correctly** is shown. If the operation is not successful, an error message is shown.
-  Cancel without saving in programming mode.



8.1.1. Control features for graphic view

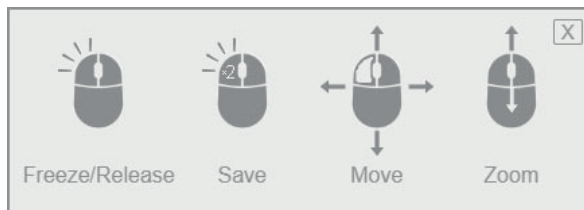

In graphic pages, an info window can be shown by pressing the  button displayed only when the mouse pointer hovers over the graphic. This info window shows the features available for the current graphic.

The info window changes according to the graphic type and it is not available by instrument display. The following example shows the info window in case of **Harmonics** in graphic mode:



The following table shows all the features available (●) for each graphic type.

In Recordings sections, these features are available in Raw data or Waveform preview, by clicking on  or  button.

FEATURES	HARMONICS		GRAPHICS		RECORDINGS  		
	Graphic view	Waveform	Phasor	Demand	PQ Events	U4 Events	Curr. Events
Freeze/Release	●	●	●				
Save	●	●	●	●	●	●	●
Move	●	●		●	●	●	●
Zoom	●	●		●	●	●	●

Freeze/Release Freeze/release the currently displayed graphic, according to the instrument use:

By web server: Place the cursor over the graphic and then press the left mouse button, “Freezed” will be shown on the top of the graphic. Release it by pressing again the left mouse button, “Freezed” will disappear.

By instrument display: One tap on the graphic, “Freezed” will be shown on the top of the graphic. Release it by another one tap, “Freezed” will disappear.

Save **Feature available only by web server.** Save the currently displayed graphic in a PNG file format by double-clicking the left mouse button. A pop-up window will be shown to save data on the local PC.

Move **Feature available only by web server.** Move the graphic in every direction by holding the left mouse button and moving the mouse (pan function).

Zoom **Feature available only by web server.** Zoom in and out the graphic by scrolling the mouse wheel.

8.2. Real Time

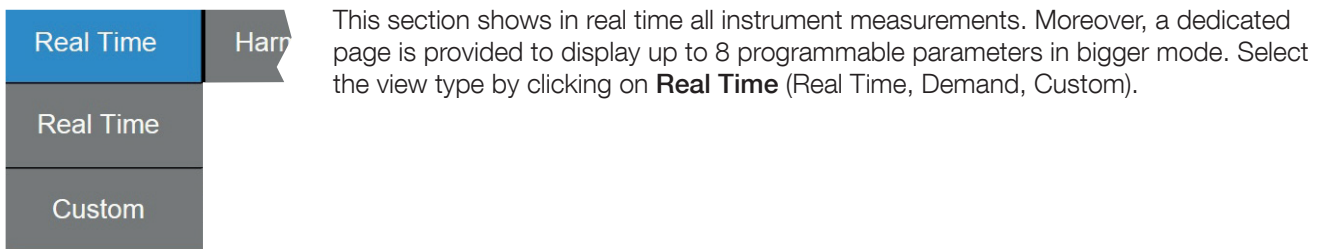

This section shows in real time all instrument measurements. Moreover, a dedicated page is provided to display up to 8 programmable parameters in bigger mode. Select the view type by clicking on **Real Time** (Real Time, Demand, Custom).

In Real Time view, select the desired sub-menu to display the corresponding real time values.

Real Time	Harmonics	Graphics	Recordings	Status	Setup	Administration
REAL TIME						
Voltages	Currents	Powers	Energy	Unbalance	Deviations	Signalling
Parameter			Value	MU		
Phase 1 to Neutral Voltage (U1N)			213.83	V		
Phase 2 to Neutral Voltage (U2N)			213.89	V		
Phase 3 to Neutral Voltage (U3N)			213.93	V		
Line 1 to 2 Voltage (U12)			0.00	V		
Line 2 to 3 Voltage (U23)			0.00	V		
Line 3 to 1 Voltage (U31)			0.00	V		
System Voltage (UΣ)			0.00	V		
Line 4 to Neutral Voltage (U4N)			213.84	V		
Line 4 to Phase 1 Voltage (U41)			0.10	V		
Line 4 to Phase 2 Voltage (U42)			0.07	V		
Line 4 to Phase 3 Voltage (U43)			0.12	V		
System Frequency (f)			49.589	Hz		
Phase Sequence			---			

Voltages	Currents	Powers	Energy	Unbalance	Deviations	Flicker	Distortions	Signalling
U1N	I1	P1	+kWh	U0	UdevU1N	Pst1	THDU1N	U1N-MS1
U2N	I2	P2	+kvarh-L	U1	UdevU2N	Pst2	THDU2N	U2N-MS1
U3N	I3	P3	+kvarh-C	U2	UdevU3N	Pst3	THDU3N	U3N-MS1
U12	I4	PΣ	-kWh	U0	UdevU12	Plt1	THDU12	U1N-MS2
U23	I5	S1	-kvarh-L	U2	UdevU23	Plt2	THDU23	U2N-MS2
U31	IΣ	S2	-kvarh-C		UdevU31	Plt3	THDU31	U3N-MS2
UΣ		S3	kVAh		OdevU1N		THDI1	U1N-MS3
U4		SΣ			OdevU2N		THDI2	U2N-MS3

Voltages	Currents	Powers	Energy	Unbalance	Deviations	Flicker	Distortions	Signalling
U41		Q1			OdevU3N		THDI3	U3N-MS3
U42		Q2			OdevU12		DPF1	U1N-MS4
U43		Q3			OdevU23		DPF2	U2N-MS4
f		$Q\Sigma$			OdevU31		DPF3	U3N-MS4
PhSeq		TPF1					K1	U1N-MS5
		TPF2					K2	U2N-MS5
		TPF3					K3	U3N-MS5
		$TPF\Sigma$						

Some parameters may not be available according to the set wiring mode (refer to the parameter table in section “7.3. Measurement monitoring”, page 24). The above table content is valid in 3.4.3 wiring mode. In case of a wiring mode with reduced number of parameters, the sub-menu will change.

In custom view, the dedicated Custom page with 8 programmable parameters will be displayed. For Custom page setup refer to section “8.7.1. General”, page 80

Real Time	Harmonics	Graphics	Recordings	Status	Setup	Administration
U1N	213.61	V	U12	0.00	V	
U2N	213.68	V	U23	0.00	V	
U3N	213.72	V	U31	0.00	V	
F	49.595	Hz	Ph	---		

To zoom in a single parameter, press the desired parameter area (e.g. U1N)

The parameter value will be displayed bigger as follows:

Real Time	Harmonics	Graphics	Recordings	Status	Setup	Administration
UΣ	398.91	V				



Note:

- for each measurement unit, the multiplying factor (k, M, G) can change according to the set parameter full scale.
- in the measurement unit field (MU), C or L will be displayed for each parameter of True power factor (PF) and Displacement Power Factor (DPF): C=capacitive/leading value, L=inductive/lagging value.
- the Phase Sequence field shows the voltage phase sequence in a 3 phase system. In case of wrong connection, this field will display 132. If this field shows “---”, it means undefined phase sequence: 2 phases are short-circuited or 1 phase is missing.

8.3. Harmonics

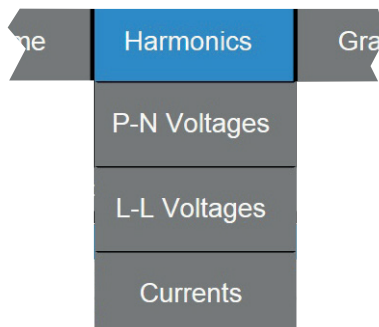

This section shows voltage and current harmonics and interharmonics in table or graphic mode. Select the harmonic type by clicking on **Harmonics** (P-N Voltages, L-L Voltages, Currents).

According to the selection (P-N Voltages, L-L Voltages, Currents), the first 12 harmonic component values will be displayed in a table on the left side and the corresponding interharmonics will be displayed in a table on the right side. For each voltage/current parameter the THD value is shown.

Press **Next** button to display the next 12 harmonic components. Turn back to the previous 12 harmonic components with **Prev** button.

By mouse left button or by using **Up** or **Down** button, select the main harmonic: the selected harmonic will be grey enhanced and the corresponding interharmonics will be displayed in the table on the right side.

In the interharmonic table, the first value row represents the selected main harmonic and the following values represent the interharmonics. If the system frequency is set to 50 Hz, 9 interharmonics are displayed, otherwise if it is set to 60 Hz the displayed interharmonics will be 11.

Real Time	Harmonics	Graphics	Recordings	Status	Setup	Administration			
P-N VOLTAGE HARMONICS & INTERHARMONICS									
Table		Graph		◀ Prev Next ▶ ▲ Up ▼ Down					
Harmonics		Voltage U1N	Voltage U2N	Voltage U3N	Interharmonics		Voltage U1N	Voltage U2N	Voltage U3N
THD		2.64 %	2.64 %	2.64 %	THD		2.64 %	2.64 %	2.64 %
Index	Frequency	Value [V]	Value [V]	Value [V]	Index	Frequency	Value [V]	Value [V]	Value [V]
DC	0.0Hz	0.05	0.02	0.01	DC	0.0Hz	0.05	0.02	0.01
1	49.1Hz	0.08	0.08	0.08	B1	4.9Hz	0.02	0.02	0.02
2	98.2Hz	0.04	0.04	0.04	B2	9.8Hz	0.03	0.03	0.03
3	147.3Hz	0.03	0.03	0.03	B3	14.7Hz	0.12	0.12	0.12
4	196.4Hz	0.19	0.19	0.19	B4	19.6Hz	0.46	0.47	0.46
5	245.5Hz	0.28	0.28	0.28	B5	24.6Hz	0.63	0.64	0.64
6	294.6Hz	0.16	0.16	0.16	B6	29.5Hz	0.55	0.55	0.55
7	343.7Hz	0.02	0.02	0.02	B7	34.4Hz	0.16	0.16	0.16
8	392.8Hz	0.05	0.05	0.05	B8	39.3Hz	0.30	0.30	0.30
9	441.9Hz	0.01	0.01	0.01	B9	44.2Hz	0.08	0.08	0.08
10	491.0Hz	3.17	3.18	3.18					
11	540.1Hz	0.03	0.03	0.03					
12	589.2Hz	0.05	0.05	0.05					
13	638.3Hz	0.03	0.03	0.03					

To switch on graphic view, press **Graph** button.

The phase/line parameter can be selected by a tab above the graph and the harmonic percentage values are represented on the vertical axis as absolute or percentage values according to the set Harmonic display mode.

On the vertical axis the scale changes automatically (auto-scaling) according to:

- the maximum detected harmonic, if Harmonic display mode is set as Absolute
- the set nominal voltage+10% about, in case of voltage harmonics
- the set CT primary+10% about, in case of current harmonics

On the horizontal axis, up to 50th harmonics can be represented, according to the **First Index** (start harmonic component) and **Last Index** fields (last harmonic component). Enabling the **Sync Indexes** (ON), the horizontal axis will maintain the same span if the First or the Last Index changes.

The labels on the tab selection change according to the viewed range.

The THD percentage value is displayed above each phase/line parameter graphic.

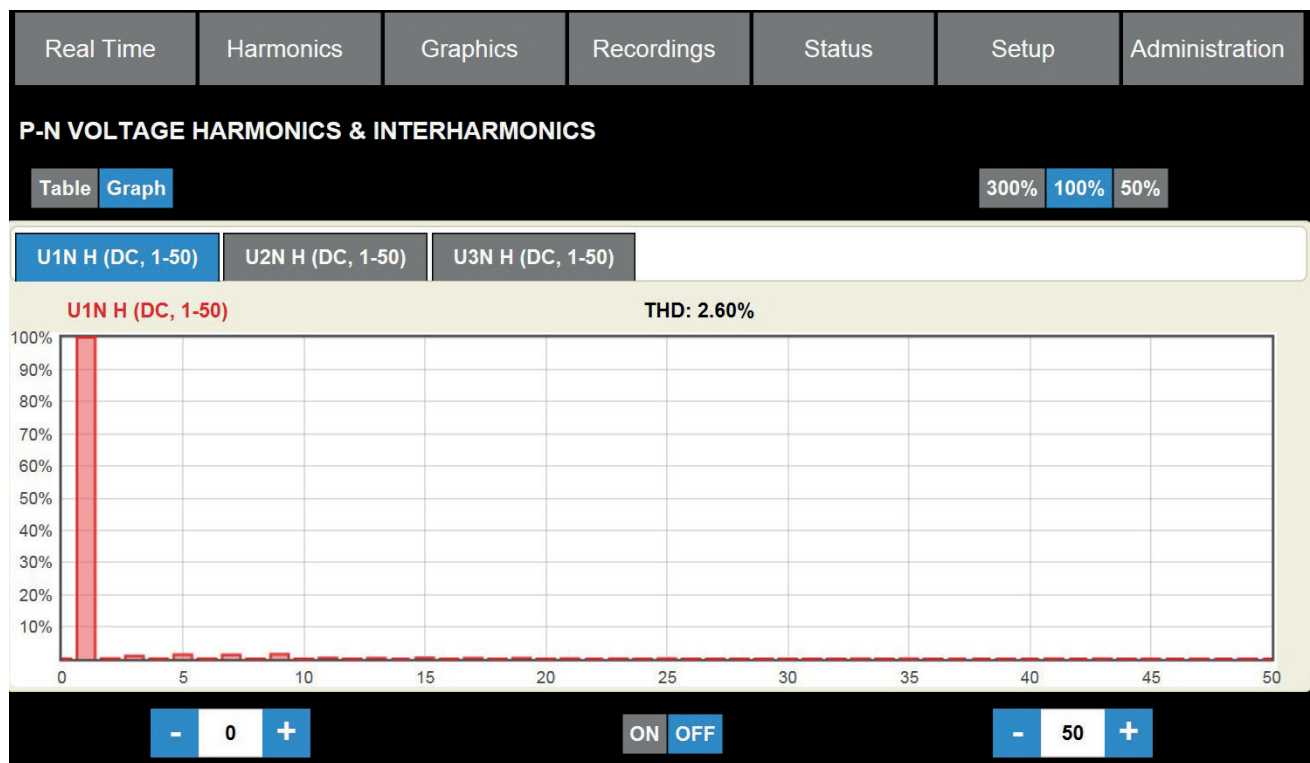

To zoom the horizontal axis and display interharmonics, the **Last index** must be 5 units greater than the **First Index**. Refer to the following picture.

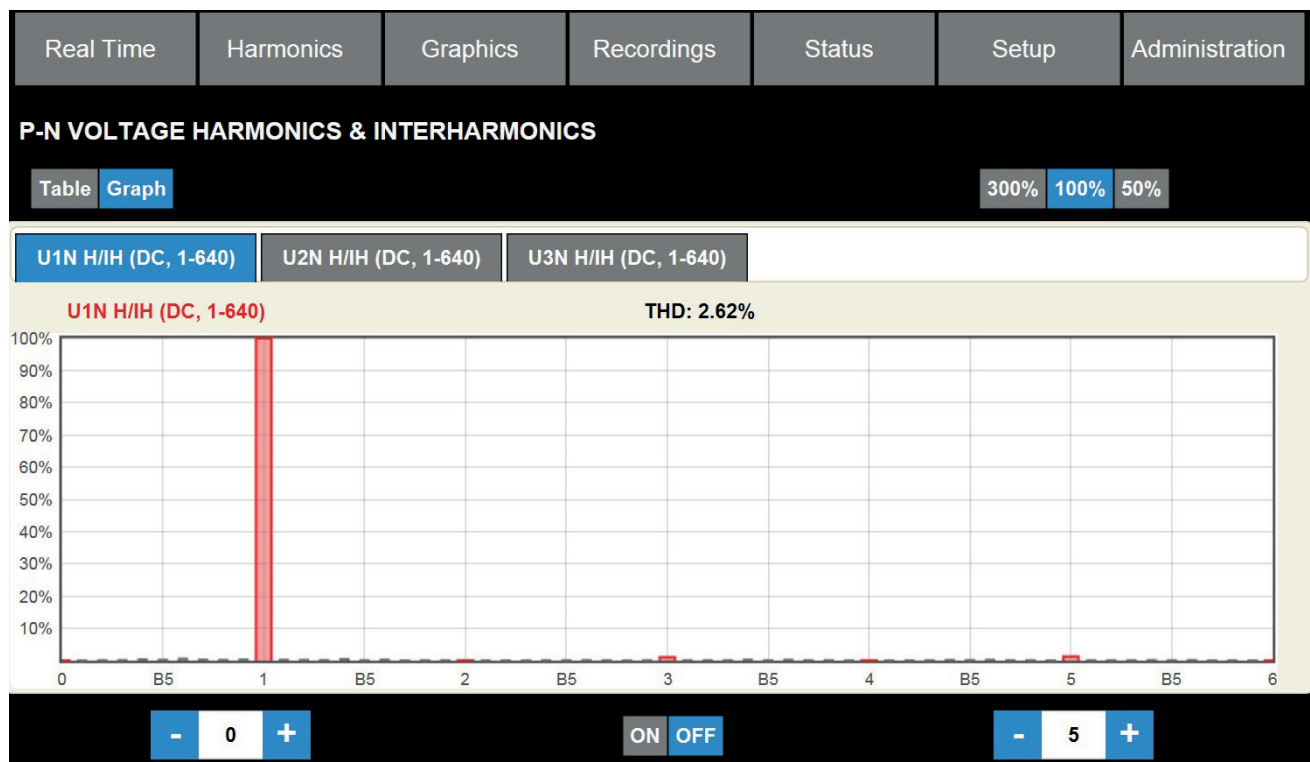

To switch back on table view, press **Table** button.

Some parameters may not be available according to the set wiring mode (refer to the parameter table in section “7.3. Measurement monitoring”, page 24).

8.4. Graphics

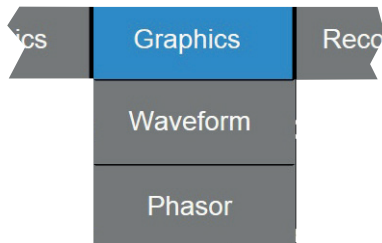

This section shows the voltage and current waveforms or phasors according to the selection. Select the graphic type by clicking on **Graphics** (Waveform, Phasor, Demand).

In Waveform view the voltage scale is represented on the left vertical axis, the current scale on the right vertical axis. The horizontal axis shows the period time in ms. For both axis (vertical and horizontal) the scale changes automatically according to the measurements (auto-scaling).

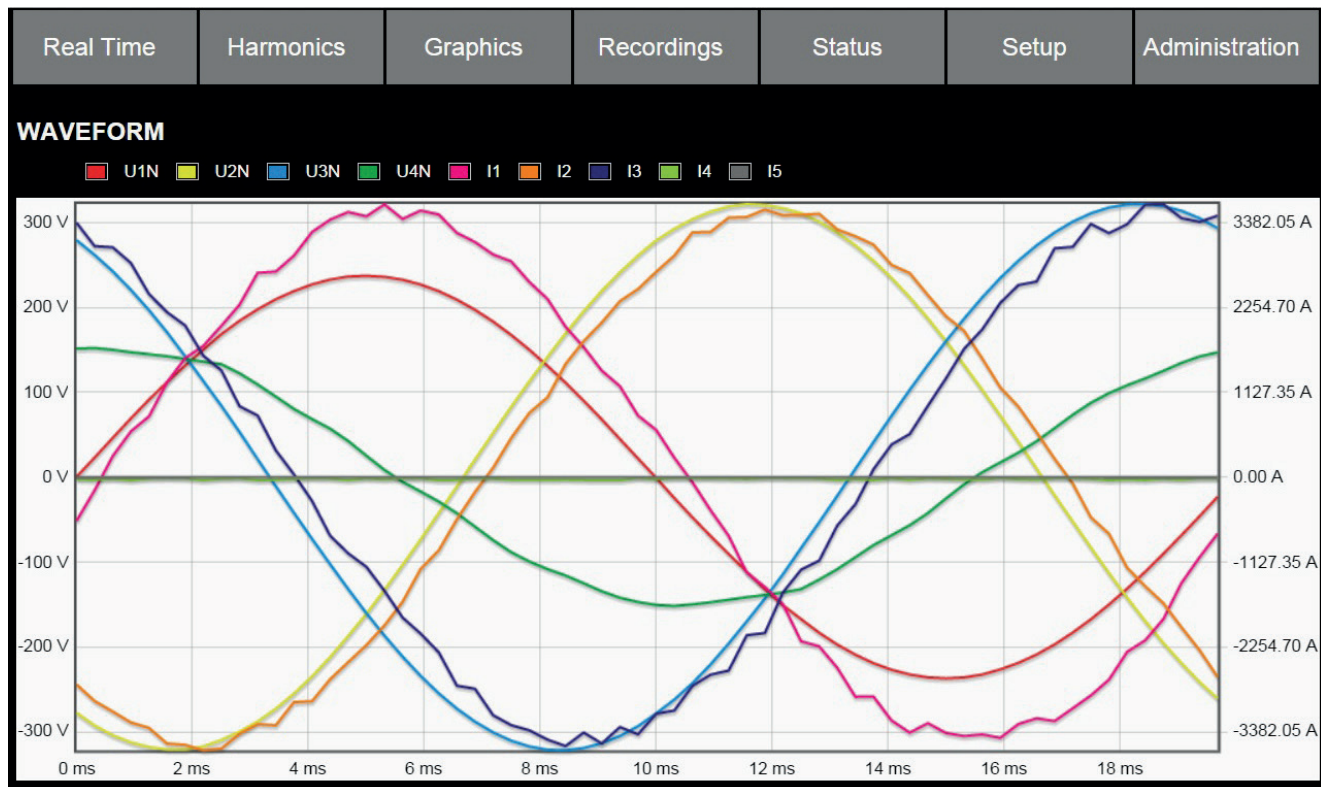

For both views (Waveform, Phasor) the signals have different colours according to the parameter type, refer to the legend above the graphics. Some parameters may not be available according to the set wiring mode (refer to the parameter table in section “7.3. Measurement monitoring”, page 24).

With mouse cursor over the graphic, a red crosshair will be shown. Move the crosshair over the waveform to show information (parameter, period time and value).

For both views (Waveform, Phasor) parameters can be disabled/enabled. To disable a parameter, click on the corresponding square: the square becomes blank and the parameter wave or phasor disappears (see example below with U4N parameter disabled). Both views (Waveform, Phasor) show the same parameter status (enabled/ disabled).

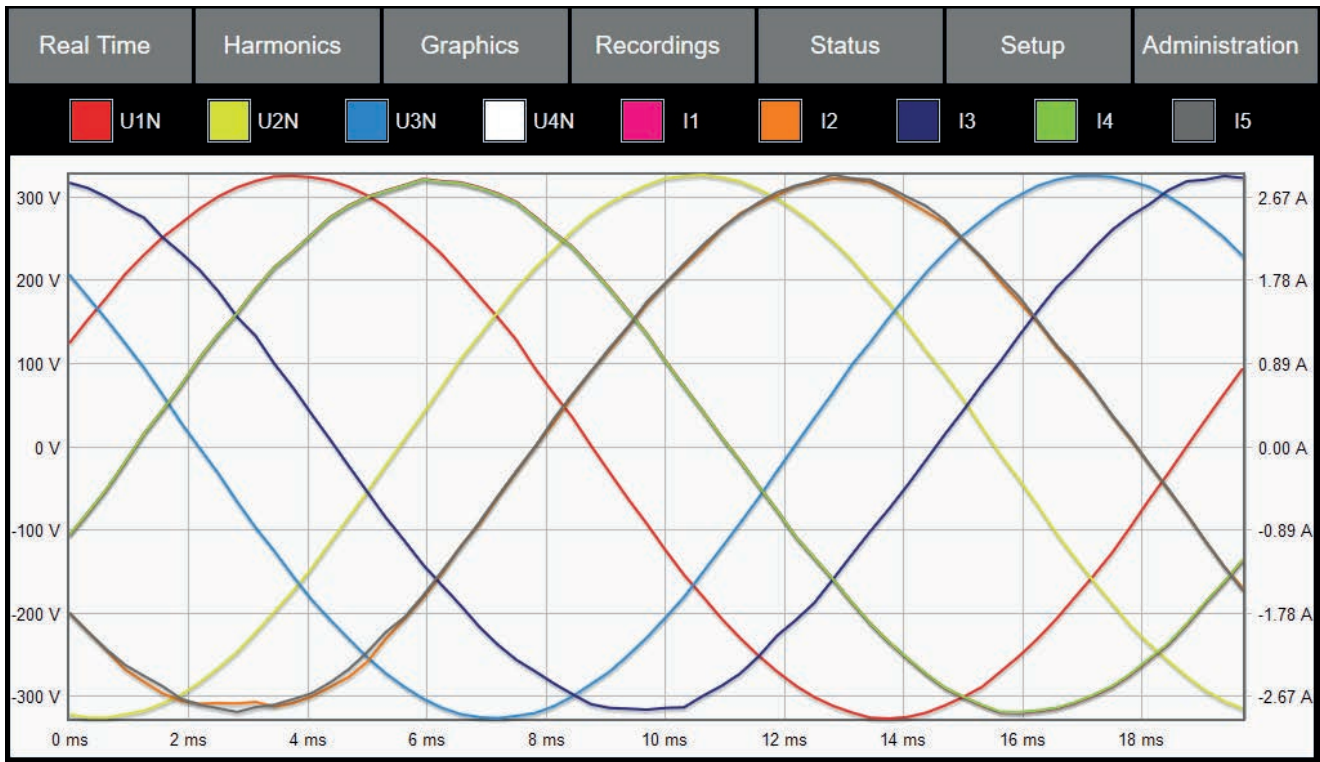

In the Phasor view, on the right side main real time voltage and current values are displayed as well as the phase angles.

In this example, the Phasor view is displayed with U4N parameter disabled, as the previous Waveform view. Waveform and Phasor views have the same enabled/disabled parameters.

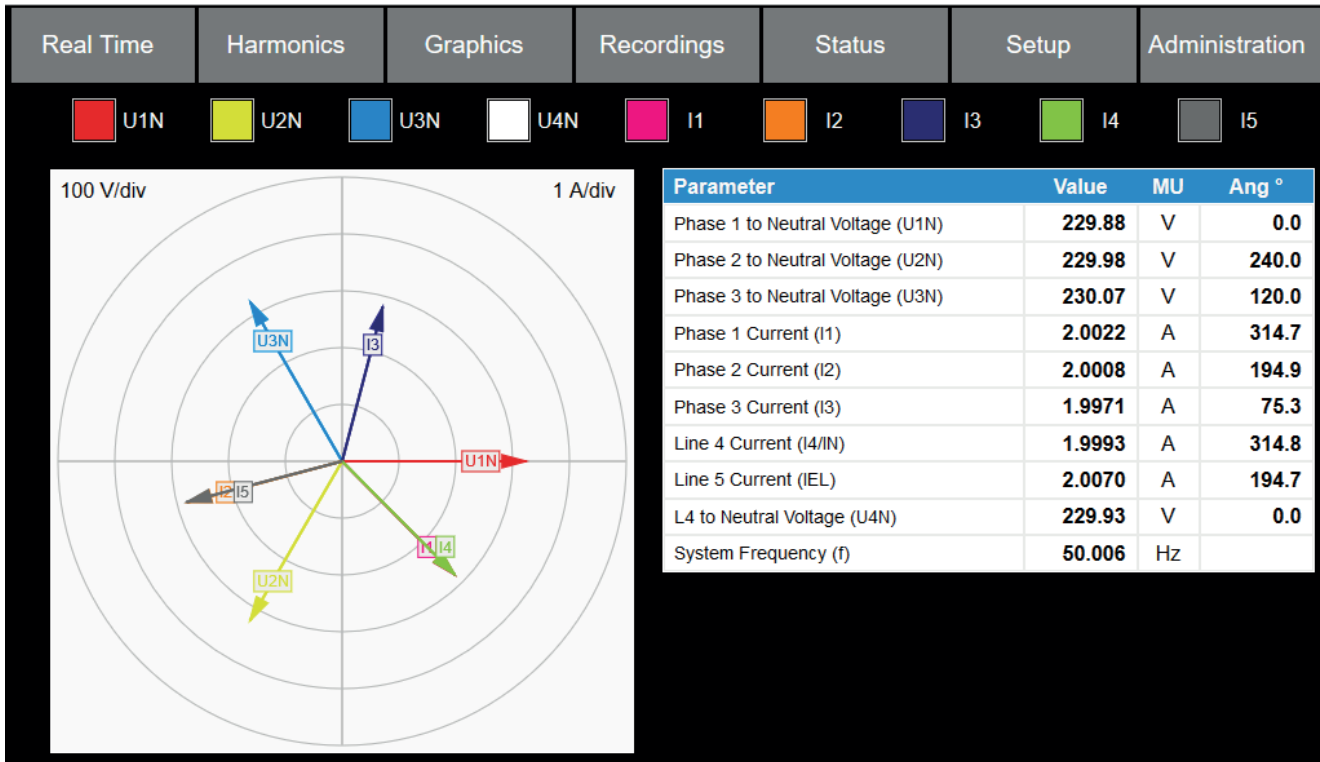

In the daily Demand view (only DMD), select the parameter to be displayed ($\pm I \sum DMD$, $\pm P \sum DMD$, $\pm Q \sum DMD$, $\pm S \sum DMD$, $\pm TPF \sum DMD$) by the drop-down menu. The parameter scale is represented on the left vertical axis. The horizontal axis shows the daily time in hours. For vertical axis the scale changes automatically according to the selected parameter.

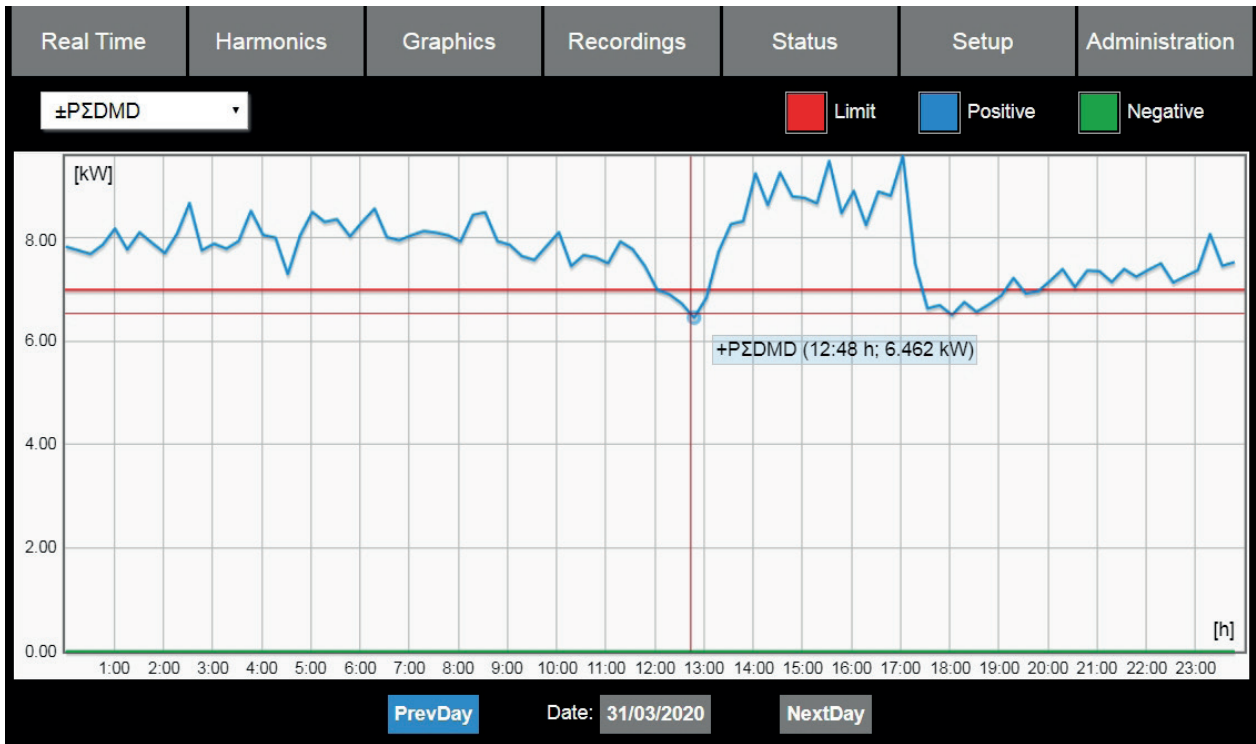

Different colours are used to identify the positive and negative values of the selected parameter. The limit is a static graphic line, programmable individually for each power P, Q, S, and it may represent the contractual power level. In this way the user has visual information if the demand power has overtaken the limit, and it may be penalised due to overconsumption. The **PrevDay** button allows to display trends of previous days. With **NextDay** button turns back on the next day. The date button is a datepicker, for a quick date selection.

With mouse cursor over the graphic, a red crosshair will be shown. Move the crosshair over the trend to show information about the detected demand (parameter, timestamp and value).

Note: the Demand graphic is available if at least one Demand value was recorded. If no Demand value was recorded, the page will not provide graphical information and the user will be notified with a warning message.

8.5. Recordings

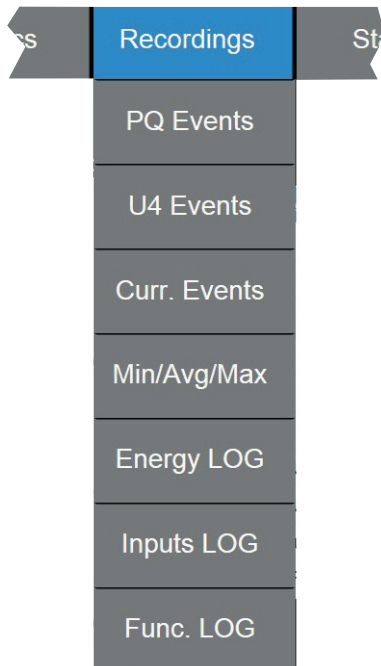

This section allows to manage the instrument recordings.

It is possible to display:

- Event summary
- Graphic preview for each event raw data (RMS trend and waveforms)
- Min/Avg/Max file list
- LOG for energy counters, digital inputs and instrument functional LOG

Moreover, it is possible to download and delete the recordings.

Select the recording type by clicking on **Recordings** (PQ Events, U4 Voltage Events, Current Events, Min/Avg/Max, Energy counter LOG, Inputs LOG, Demand log, Functional LOG).



Note: when the memory is full, the loading of Recording pages will take longer. During page loading, a window or symbol can be displayed according to the instrument use:

- by web server: a pop-up window will be shown to indicate page loading
- by instrument display: a loading symbol will appear to indicate page loading

Please wait until the Recording page will be loaded and displayed.



Note: when the memory is full, it is not possible to download recordings. In this case, it is suggested to set the FTP/SFTP automatic uploading as well as enable the automatic delete function. This action allows to store the recordings and to free the memory space, giving the possibility to download recordings.

8.5.1. PQ Events

Select **PQ Events** from **Recordings** menu, Fast voltage events will be shown. By this page, it is possible to display the following detected events, according to the selected sub-menu:





- Fast voltage
- Slow voltage
- Rapid voltage change
- Fast frequency
- Slow frequency
- Flicker
- Unbalance ratio
- Voltage THD
- Mains Signalling

In these pages, the event data is available only after event detection as well as enabled thresholds (refer to section “8.7.2. Thresholds”, page 83). The event pages are following described.



FAST VOLTAGE EVENTS

The fast voltage events are detections about voltage sags, swells interruptions or transients. To store this event type, set the corresponding thresholds (refer to section “8.7.2. Thresholds”, page 83).

In this page, the recorded event summary is shown.

Real Time	Harmonics	Graphics	Recordings	Status	Setup	Administration		
3P FAST VOLTAGE EVENTS SUMMARY						 		
Fast Volt.	Slow Volt.	Rapid V Chg.	Fast Freq.	Slow Freq.	Flicker	Unbal.Ratio	THD Volt	MS
Ev.	L1	L2	L3	Descr.	Start	Duration	Res/Max	View
1	X	X	X	Interr.	23/06/2016 11:40:41,88	00:00:01,01	0.00	 

For each recorded event, the following data is displayed:

Ev.	Event ID number.
L1, L2, L3	Phases/lines involved in the event.
Descr.	Event type. Sag=sag, Swell=swell, Interr.=interruption, Trans=transient
Start	Event start date and time with 10 ms accuracy (dd/mm/yyyy hh:mm:ss,cc).
Duration	Event length with 10 ms accuracy (hh:mm:ss,cc). In case of transient, this value is expressed in micro seconds (µs).
Res/Max	Extreme voltage value detected during the event (V or kV, according to the set PT value): <ul style="list-style-type: none"> • Residual in case of voltage sags or interruptions • Maximum in case of voltage swells • Voltage difference between the highest sample value during the transient event and the last sample value before the event
View	In this column two buttons are available for event graphic preview about: <ul style="list-style-type: none"> • the ½ cycle RMS values, by clicking on the first button  • the waveforms, by clicking on the second button 

-  Note:
- the raw data preview (RMS and waveforms) is not available for events with duration higher than 6.7 s.
 - the raw data preview (RMS values) is not available for transient events.
 - the raw data preview (RMS and waveforms) is an approximate function in graphic format. For an accurate analysis, refer to the downloaded PQDIF file.

SLOW VOLTAGE EVENTS

The slow voltage events are detections about extreme voltage values on a 1 minute period time. To store this event type, set the corresponding thresholds (refer to section “8.7.2. Thresholds”, page 83).

In this page, the recorded event summary is shown.

Real Time	Harmonics	Graphics	Recordings	Status	Setup	Administration		
3P SLOW VOLTAGE EVENTS LIST								
Fast Volt.	Slow Volt.	Rapid V Chg.	Fast Freq.	Slow Freq.	Flicker	Unbal.Ratio	THD Volt	MS
Ev.	L1	L2	L3	Descr.	Start	Duration	Res/Max	
1	X			Low	17/08/2016 15:14:00,00	00:05:00,02	167.00	

For each recorded event, the following data is displayed:

Ev.	Event ID number.
L1, L2, L3	Phases/lines involved in the event.
Descr.	Event type. Low=low voltage, High=high voltage
Start	Event start date and time with 10 ms accuracy (dd/mm/yyyy hh:mm:ss,cc).
Duration	Event length with 10 ms accuracy (hh:mm:ss,cc).
Res/Max	Extreme voltage value detected during the event (V or kV, according to the set PT value): <ul style="list-style-type: none"> • Residual in case of low voltage • Maximum in case of high voltage

RAPID VOLTAGE CHANGES

The rapid voltage changes are detections about phase/line voltage variations. To store this event type, refer to section “8.7.2. Thresholds”, page 83

In this page, the recorded event summary is shown.

Real Time	Harmonics	Graphics	Recordings	Status	Setup	Administration		
3P RAPID VOLTAGE CHANGES EVENT LIST								
Fast Volt.	Slow Volt.	Rapid V Chg.	Fast Freq.	Slow Freq.	Flicker	Unbal.Ratio	THD Volt	MS
Ev.	L1	L2	L3	Start	Duration	ΔU_{max}	ΔU_{ss}	
1	X			17/08/2016 16:01:14,57	0:00:00,630	23.20	20.04	
2	X			17/08/2016 16:01:58,54	0:00:00,649	21.71	20.05	















For each recorded event, the following data is displayed:

Ev.	Event ID number.
L1, L2, L3	Phases/lines involved in the event.
Start	Event start date and time with 10 ms accuracy (dd/mm/yyyy hh:mm:ss,cc).
Duration	Event length with 1 ms accuracy (h:mm:ss,fff).
ΔU_{max}	Maximum absolute difference between any of the values during the event and the final steady state value (V or kV, according to the set PT).
ΔU_{ss}	Absolute difference between the mean voltage of the first steady state after the event and the mean voltage of the steady state just prior to the event (V or kV, according to the set PT).



FAST FREQUENCY EVENTS

The fast frequency events are frequency detections in case of high/low frequency or manual trigger. To store this event type, set the corresponding thresholds (refer to section "8.7.2. Thresholds", page 83) or press button  (active only with low frequency threshold enabled).

In this page, the recorded event summary is shown.

Real Time	Harmonics	Graphics	Recordings	Status	Setup	Administration		
FAST FREQUENCY EVENTS								
<div style="text-align: right;">    </div>								
Fast Volt.	Slow Volt.	Rapid V Chg.	Fast Freq.	Slow Freq.	Flicker	Unbal.Ratio	THD Volt	MS
Ev.	Descr.	Start	Duration	Min/Max	View			
1	Man	16/08/2016 15:21:40,25	00:00:00,10	49.961				
2	Haut	17/08/2016 09:39:38,62	00:00:00,02	0.501				
3	Haut	17/08/2016 09:39:42,62	00:00:00,03	4.493				
4	Haut	17/08/2016 09:39:44,41	00:00:00,03	0.565				
5	Haut	17/08/2016 09:39:50,14	00:00:00,03	3.749				
6	Bas	17/08/2016 09:39:50,17	00:00:02,45	0.000				
<div style="display: flex; justify-content: space-between; align-items: center;"> 1..6 7..12 13..18 19..24 25..30 31..36 37..42 > </div>								

For each recorded event, the following data is displayed:

Ev.	Event ID number.
Descr.	Event type. Low=low frequency, High=high frequency, Man=manual trigger
Start	Event start date and time with 10 ms accuracy (dd/mm/yyyy hh:mm:ss,cc).
Duration	Event length with 10 ms accuracy (hh:mm:ss,cc).
Min/Max	Extreme frequency value detected during the event (Hz): <ul style="list-style-type: none"> • Minimum in case of low frequency • Maximum in case of high frequency
View	In this column two buttons are available for event graphic preview about: <ul style="list-style-type: none"> • the ½ cycle RMS values, by clicking on the first button  • the waveforms, by clicking on the second button 



Note:

- the raw data preview (RMS and waveforms) is not available for events with duration higher than 6.7 s.
- the raw data preview (RMS and waveforms) is an approximate function in graphic format. For an accurate analysis, refer to the downloaded PQDIF file.

SLOW FREQUENCY EVENTS

The slow frequency events are detections about high/low frequency values on a period time calculated according to the set integration time. To store this event type, set the corresponding thresholds (refer to section “8.7.2. Thresholds”, page 83).

In this page, the recorded event summary is shown.

Real Time	Harmonics	Graphics	Recordings	Status	Setup	Administration		
SLOW FREQUENCY EVENTS LIST								
<div style="text-align: right;">   </div>								
Fast Volt.	Slow Volt.	Rapid V Chg.	Fast Freq.	Slow Freq.	Flicker	Unbal.Ratio	THD Volt	MS
Ev.	Descr.		Start				Duration	Res/Max
1	Bas		17/08/2016 09:03:00,00				00:37:09,94	0.000
2	Bas		17/08/2016 09:40:40,00				00:00:10,00	0.416
3	Haut		17/08/2016 09:40:00,02				00:10:00,00	15.707
4	Bas		17/08/2016 09:50:00,00				00:00:40,00	0.000
5	Haut		17/08/2016 09:50:40,00				00:00:10,00	0.931
6	Bas		17/08/2016 09:50:50,00				00:00:20,00	0.109
7	Haut		17/08/2016 09:51:10,00				00:00:10,00	0.817
8	Bas		17/08/2016 09:51:20,00				00:00:30,00	0.099
9	Haut		17/08/2016 09:51:50,00				00:00:10,00	0.803
10	Bas		17/08/2016 09:52:00,00				00:01:10,00	0.000



For each recorded event, the following data is displayed:

Ev.	Event ID number.
Descr.	Event type. Low=low frequency, High=high frequency
Start	Event start date and time with 10 ms accuracy (dd/mm/yyyy hh:mm:ss,cc).
Duration	Event length with 10 ms accuracy (hh:mm:ss,cc).
Min/Max	Extreme frequency value detected during the event (Hz): <ul style="list-style-type: none"> • Minimum in case of low frequency • Maximum in case of high frequency

FLICKER EVENTS

The long term flicker events are detections about high Plt values on a 2 hour period time. To store this event type, set the corresponding thresholds (refer to section “8.7.2. Thresholds”, page 83).

In this page, the recorded event summary is shown.

Real Time		Harmonics		Graphics		Recordings		Status		Setup		Administration	
FLICKER EVENTS LIST													
Fast Volt.	Slow Volt.	Rapid V Chg.	Fast Freq.	Slow Freq.	Flicker	Unbal.Ratio	THD Volt	MS					
Ev.	L1	L2	L3	Start			Duration	Max					
1	X		X	16/08/2016 15:21:40,19			00:07:10,34	2.221					
2	X		X	16/08/2016 15:25:27,55			00:00:01,07	2.183					
3	X		X	16/08/2016 15:25:29,38			00:00:00,54	2.177					
4	X		X	16/08/2016 15:25:31,59			00:00:01,92	2.182					
5	X		X	16/08/2016 15:25:35,36			00:00:01,17	2.185					
6	X	X	X	17/08/2016 17:16:13,95			00:02:35,08	2.535					



For each recorded event, the following data is displayed:

Ev.	Event ID number.
L1, L2, L3	Phases/lines involved in the event.
Start	Event start date and time with 10 ms accuracy (dd/mm/yyyy hh:mm:ss,cc).
Duration	Event length with 10 ms accuracy (hh:mm:ss,cc).
Max	Max Plt value detected during the event.

VOLTAGE UNBALANCE RATIO EVENTS

The slow voltage unbalance ratio events are detections about high u_2 (negative sequence ratio) and/or u_0 (zero sequence ratio) values on a 10 minute period time. To store this event type, set the corresponding thresholds (refer to section “8.7.2. Thresholds”, page 83).

In this page, the recorded event summary is shown.

Real Time		Harmonics		Graphics		Recordings		Status		Setup		Administration	
3P UNBALANCE EVENTS LIST													
Fast Volt.	Slow Volt.	Rapid V Chg.	Fast Freq.	Slow Freq.	Flicker	Unbal.Ratio	THD Volt	MS					
Ev.	Descr.		Start			Duration	Max						
1	u2		17/08/2016 15:20:00,09			00:09:59,95	5.430						
2	u0		17/08/2016 15:20:00,09			00:09:59,95	5.454						



For each recorded event, the following data is displayed:

Ev.	Event ID number.
Descr.	Unbalance parameter which triggered the event. $\mu 2$ =negative sequence ratio, $\mu 0$ =zero sequence ratio.
Start	Event start date and time with 10 ms accuracy (dd/mm/yyyy hh:mm:ss,cc).
Duration	Event length with 10 ms accuracy (hh:mm:ss,cc).
Max	Max value (of triggering unbalance parameter) detected during the event.

VOLTAGE THD EVENTS

The slow voltage THD events are detections about high voltage THD values on a 10 minute period time. To store this event type, set the corresponding thresholds (refer to section "8.7.2. Thresholds", page 83).

In this page, the recorded event summary is shown.

Real Time	Harmonics	Graphics	Recordings	Status	Setup	Administration		
3P VOLTAGE THD EVENTS LIST								
<div style="text-align: right;">   </div>								
Fast Volt.	Slow Volt.	Rapid V Chg.	Fast Freq.	Slow Freq.	Flicker	Unbal.Ratio	THD Volt	MS
Ev.	L1	L2	L3	Start		Duration	Max	
1	X	X	X	23/10/2015 09:30:00,02		00:10:00,00	21.17	
2	X			23/10/2015 19:00:00,02		00:20:00,00	05.23	
3		X	X	23/10/2015 23:50:00,02		00:40:00,00	10.07	
4	X		X	24/10/2015 06:40:00,02		01:00:00,00	15.54	
5			X	24/10/2015 12:10:00,02		00:10:00,00	27.35	
6	X	X		25/10/2015 08:30:00,02		00:20:00,00	06.37	
7		X		26/10/2015 16:00:00,02		00:10:00,00	09.19	
8	X	X	X	27/10/2015 09:50:00,02		00:30:00,00	06.73	
9	X	X	X	28/10/2015 14:30:00,02		00:20:00,00	10.81	
10			X	29/10/2015 08:20:00,02		00:10:00,00	13.49	
11	X			29/10/2015 10:10:00,02		00:10:00,00	07.18	
12	X	X	X	30/10/2015 03:00:00,02		01:40:00,00	05.29	

For each recorded event, the following data is displayed:

Ev.	Event ID number.
L1, L2, L3	Phases/lines involved in the event.
Start	Event start date and time with 10 ms accuracy (dd/mm/yyyy hh:mm:ss,cc).
Duration	Event length with 10 ms accuracy (hh:mm:ss,cc).
Max	Max voltage THD value detected during the event (%).

MAINS SIGNALLING EVENTS

The Mains Signalling events are detections of high Mains Signalling voltage on the supply voltage (refer to section “8.7.2. Thresholds”, page 83).

In this page, the recorded event summary is shown.

Real Time	Harmonics	Graphics	Recordings	Status	Setup	Administration		
3P VOLTAGE THD EVENTS LIST								
Fast Volt.	Slow Volt.	Rapid V Chg.	Fast Freq.	Slow Freq.	Flicker	Unbal.Ratio	THD Volt	MS
Ev.	Phase/Line	MS Index	Start	Duration	Umax			
1	1	1	15/01/2016 16:32:18	00:00:18	39.05			
2	2	1	15/01/2016 16:32:18	00:00:18	37.51			
3	3	1	15/01/2016 16:32:18	00:00:18	36.52			













For each recorded event, the following data is displayed:

Ev.	Event ID number.
Phase/Line	Phases/lines involved in the event.
MS Index	Index of Mains Signalling involved in the event.
Start	Event start date and time with 1 s accuracy (dd/mm/yyyy hh:mm:ss).
Duration	Event length with 1 s accuracy (hh:mm:ss).
UMax	Max Mains Signalling voltage detected during the event (V or kV, according to the set PT).



8.5.2. U4 Voltage Events

Select **U4 Voltage Events** from **Recordings** menu, a new page is shown to display details about the detected U4 voltage events.

The fast U4 voltage events are detections about U4 voltage sags or swells. To store this event type, set the corresponding thresholds (refer to section “8.7.2. Thresholds”, page 83).

Real Time	Harmonics	Graphics	Recordings	Status	Setup	Administration
U4 VOLTAGE EVENTS SUMMARY						
Ev.	Descr.	Start	Duration	Res/Max	View	
1	Sag	30/09/2015 01:21:10,37	00:00:03,02	0.45	 	
2	Sag	30/09/2015 01:21:29,42	00:00:01,61	23.90	 	
3	Swell	30/09/2015 01:22:53,78	00:00:01,01	260.28	 	
4	Sag	30/09/2015 01:23:00,64	00:00:00,96	199.72	 	
5	Swell	30/09/2015 01:23:04,06	00:00:00,74	258.26	 	
6	Sag	30/09/2015 01:23:11,50	00:00:01,27	19.85	 	

For each recorded event, the following data is displayed:















Ev.	Event ID number.
Descr.	Event type. Sag=sag, Swell=swell
Start	Event start date and time with 10 ms accuracy (dd/mm/yyyy hh:mm:ss,cc).
Duration	Event length with 10 ms accuracy (hh:mm:ss,cc).
Res/Max	Extreme 4th voltage value detected during the event (V or kV, according to the set PT value): <ul style="list-style-type: none"> • Residual in case of 4th voltage sags • Maximum in case of 4th voltage swells
View	In this column two buttons are available for event graphic preview about: <ul style="list-style-type: none"> • the ½ cycle RMS values, by clicking on the first button  • the waveforms, by clicking on the second button 

 Note:
- the raw data preview (RMS and waveforms) is not available for events with duration higher than 6.7 s.
- the raw data preview (RMS and waveforms) is an approximate function in graphic format. For an accurate analysis, refer to the downloaded PQDIF file.



8.5.3. Current Events

Select **Current Events** from **Recordings** menu, a new page is shown to display details about the detected current events.

The current events are detections about current peaks. To store this event type, set the corresponding thresholds (refer to section “8.7.2. Thresholds”, page 83).

Real Time	Harmonics	Graphics	Recordings	Status	Setup	Administration	
OVERCURRENT EVENTS SUMMARY  							
Ev.	L1	L2	L3	Start	Duration	Max	View
1	X		X	16/08/2016 15:21:40,19	00:07:10,34	2221.5	 
2	X		X	16/08/2016 15:25:27,55	00:00:01,07	2183.0	 
3	X		X	16/08/2016 15:25:29,38	00:00:00,54	2177.5	 
4	X		X	16/08/2016 15:25:31,59	00:00:01,92	2182.4	 
5	X		X	16/08/2016 15:25:35,36	00:00:01,17	2185.8	 
6	X	X	X	17/08/2016 17:16:13,95	00:02:35,08	2535.4	 

For each recorded event, the following data is displayed:

Ev.	Event ID number.
L1, L2, L3	Phases involved in the event.
Start	Event start date and time with 10 ms accuracy (dd/mm/yyyy hh:mm:ss,cc).
Duration	Event length with 10 ms accuracy (hh:mm:ss,cc).
Max	Maximum current value detected during the event (A or kA, according to the set FS value).
View	In this column two buttons are available for event graphic preview about: <ul style="list-style-type: none"> • the ½ cycle RMS values, by clicking on the first button  • the waveforms, by clicking on the second button 









Note:

- the raw data preview (RMS and waveforms) is not available for events with duration higher than 6.7 s.
- the raw data preview (RMS and waveforms) is an approximate function in graphic format. For an accurate analysis, refer to the downloaded PQDIF file.



8.5.4. Min/Avg/Max

Select Min/Avg/Max from Recordings menu, a new page for Min/Avg/Max recording file list will be displayed.

This list is displayed only after value recording, if previously enabled (refer to section “8.7.3. Min/Avg/Max”, page 87).

Real Time	Harmonics	Graphics	Recordings	Status	Setup	Administration
MIN/AVG/MAX RECORDINGS FILE LIST						 
File	Start	End	Data			
1	22/06/2016 07:00:00	22/06/2016 07:00:00				
2	22/06/2016 19:20:00	23/06/2016 00:00:00				
3	23/06/2016 10:50:00	23/06/2016 10:50:00				

For each Min/Avg/Max file, the following data is displayed:

File	File ID number.
Start	Date and time when recording file is started (dd/mm/yyyy hh:mm:ss).
End	Date and time when recording file is stopped (dd/mm/yyyy hh:mm:ss).
Data	<p>Different operation can be performed according to the button:</p> <ul style="list-style-type: none">  Download the corresponding Min/Avg/Max file. A pop-up window will be shown to save data on the local PC. A PQDIF file will be downloaded.  Delete the corresponding Min/Avg/Max file, a message will be shown. Confirm with Yes, a password will be requested. Insert the administrator password and confirm with Yes, the recording will be erased and no more retrievable.

8.5.5. Data LOG















Select Data LOG from Recordings menu, Frequency LOG will be shown. Depending on the selected sub-menu, it is possible to display the following LOG, according to the instrument version:

- Frequency LOG
- Counter LOG
- Demand LOG (only DMD)
- Inputs LOG

The LOG pages are following described.

FREQUENCY LOG

The Frequency LOG list is displayed if the Frequency LOG recording was previously enabled (refer to section 8.7.5).

Real Time	Harmonics	Graphics	Recordings	Status	Setup	Administration
RECORDINGS - FREQUENCY LOG						 
Freq. Log	Counter Log	DMD Log	Inputs Log			
File	Start	End	Data			
1	22/03/2020 08:17:20	22/03/2020 12:46:20				
2	22/03/2020 12:46:40	22/03/2020 12:48:20				
3	22/03/2020 12:48:40	24/03/2020 06:22:00				
4	24/03/2020 06:22:20	29/03/2020 03:10:00				
5	29/03/2020 03:10:10	29/03/2020 04:47:40				
6	29/03/2020 04:47:40	01/04/2020 14:53:30				



For each status change, the following data is displayed:

File File progressive number.

Start Date and time when recording is started (dd/mm/yyyy hh:mm:ss).

End Date and time when recording is stopped (dd/mm/yyyy hh:mm:ss).

Data Different operation can be performed according to the button:

-  Download the corresponding Frequency LOG file. A pop-up window will be shown to save data on the local PC. A PQDIF file will be downloaded.
-  Delete the corresponding Frequency LOG file, a message will be shown. Confirm with **Yes**, a password will be requested. Insert the administrator password and confirm with **Yes**, the recording will be erased and no more retrievable.

COUNTER LOG

The Counter LOG list is displayed if the Counter LOG recording was previously enabled at a preset rate (refer to section 8.7.5).

File	Start	End	Data
1	26/05/2018 17:50:01	26/05/2018 17:50:01	
2	26/05/2018 18:00:00	01/08/2018 11:40:00	
3	01/08/2018 11:50:01	31/08/2018 08:50:00	
4	31/08/2018 09:00:01	28/10/2018 02:00:00	
5	28/10/2018 02:10:00	15/11/2018 11:40:00	
6	15/11/2018 11:50:00	26/11/2018 07:40:00	

For each status change, the following data is displayed:

File File progressive number.

Start Date and time when recording is started (dd/mm/yyyy hh:mm:ss).















End Date and time when recording is stopped (dd/mm/yyyy hh:mm:ss).

Data Different operation can be performed according to the button:

- Download the corresponding Energy counter LOG file. A pop-up window will be shown to save data on the local PC. A CSV file will be downloaded.
- Delete the corresponding Energy counter LOG file, a message will be shown. Confirm with **Yes**, a password will be requested. Insert the administrator password and confirm with **Yes**, the recording will be erased and no more retrievable.

DEMAND LOG

The Demand LOG list is displayed if the Demand LOG recording was previously enabled at a preset rate (refer to section 8.7.4).

Real Time	Harmonics	Graphics	Recordings	Status	Setup	Administration
DEMAND RECORDINGS FILE LIST  						
Freq. Log	Counter Log	DMD Log	Inputs Log			
File	Start	End	Data			
1	24/01/2020 13:55:00	24/01/2020 17:24:00				
2	24/01/2020 17:25:00	24/01/2020 23:59:00				
3	25/01/2020 00:00:00	25/01/2020 23:59:00				
4	26/01/2020 00:00:00	26/01/2020 23:59:00				
5	27/01/2020 00:00:00	27/01/2020 16:46:00				
6	27/01/2020 16:47:00	27/01/2020 23:59:00				
1..6	7..12	13..18	19..24	25..30	31..36	37..42 >



For each status change, the following data is displayed:

File File progressive number.

Start Date and time when recording is started (dd/mm/yyyy hh:mm:ss).

End Date and time when recording is stopped (dd/mm/yyyy hh:mm:ss).

Data Different operation can be performed according to the button:

-  Download the corresponding Demand LOG file. A pop-up window will be shown to save data on the local PC. A CSV file will be downloaded.
-  Delete the corresponding Energy counter LOG file, a message will be shown. Confirm with **Yes**, a password will be requested. Insert the administrator password and confirm with **Yes**, the recording will be erased and no more retrievable.

INPUTS LOG

The Inputs LOG is displayed if at least one digital input status is changed (refer to section 8.7.7).

Real Time	Harmonics	Graphics	Recordings	Status	Setup	Administration
DIGITAL INPUTS LOG EVENT LIST						
Freq. Log	Counter Log	DMD Log	Inputs Log			
Start		IN1	IN2	IN3	IN4	
30/01/2020 16:43:00		A	B	A	A	
30/01/2020 16:58:00		A	B	A	B	

For each status change, the following data is displayed:

Start Date and time when the status change is occurred (dd/mm/yyyy hh:mm:ss,cc).

IN1 ... IN4 Status for each digital input when the status change is occurred (A=high, B=low). N/A is displayed if the digital input was disabled at event time.

8.5.6. Demand MAX

Select Demand MAX from Recordings menu, the stored demand MAX values with timestamp will be displayed. All Demand MAX values stored for the actual periods (day, week, month) will be stored in the specific previous groups at the end of each period. Daily values will be shifted at 00:00 hours, weekly values will be shifted at 00:00 hours every monday, monthly values will be shifted at 00:00 hours of the first calendar day of the month. In each actual group, values and timestamp will be overwritten everytime the instrument calculates a demand value higher than the previous one.

Real Time	Harmonics	Graphics	Recordings	Status	Setup	Administration
DEMAND MAXIMUM VALUES						
Currents	Active Pow	Reactive Pow	Apparent Pow	True PF		
Parameter		Value	MU	Timestamp		
Phase 1 Current Demand MAX (I1DMDMAX)		25.48	A	01/04/2020 13:46:00		
Phase 2 Current Demand MAX (I2DMDMAX)		17.71	A	01/04/2020 13:46:00		
Phase 3 Current Demand MAX (I3DMDMAX)		14.92	A	01/04/2020 14:16:00		
Line 4 (I4/IN) Current Demand MAX (I4DMDMAX)		17.64	A	01/04/2020 10:16:00		
System Current Demand MAX (ISDMDMAX)		19.19	A	01/04/2020 14:16:00		
Line 5 (IEL) Current Demand MAX (I5DMDMAX)		0.14	A	01/04/2020 10:46:00		
		PrevMonth	ActMonth	PrevWeek	ActWeek	PrevDay ActDay

For each parameter (Currents, Active Pow, Reactive Pow, Apparent Pow, True PF), the following data is displayed:

Parameter	Name of parameter.
Value	Last stored demand MAX value of the corresponding parameter.
MU	Measuring unit of the corresponding parameter.
Timestamp	Date and time at demand MAX value detection (dd/mm/yyyy hh:mm:ss).

The following buttons allow to display demand MAX values according to the period time:

PrevMonth button	Demand MAX values saved for the previous month.
ActMonth button	Demand MAX values saved for the current month.
PrevWeek button	Demand MAX values saved for the previous week.
ActWeek button	Demand MAX values saved for the current week.
PrevDay button	Demand MAX values saved for the previous day.
ActDay button	Demand MAX values saved for the current day.

8.6. Status

This section shows the information and status about the instrument.

Real Time	Harmonics	Graphics	Recordings	Status	Setup	Administration
DEVICE INFORMATION & STATUS						
Parameter	Value / Status	Description				
Serial Number	B360Q60001	Device manufacturing serial number				
Manufacturing Year	2016	Device manufacturing year				
Calibration	17/06/2016	Device calibration date (recalibration suggested after 2 years)				
Configuration	1.0	Hardware configuration				
Version	alpha16 r.6132	Installed software version				
Display Version	2.1	Installed software version on Display interface				
IP Address	192.168.2.167	Front and rear Ethernet ports IP address				
MAC Address	70:B3:D5:43:00:7F	Device Ethernet port MAC address				
Internet	OK	Status of internet connection through the router				
GPS Status	-	RTC lock status on GPS signal				
Last Server Connection	-	Last connection to remote server for data transfer (date/hour)				
Data Transfer Result	-	Result of last connection for data transfer				
Memory	91%	Free memory space for recordings				
Battery	4.1V - Charged	Backup battery voltage and charging status				
Digital Inputs 1...4	OFF/OFF/OFF/OFF	Real time status of the Digital Input channels (1, 2, 3, 4)				
WiFi	OFF	WiFi module functional mode				
Last Restart	25/07/2016 19:46:53	Last device restart (date/hour)				

In this table, the following data is displayed:

Serial Number	Instrument serial number.
Manufacturing Year	Instrument manufacturing year.
Calibration	Date of the last instrument calibration (dd/mm/yyyy).
Configuration	Instrument hardware configuration ID.
Version	Instrument software version.
Display Version	Instrument display software version.
IP Address	IP address used on the two Ethernet ports.
MAC Address	MAC address of the two Ethernet ports.
Internet	Internet connection status. OK=active connection, -=inactive connection
GPS Status	GPS signal status. OK=fixed, -=not available or no signal
Last Server Connection	Date and time of the last connection performed automatically towards FTP/SFTP server (yyyy/mm/dd hh:mm:ss).
Data Transfer Result	Result of the last automatic upload. OK=upload successful, ERR=upload failed
Memory	Percentage value of the available memory space (%).
Battery	Internal backup battery charging value and status.
Digital Inputs	Digital input status. ON=input closed, OFF=input opened
WiFi	WiFi connection status. OFF=WiFi disabled; Access Point=WiFi enabled and operational in access point mode, Connected=WiFi enabled in client mode with connection in progress
Last Restart	Date and time of the last instrument power on/reboot (dd/mm/yyyy hh:mm:ss).

8.7. Settings



In this section the instrument settings can be accessed.

Select the setting type to be managed by clicking on **Setup** (General, Thresholds, Min/Avg/Max, Energy LOG, COM, Digital Inputs, Analog Outputs, Digital Outputs).

8.7.1. General

This section allows to display and change the general and measurement settings as well as set the custom page. According to the selected sub-menu, the corresponding settings will be displayed.

GENERAL

In this page, general instrument setup can be modified.

Real Time	Harmonics	Graphics	Recordings	Status	Setup	Administration
GENERAL MEASUREMENTS SETUP						
General		Measurements	Custom Page			
Parameter	Setup	Description				
Device Name	DIRISQ800	Device's identification name				
Timezone's Region	Europe	Region's name of the system timezone				
Timezone's City	[+01:00] Paris	City's name of the system timezone				
RTC Sync	Auto	RTC date and time synchronization mode				
RTC Date	26/07/2016	Manual date setup or synced date				
RTC Hour	09:44:45	Manual hour setup or synced hour				

Device Name	Instrument name/ID (max 16 alphanumeric characters) used for identification in recording files. Do not use character “_” for the name/ID.
Timezone's Region	World Region for UTC time correction.
Timezone's City	City for UTC time correction.
RTC Sync	Date and time synchronisation. Available choices: <ul style="list-style-type: none"> • Disable=synchronisation disabled, date and time must be set manually • NTP=synchronisation by NTP server (Internet connection required) • GPS=synchronisation by GPS • Auto=synchronisation by GPS/NTP: GPS priority. Everytime the GPS signal is missing, the instrument synchronisation is automatically switched on NTP (Internet connection required).
RTC Date	Date in real time (dd/mm/yyyy). If RTC synchronisation is enabled, this field cannot be modified. If RTC synchronisation is disabled, this field is programmable by entering date manually.
RTC Hour	Hour in real time (hh:mm:ss). If RTC synchronisation is enabled, this field cannot be modified. If RTC synchronisation is disabled, this field is programmable by entering hour manually.

 Note: the DST (Daylight Saving Time) function is available according to the set timezone (refer to section “7.5. Internal clock synchronisation”, page 31).

 **WARNING!** To guarantee the real time clock synchronisation the parameter Auto is suggested.

MEASUREMENTS

The available parameters change according to the instrument model.

Real Time	Harmonics	Graphics	Recordings	Status	Setup	Administration
GENERAL MEASUREMENTS SETUP						
General		Measurements	Custom Page			
Parameter	Setup	Description				
3-Phase Wiring	3phase-4wires <input type="checkbox"/>	Three phase input wiring configuration				
3-Phase PT Primary	1	PT primary full-scale value [V] (set 1 for Dirrect connection)				
3-Phase PT Secondary	1	PT secondary full-scale value [V] (set 1 for Dirrect connection)				
3-Phase Nominal Value	230.00	System nominal voltage [V]				
U4N PT Primary	1	U4N PT primary full-scale value [V]				
U4N PT Secondary	1	U4N PT secondary full-scale value [V]				
U4N Input Nominal Value	230.00	U4N input nominal voltage [V]				
3P&I4 CT Primary	5	3 Phase & I4 external CT primary full-scale value [A]				
3P&I4 CT Secondary	5A <input type="checkbox"/>	3 Phase & I4 external CT secondary full-scale value [A]				
I5 CT Primary	5	I5 External CT primary full-scale value [A]				
I5 CT Secondary	5A <input type="checkbox"/>	I5 External CT secondary full-scale value [A]				
System Frequency	50 <input type="checkbox"/>	System frequency nominal value [Hz]				
Integration time	10	Frequency computation integration period [s]				

3-Phase Wiring	<p>Wiring mode. Available choices:</p> <ul style="list-style-type: none"> • 3P-4W-4C (4NBL)=3 phases, 4 wires, 4 currents • 3P-4W-3C (4NBL)=3 phases, 4 wires, 3 currents • 3P-3W-3C (3NBL)=3 phases, 3 wires, 3 currents • 3P-3W-2C (3NBL)=3 phases, 3 wires, 2 currents • 2P-3W-3C (2NBL)=2 phases, 3 wires, 3 currents • 1P-2W-1C (1BL)=1 phase, 2 wires, 1 current
3-Phase PT Primary	3 or 1 phase voltage primary value for inductive PT. Range: 1...999999 V. In case of 3-3-3 or 3-3-2 wiring, the primary value represents the line voltage (VLL). For direct connection, set 1 both for 3-Phase PT primary and secondary.
3-Phase PT Secondary	3 or 1 phase voltage secondary value for inductive PT. Range: 1...999 V. In case of 3-3-3 or 3-3-2 wiring, the secondary value represents the line voltage (VLL). For direct connection, set 1 both for 3-Phase PT primary and secondary.
3-Phase Nominal Value	3 or 1 phase voltage nominal value. This is a phase-to-neutral value (VLN) for 4 or 2 wire insertion, or a phase-to-phase value (VLL) for 3 wire insertion. All 3phase/1phase voltage thresholds are referred to this value. This value must be set as primary value in case of inductive PT. Range: 1...999999 V
U4N PT Primary	4th voltage primary value for inductive PT. Range: 1...999999 V. For direct connection, set 1 both for U4 PT primary and secondary.
U4N PT Secondary	4th voltage secondary value for inductive PT. Range: 1...999 V. For direct connection, set 1 both for U4 PT primary and secondary.
U4N Input Nominal Value	4th voltage nominal value. All 4th voltage thresholds are referred to this value. Range: 1...999999 V
System Frequency	System frequency nominal value. All frequency thresholds are referred to this value. Available choices: 50 or 60 Hz
Integration Time	Integration time for frequency calculation. Range: 1...10 s
3P&I4 CT Primary	CT primary full scale value for I1, I2, I3 and I4 inputs. Range: 1...999999 A.
3P&I4 CT Secondary	CT secondary full scale value for I1, I2, I3 and I4 inputs. Available choices: 1 or 5 A.

I5 CT Primary	CT primary full scale value for I5 input. Range: 1...999999 A.
I5 CT Secondary	CT secondary full scale value for I5 input. Available choices: 1 or 5 A.
Harmonics	Display mode of harmonic values; this setting has effect both on display, web server and MODBUS protocol. Available choices: Absolute or Percentage.



WARNING! If some settings change, the recordings will be restarted and saved in a new file.

DEMAND

In this page, demand calculation setup and display limits can be modified.

Real Time	Harmonics	Graphics	Recordings	Status	Setup	Administration
-----------	-----------	----------	------------	--------	-------	----------------

GENERAL MEASUREMENTS SETUP ✕ ✓

General Measurements **Demand** Custom Page

Parameter	Setup	Description
Mode	Rolling ▾	Demand calculation mode
Period	1	Demand integration period [min]
Subperiod	15	Rolling mode subperiod [min]
PΣDMD Limit	8000	Active power daily demand graphic limit [W]
QΣDMD Limit	6000	Reactive power daily demand graphic limit [var]
SΣDMD Limit	10000	Apparent power daily demand graphic limit [VA]

Demand Mode

Mode for demand value calculation. Available choices:

Fixed=the demand value is calculated at the end of the Demand period (fixed window).

Sliding=the demand value is calculated each second if the set Demand period is lower or equal than 5 minutes. Otherwise, the demand value is calculated each minute if the set Demand period is higher than 5 minutes (sliding window).

Rolling=the demand value is calculated on the fixed period and it is refreshed according to the set Subperiod. By selecting this mode, an additional field, Subperiod, will be shown (rolling window).

Demand Period

Rate for demand value calculation and recording. Range: 1...60 min.

Subperiod

Available only when Demand Mode=Rolling. Refreshing rate for demand value calculation. To set this value, consider that the Subperiod must be a submultiple of the Demand period.

PΣDMD Limit

Limit of system active power demand shown on demand daily graphic page.

QΣDMD Limit

Limit of system reactive power demand shown on demand daily graphic page.

SΣDMD Limit

Limit of system apparent power demand shown on demand daily graphic page.



WARNING! If the Demand Mode, Demand Period or Subperiod is modified, the instrument will reset the Demand, Demand MAX values, restart the Demand Period and start a new LOG file.

CUSTOM PAGE

In this page, the custom real time page parameter selection can be performed.

Real Time	Harmonics	Graphics	Recordings	Status	Setup	Administration
-----------	-----------	----------	------------	--------	-------	----------------

GENERAL MEASUREMENTS SETUP ⚙️

General
Measurements
Custom Page

Position	Parameter
Column1, Row1	U1N <input type="text" value="v"/>
Column1, Row2	U2N <input type="text" value="v"/>
Column1, Row3	U3N <input type="text" value="v"/>
Column1, Row4	F <input type="text" value="v"/>

Position	Parameter
Column2, Row1	U12 <input type="text" value="v"/>
Column2, Row2	U23 <input type="text" value="v"/>
Column2, Row3	U31 <input type="text" value="v"/>
Column2, Row4	Ph <input type="text" value="v"/>

Position	Indication of the parameter position inside the Custom page grid.
Parameter	Real time parameter selection to be displayed on Custom page.

8.7.2. Thresholds

This section allows to display and change the measurement thresholds for event detection. According to the selected sub-menu, the corresponding thresholds will be displayed.

GENERAL

In this page, the general recording parameters can be modified.

Real Time	Harmonics	Graphics	Recordings	Status	Setup	Administration
-----------	-----------	----------	------------	--------	-------	----------------

RECORDINGS THRESHOLDS SETUP ⚙️

General
Fast Voltage
Other U-f-I
Mains Signalling

Parameter	Setup	Description
General	<input type="checkbox"/> Dis <input checked="" type="checkbox"/> En	Triggered recordings general enable
Hysteresis	1.0	Fast voltage events thresholds hysteresis (%Un)
Event In Pre-Trigger	50	Number of cycles recorded before the event start trigger
Event In Post-Trigger	100	Number of cycles recorded after the event start trigger
Event Out Pre-Trigger	50	Number of cycles recorded before the event end trigger
Event Out Post-Trigger	50	Number of cycles recorded after the event end trigger

General	General enable / disable all event recordings.
Hysteresis	Threshold hysteresis for fast voltage event detection, referred to the nominal voltage value. Range: 1,0...25,0%
Event In Pre-Trigger	Wave number to be captured at event entry, before threshold exceeding. Range: 1...50
Event In Post-Trigger	Wave number to be captured at event entry, after threshold exceeding. Range: 1...3000
Event Out Pre-Trigger	Wave number to be captured at event exit, just before variation ending. Range: 1...50
Event Out Post-Trigger	Wave number to be captured at event exit, after variation ending. Range: 1...50

FAST VOLTAGE

The Threshold field shows the threshold available for event detection. For each threshold it is possible to set the percentage value (Value %) and to enable (En) or disable it (Dis). The absolute value (Absolute, not programmable) is calculated on the percentage value automatically, considering the nominal values set in Setup>General>Measurement (refer to section “8.7.1. General”, page 80).

Real Time	Harmonics	Graphics	Recordings	Status	Setup	Administration
RECORDINGS THRESHOLDS SETUP						
General	Fast Voltage	Other U-f-I	Mains Signalling			
Threshold	Value [%]	Absolute	Setup		Description	
Voltage Swells	<input type="text" value="110.0"/>	<input type="text" value="253.0"/>	<input type="button" value="Dis"/>	<input type="button" value="En"/>	Fast voltage variations high threshold (%Un)	
Voltage Sags	<input type="text" value="90.0"/>	<input type="text" value="207.0"/>	<input type="button" value="Dis"/>	<input type="button" value="En"/>	Fast voltage variations low threshold (%Un)	
Voltage Interruptions	<input type="text" value="5.0"/>	<input type="text" value="11.5"/>	<input type="button" value="Dis"/>	<input type="button" value="En"/>	Fast voltage variations interruption threshold (%Un)	
Currents			<input type="button" value="Dis"/>	<input type="button" value="En"/>	Record current channels during fast voltage events	
Transient Level		<input type="text" value="150.0"/>	<input type="button" value="Dis"/>	<input type="button" value="En"/>	Fast voltage transient level (V)	
Transient Duration		<input type="text" value="20"/>			Fast voltage transient duration (us)	
RVC Threshold	<input type="text" value="4.0"/>	<input type="text" value="9.2"/>	<input type="button" value="Dis"/>	<input type="button" value="En"/>	Rapid voltage changes threshold (%Un)	
RVC Hysteresis	<input type="text" value="50.0"/>	<input type="text" value="4.60"/>			Rapid voltage changes hysteresis (% RVC Threshold)	
U4N High	<input type="text" value="0.0"/>	<input type="text" value="0.0"/>	<input type="button" value="Dis"/>	<input type="button" value="En"/>	U4N voltage input high threshold (%U4n)	
U4N Low	<input type="text" value="0.0"/>	<input type="text" value="0.0"/>	<input type="button" value="Dis"/>	<input type="button" value="En"/>	U4N voltage input low threshold (%U4n)	

Voltage Swells	High threshold for fast voltage events, referred to the nominal voltage value. Range: 1.0...200.0%
Voltage Sags	Low threshold for fast voltage events, referred to the nominal voltage value. Range: 1.0...100.0%
Voltage Interruptions	Interruption threshold for fast voltage events, referred to the nominal voltage value. Range: 1.0...100.0%
Currents	Enable the recording of the current channels (I1, I2, I3) during fast voltage events
Transient Level	Absolute level threshold for voltage transient events. Range: 10.0...500.0 V
Transient Duration	Duration threshold for voltage transient events. Range: 20...100 us @ 50Hz; 30...150 us @ 60Hz
RVC Threshold	Threshold for rapid voltage changes, referred to the nominal voltage value. Range: 1.0...25.0%
RVC Hysteresis	Hysteresis for rapid voltage changes, referred to the set RVC threshold. In steady state condition the RVC hysteresis is not considered. Range: 0.1...99.0%
U4 High	High threshold for fast 4th voltage events, referred to the nominal 4th voltage value. Range: 1.0...200.0%
U4 Low	Low threshold for fast 4th voltage events, referred to the nominal 4th voltage value. Range: 1.0...100.0%

Note:

- according to the set threshold percentage value, the absolute value will be shown only after setup confirmation.
- the settings about wave number are common for all the fast events. Therefore, the fast events will generate the same raw data quantity (in PQDIF files).

POP-UP ALARM FOR SLOW FREQUENCY EVENTS

After enabling the slow frequency thresholds, a pop-up window is displayed when new slow frequency events are detected. This pop-up window shows the number of new events and details about the last event. For more details, refer to the following description:

New events	Number of new detected events. By closing the pop-up window, this number will restart at the next event detection. If the pop-up window is not closed, this number will increase at the next event detection.
Last Slow Freq...	Last event start date and time with 10 ms accuracy (dd/mm/yyyy hh:mm:ss,cc).
Type	Last event type.
Value	Extreme frequency value detected during the last event (Hz).
Duration	Last event length with 10 ms accuracy (hh:mm:ss,cc).
Go to event list button	Show the Slow frequency event list.

Note:

This alarm pop-up window is not shown if the currently displayed page is:



- Setup
- Administration
- Slow event list

OTHER U-F-I

The Threshold field shows all the threshold available for event detection. For each threshold, except for Flicker, it is possible to set the percentage value (Value %) and to enable (En) or disable it (Dis). The absolute value (Absolute, not programmable) is calculated on the percentage value automatically, considering the nominal values set in Setup>General>Measurement (refer to section "8.7.1. General", page 80).

Real Time	Harmonics	Graphics	Recordings	Status	Setup	Administration
RECORDINGS THRESHOLDS SETUP						
General	Fast Voltage	Other U-f-i	Mains Signalling			
Threshold	Value [%]	Absolute	Setup		Description	
Slow Voltage High	<input type="text" value="110.0"/>	<input type="text" value="253.0"/>	<input type="button" value="Dis"/>	<input type="button" value="En"/>	Slow voltage changes high threshold (%Un)	
Slow Voltage Low	<input type="text" value="90.0"/>	<input type="text" value="207.0"/>	<input type="button" value="Dis"/>	<input type="button" value="En"/>	Slow voltage changes low threshold (%Un)	
Fast Freq. High	<input type="text" value="102.0"/>	<input type="text" value="51.0"/>	<input type="button" value="Dis"/>	<input type="button" value="En"/>	Fast Frequency (1c) high threshold (%fn)	
Fast Freq. Low	<input type="text" value="98.0"/>	<input type="text" value="49.0"/>	<input type="button" value="Dis"/>	<input type="button" value="En"/>	Fast Frequency (1c) low threshold (%fn)	
Slow Freq. High	<input type="text" value="102.0"/>	<input type="text" value="51.0"/>	<input type="button" value="Dis"/>	<input type="button" value="En"/>	Slow Frequency (AVG) high threshold (%fn)	
Slow Freq. Low	<input type="text" value="98.0"/>	<input type="text" value="49.0"/>	<input type="button" value="Dis"/>	<input type="button" value="En"/>	Slow Frequency (AVG) low threshold (%fn)	
Unbal. Neg. Seq. High	<input type="text" value="2.0"/>		<input type="button" value="Dis"/>	<input type="button" value="En"/>	Negative unbalance ratio high threshold - u2 (%)	
Unb. Zero Seq. High	<input type="text" value="2.0"/>		<input type="button" value="Dis"/>	<input type="button" value="En"/>	Zero unbalance ratio high threshold - u0 (%)	
Flicker Plt High	<input type="text" value="1.0"/>		<input type="button" value="Dis"/>	<input type="button" value="En"/>	Flicker Plt high threshold	
Voltage THD High	<input type="text" value="8.0"/>		<input type="button" value="Dis"/>	<input type="button" value="En"/>	Supply voltage THD high threshold (%)	
Currents High	<input type="text" value="0.0"/>	<input type="text" value="0.0"/>	<input type="button" value="Dis"/>	<input type="button" value="En"/>	Fast overcurrent high threshold (%FSA)	

Slow Voltage High	High threshold for slow voltage events, referred to the nominal voltage value. Range: 1.0...200.0%
Slow Voltage Low	Low threshold for slow voltage events, referred to the nominal voltage value. Range: 1.0...100.0%
Fast Freq. High	High threshold for fast frequency events, referred to the nominal frequency value. Range: 1.0...200.0%
Fast Freq. Low	Slow threshold for fast frequency events, referred to the nominal frequency value. Range: 1.0...100.0%
Unbal. Neg. Seq. High	High threshold for voltage negative unbalance ratio events. Range: 1.0...100.0%
Unbal. Zero Seq. High	High threshold for voltage zero unbalance ratio events. Range: 1.0...100.0%
Flicker Plt High	High threshold for flicker events. Range: 1.0...100.0
Voltage THD High	High threshold for voltage THD events. Range: 1.0...250.0%
Currents High	High threshold for fast current events, referred to the current full scale value. Range: 1.0...200.0%

Note:

- according to the set threshold percentage value, the absolute value will be shown only after setup confirmation.
- the settings about wave number are common for all the fast events. Therefore, the fast events will generate the same raw data quantity (in PQDIF files).

MAINS SIGNALLING

In this page, the Mains Signalling parameters can be set.

Real Time	Harmonics	Graphics	Recordings	Status	Setup	Administration
-----------	-----------	----------	------------	--------	-------	----------------

RECORDINGS THRESHOLDS SETUP

General Fast Voltage Other U-f-I **Mains Signalling**

Parameter	Setup	Description
Threshold	<input type="text" value="15.0"/>	Monitoring Threshold (%Un)
MAX Period	<input type="text" value="120"/>	Maximum value monitoring period (s)
Mains Signalling 1	<input type="text" value="0.00"/>	Monitoring Frequency 1 (Hz)
Mains Signalling 2	<input type="text" value="0.00"/>	Monitoring Frequency 2 (Hz)
Mains Signalling 3	<input type="text" value="0.00"/>	Monitoring Frequency 3 (Hz)
Mains Signalling 4	<input type="text" value="0.00"/>	Monitoring Frequency 4 (Hz)
Mains Signalling 5	<input type="text" value="0.00"/>	Monitoring Frequency 5 (Hz)
Display	<input type="text" value="10/12c"/> <input type="button" value="v"/>	Type of Mains Signalling display on Real Time page
Recording	<input type="button" value="Dis"/> <input type="button" value="En"/>	Mains Signalling events recording

Threshold Threshold for Mains Signalling, referred to the nominal voltage value. Range: 0.1...100.0%

MAX Period Mains Signalling maximum value monitoring period. Range: 1...120 s

Mains Signalling 1 Monitoring frequency 1. Range: 0.01...3000.00 Hz

Mains Signalling 2 Monitoring frequency 2. Range: 0.01...3000.00 Hz

Mains Signalling 3 Monitoring frequency 3. Range: 0.01...3000.00 Hz

Mains Signalling 4 Monitoring frequency 4. Range: 0.01...3000.00 Hz

Mains Signalling 5 Monitoring frequency 5. Range: 0.01...3000.00 Hz

Display Mains Signalling value type displayed on Real Time page. Available choices: Max=maximum value detected on the set period, 10/12c.

Recording Enable / disable the Mains Signalling event recording according to EN 50160.

8.7.3. Min/Avg/Max

This section allows to display and change the settings for Min/Avg/Max recording. According to the selected sub-menu, the corresponding recording parameters will be displayed.

To start a Min/Avg/Max recording:

1. Enable the parameters to be recorded in *Voltages, Currents, Deviations, Flickers, Powers, Power Fact., Harmonics, Signallings, Other* sub-menus.
2. In *General*, set the recording rate and finally enable the recording.
3. The instrument will start to record at the set rate the Min/Avg/Max values of the selected parameters.

Note:



- the maximum size for a Min/Avg/Max file is 10 MB. When the file maximum size is reached, a new file is generated automatically.
- some parameters may not be available according to the set wiring mode.

GENERAL

In this page the general settings can be carried out for Min/Avg/Max recording.

Real Time	Harmonics	Graphics	Recordings	Status	Setup	Administration			
MIN/AVG/MAX RECORDINGS SETUP									
General	Voltages	Currents	Deviations	Flickers	Powers	Power Fact.	Harmonics	Signallings	Other
Parameter	Status		Description						
General	Dis	En	General min/Avg/MAX recordings enable						
Rate	900		Integration period used in min/Avg/MAX recording [s]						

General General enable / disable all Min/Avg/Max recording.

Rate Rate for Min/Avg/Max value calculation and recording. Range: 1...3600 s

VOLTAGES

In this page the voltage parameters can be enabled for Min/Avg/Max recording.

Real Time	Harmonics	Graphics	Recordings	Status	Setup	Administration			
MIN/AVG/MAX RECORDINGS SETUP									
General	Voltages	Currents	Deviations	Flickers	Powers	Power Fact.	Harmonics	Signallings	Other
Parameter	Status		Description						
U1N/U12	<input type="checkbox"/> Dis	<input type="checkbox"/> En	U1N voltage for 4 wires system or single-phase, and/or U12 line voltage						
U2N/U23	<input type="checkbox"/> Dis	<input type="checkbox"/> En	U2N voltage for 4 wires system, and/or U23 line voltage						
U3N/U31	<input type="checkbox"/> Dis	<input type="checkbox"/> En	U3N voltage for 4 wires system, and/or U31 line voltage						
UΣ	<input type="checkbox"/> Dis	<input type="checkbox"/> En	System voltage for 4 or 3 wires system						
U4N	<input type="checkbox"/> Dis	<input type="checkbox"/> En	Line 4 to Neutral Voltage						
U41	<input type="checkbox"/> Dis	<input type="checkbox"/> En	Line 4 to Phase 1 Voltage						
U42	<input type="checkbox"/> Dis	<input type="checkbox"/> En	Line 4 to Phase 2 Voltage						
U43	<input type="checkbox"/> Dis	<input type="checkbox"/> En	Line 4 to Phase 3 Voltage						
THD U1N/U12	<input type="checkbox"/> Dis	<input type="checkbox"/> En	THD for U1N voltage for 4 wires system or single-phase, and/or U12 line voltage						
THD V2N/V23	<input type="checkbox"/> Dis	<input type="checkbox"/> En	THD for V2N voltage for 4 wires system, and/or V23 line voltage						
THD V3N/V31	<input type="checkbox"/> Dis	<input type="checkbox"/> En	THD for V3N voltage for 4 wires system, and/or V31 line voltage						

CURRENTS

In this page the current parameters can be enabled for Min/Avg/Max recording.

Real Time	Harmonics	Graphics	Recordings	Status	Setup	Administration			
MIN/AVG/MAX RECORDINGS SETUP									
General	Voltages	Currents	Deviations	Flickers	Powers	Power Fact.	Harmonics	Signallings	Other
Parameter	Status		Description						
I1	<input type="checkbox"/> Dis	<input type="checkbox"/> En	Phase 1 current						
I2	<input type="checkbox"/> Dis	<input type="checkbox"/> En	Phase 2 current						
I3	<input type="checkbox"/> Dis	<input type="checkbox"/> En	Phase 3 current						
IΣ	<input type="checkbox"/> Dis	<input type="checkbox"/> En	System current						
I4	<input type="checkbox"/> Dis	<input type="checkbox"/> En	Phase 4 current						
I5	<input type="checkbox"/> Dis	<input type="checkbox"/> En	Phase 5 current						
I1 THD	<input type="checkbox"/> Dis	<input type="checkbox"/> En	THD of phase 1 current						
I2 THD	<input type="checkbox"/> Dis	<input type="checkbox"/> En	THD of phase 2 current						
I3 THD	<input type="checkbox"/> Dis	<input type="checkbox"/> En	THD of phase 3 current						
K1	<input type="checkbox"/> Dis	<input type="checkbox"/> En	Phase 1 K Factor						
K2	<input type="checkbox"/> Dis	<input type="checkbox"/> En	Phase 2 K Factor						
K3	<input type="checkbox"/> Dis	<input type="checkbox"/> En	Phase 3 K Factor						

DEVIATIONS

In this page the deviation parameters can be enabled for Min/Avg/Max recording.

Real Time	Harmonics	Graphics	Recordings	Status	Setup	Administration			
MIN/AVG/MAX RECORDINGS SETUP									
General	Voltages	Currents	Deviations	Flickers	Powers	Power Fact.	Harmonics	Signallings	Other
Parameter	Status		Description						
Udev U1N	<input type="checkbox"/> Dis	<input type="checkbox"/> En	Phase 1 to Neutral Voltage Underdeviation						
Udev U2N	<input type="checkbox"/> Dis	<input type="checkbox"/> En	Phase 2 to Neutral Voltage Underdeviation						
Udev U3N	<input type="checkbox"/> Dis	<input type="checkbox"/> En	Phase 3 to Neutral Voltage Underdeviation						
Udev U12	<input type="checkbox"/> Dis	<input type="checkbox"/> En	Line 1 to 2 Voltage Underdeviation						
Udev U23	<input type="checkbox"/> Dis	<input type="checkbox"/> En	Line 2 to 3 Voltage Underdeviation						
Udev U31	<input type="checkbox"/> Dis	<input type="checkbox"/> En	Line 3 to 1 Voltage Underdeviation						
Odev U1N	<input type="checkbox"/> Dis	<input type="checkbox"/> En	Phase 1 to Neutral Voltage Overdeviation						
Odev U2N	<input type="checkbox"/> Dis	<input type="checkbox"/> En	Phase 2 to Neutral Voltage Overdeviation						
Odev U3N	<input type="checkbox"/> Dis	<input type="checkbox"/> En	Phase 3 to Neutral Voltage Overdeviation						
Odev U12	<input type="checkbox"/> Dis	<input type="checkbox"/> En	Line 1 to 2 Voltage Overdeviation						
Odev U23	<input type="checkbox"/> Dis	<input type="checkbox"/> En	Line 2 to 3 Voltage Overdeviation						
Odev U31	<input type="checkbox"/> Dis	<input type="checkbox"/> En	Line 3 to 1 Voltage Overdeviation						

FLICKERS

In this page the Plt and Pst flicker parameters can be enabled for Min/Avg/Max recording.

Real Time	Harmonics	Graphics	Recordings	Status	Setup	Administration			
MIN/AVG/MAX RECORDINGS SETUP									
General	Voltages	Currents	Deviations	Flickers	Powers	Power Fact.	Harmonics	Signallings	Other
Parameter	Status		Description						
Pst1	<input type="checkbox"/> Dis	<input type="checkbox"/> En	Phase/line 1 Pst flicker						
Pst2	<input type="checkbox"/> Dis	<input type="checkbox"/> En	Phase/line 2 Pst flicker						
Pst3	<input type="checkbox"/> Dis	<input type="checkbox"/> En	Phase/line 3 Pst flicker						
Plt1	<input type="checkbox"/> Dis	<input type="checkbox"/> En	Phase/line 1 Plt flicker						
Plt2	<input type="checkbox"/> Dis	<input type="checkbox"/> En	Phase/line 2 Plt flicker						
Plt3	<input type="checkbox"/> Dis	<input type="checkbox"/> En	Phase/line 3 Plt flicker						

POWERS

In this page the active, reactive and apparent power parameters can be enabled for Min/Avg/Max recording.

Real Time	Harmonics	Graphics	Recordings	Status	Setup	Administration			
MIN/AVG/MAX RECORDINGS SETUP									
General	Voltages	Currents	Deviations	Flickers	Powers	Power Fact.	Harmonics	Signallings	Other
Parameter	Status		Description						
P1	<input type="checkbox"/> Dis	<input type="checkbox"/> En	Phase 1 active power for 4 wires system and single-phase connection						
P2	<input type="checkbox"/> Dis	<input type="checkbox"/> En	Phase 2 active power for 4 wires system						
P3	<input type="checkbox"/> Dis	<input type="checkbox"/> En	Phase 3 active power for 4 wires system						
PΣ	<input type="checkbox"/> Dis	<input type="checkbox"/> En	System active power						
Q1	<input type="checkbox"/> Dis	<input type="checkbox"/> En	Phase 1 reactive power for 4 wires system and single-phase connection						
Q2	<input type="checkbox"/> Dis	<input type="checkbox"/> En	Phase 2 reactive power for 4 wires system						
Q3	<input type="checkbox"/> Dis	<input type="checkbox"/> En	Phase 3 reactive power for 4 wires system						
QΣ	<input type="checkbox"/> Dis	<input type="checkbox"/> En	System reactive power						
S1	<input type="checkbox"/> Dis	<input type="checkbox"/> En	Phase 1 apparent power for 4 wires system and single-phase connection						
S2	<input type="checkbox"/> Dis	<input type="checkbox"/> En	Phase 2 apparent power for 4 wires system						
S3	<input type="checkbox"/> Dis	<input type="checkbox"/> En	Phase 3 apparent power for 4 wires system						
SΣ	<input type="checkbox"/> Dis	<input type="checkbox"/> En	System Apparent Power (SΣ)						

POWER FACTOR

In this page the TPF and DPF parameters can be enabled for Min/Avg/Max recording.

Real Time	Harmonics	Graphics	Recordings	Status	Setup	Administration		
MIN/AVG/MAX RECORDINGS SETUP								
General	Voltages	Currents	Deviations	Flickers	Power Fact.	Harmonics	Signallings	Other
Parameter	Status		Description					
TPF1	<input type="checkbox"/> Dis	<input type="checkbox"/> En	Phase 1 true power factor					
TPF2	<input type="checkbox"/> Dis	<input type="checkbox"/> En	Phase 2 true power factor					
TPF3	<input type="checkbox"/> Dis	<input type="checkbox"/> En	Phase 3 true power factor					
TPFΣ	<input type="checkbox"/> Dis	<input type="checkbox"/> En	System true power factor					
DPF1	<input type="checkbox"/> Dis	<input type="checkbox"/> En	Phase 1 displacement power factor					
DPF2	<input type="checkbox"/> Dis	<input type="checkbox"/> En	Phase 2 displacement power factor					
DPF3	<input type="checkbox"/> Dis	<input type="checkbox"/> En	Phase 3 displacement power factor					

HARMONICS

In this page the voltage and current harmonic and interharmonic groups can be enabled for Min/Avg/Max recording.

Real Time	Harmonics	Graphics	Recordings	Status	Setup	Administration			
MIN/AVG/MAX RECORDINGS SETUP									
General	Voltages	Currents	Deviations	Flickers	Powers	Power Fact.	Harmonics	Signalings	Other
Parameter	Status	Description							
Ha U1N	None <input type="button" value="v"/>	U1N voltage Harmonics and Interharmonics							
Ha U2N	None <input type="button" value="v"/>	U2N voltage Harmonics and Interharmonics							
Ha U3N	None <input type="button" value="v"/>	U3N voltage Harmonics and Interharmonics							
Ha U12	None <input type="button" value="v"/>	U12 voltage Harmonics and Interharmonics							
Ha U23	None <input type="button" value="v"/>	U23 voltage Harmonics and Interharmonics							
Ha U31	None <input type="button" value="v"/>	U31 voltage Harmonics and Interharmonics							
Ha I1	None <input type="button" value="v"/>	Phase 1 current Harmonics and Interharmonics							
Ha I2	None <input type="button" value="v"/>	Phase 2 current Harmonics and Interharmonics							
Ha I3	None <input type="button" value="v"/>	Phase 3 current Harmonics and Interharmonics							

For each parameter, select the harmonic group to be enabled (Group ...) or disabled (None). To enable all harmonics select Group 0.

Each group indicates a range of harmonics and/or corresponding interharmonics according to the set system frequency (50 or 60 Hz). Refer to the following table:

	50 Hz system frequency	60 Hz system frequency
Group 0	All main harmonics (NO interharmonics)	All main harmonics (NO interharmonics)
Group 1	DC ... 4th harmonics+interharmonics	DC ... 3rd harmonics+interharmonics
Group 2	5th ... 9th harmonics+interharmonics	4th ... 7th harmonics+interharmonics
Group 3	10th ... 14th harmonics+interharmonics	8th ... 11th harmonics+interharmonics
Group 4	15th ... 19th harmonics+interharmonics	12th ... 15th harmonics+interharmonics
Group 5	20th ... 24th harmonics+interharmonics	16th ... 19th harmonics+interharmonics
Group 6	25th ... 29th harmonics+interharmonics	20th ... 23rd harmonics+interharmonics
Group 7	30th ... 34th harmonics+interharmonics	24th ... 27th harmonics+interharmonics
Group 8	35th ... 39th harmonics+interharmonics	28th ... 31st harmonics+interharmonics
Group 9	40th ... 44th harmonics+interharmonics	32th ... 35th harmonics+interharmonics
Group 10	45th ... 50th harmonics+interharmonics	36th ... 39th harmonics+interharmonics
Group 11	51th ... 56th harmonics+interharmonics	40th ... 43rd harmonics+interharmonics
Group 12	57th ... 62th harmonics+interharmonics	44th ... 47th harmonics+interharmonics
Group 13	63th harmonics+interharmonics	48th ... 50th harmonics+interharmonics
Group 14	-	51th ... 50th harmonics+interharmonics
Group 15	-	54th ... 56th harmonics+interharmonics
Group 16	-	57th ... 59th harmonics+interharmonics
Group 17	-	60th ... 62th harmonics+interharmonics
Group 18	-	63th harmonics+interharmonics

SIGNALLINGS

In this page the mains signalling parameters can be enabled for Min/Avg/Max recording.

Real Time	Harmonics	Graphics	Recordings	Status	Setup	Administration			
MIN/AVG/MAX RECORDINGS SETUP									
General	Voltages	Currents	Deviations	Flickers	Powers	Power Fact.	Harmonics	Signallings	Other
Parameter	Status		Description						
MS1 U1N	<input type="checkbox"/> Dis	<input type="checkbox"/> En	Phase 1 to Neutral Mains Signalling 1						
MS1 U2N	<input type="checkbox"/> Dis	<input type="checkbox"/> En	Phase 2 to Neutral Mains Signalling 1						
MS1 U3N	<input type="checkbox"/> Dis	<input type="checkbox"/> En	Phase 3 to Neutral Mains Signalling 1						
MS2 U1N	<input type="checkbox"/> Dis	<input type="checkbox"/> En	Phase 1 to Neutral Mains Signalling 2						
MS2 U2N	<input type="checkbox"/> Dis	<input type="checkbox"/> En	Phase 2 to Neutral Mains Signalling 2						
MS2 U3N	<input type="checkbox"/> Dis	<input type="checkbox"/> En	Phase 3 to Neutral Mains Signalling 2						
MS3 U1N	<input type="checkbox"/> Dis	<input type="checkbox"/> En	Phase 1 to Neutral Mains Signalling 3						
MS3 U2N	<input type="checkbox"/> Dis	<input type="checkbox"/> En	Phase 2 to Neutral Mains Signalling 3						
MS3 U3N	<input type="checkbox"/> Dis	<input type="checkbox"/> En	Phase 3 to Neutral Mains Signalling 3						
MS4 U1N	<input type="checkbox"/> Dis	<input type="checkbox"/> En	Phase 1 to Neutral Mains Signalling 4						

OTHER

In this page the voltage symmetrical components, unbalance ratio and frequency parameters can be enabled for Min/Avg/Max recording.

Real Time	Harmonics	Graphics	Recordings	Status	Setup	Administration			
MIN/AVG/MAX RECORDINGS SETUP									
General	Voltages	Currents	Deviations	Flickers	Powers	Power Fact.	Harmonics	Signallings	Other
Parameter	Status		Description						
U0	<input type="checkbox"/> Dis	<input type="checkbox"/> En	Zero sequence voltage						
U1	<input type="checkbox"/> Dis	<input type="checkbox"/> En	Positive sequence voltage						
U2	<input type="checkbox"/> Dis	<input type="checkbox"/> En	Negative sequence voltage						
u0	<input type="checkbox"/> Dis	<input type="checkbox"/> En	Zero sequence unbalance ratio						
u2	<input type="checkbox"/> Dis	<input type="checkbox"/> En	Negative unbalance sequence ratio						
I0	<input type="checkbox"/> Dis	<input type="checkbox"/> En	Zero Sequence Current						
I1 (+)	<input type="checkbox"/> Dis	<input type="checkbox"/> En	Positive Sequence Current						
I2 (-)	<input type="checkbox"/> Dis	<input type="checkbox"/> En	Negative Sequence Current						
i0	<input type="checkbox"/> Dis	<input type="checkbox"/> En	Current Zero Sequence Unbalance Ratio						
i2	<input type="checkbox"/> Dis	<input type="checkbox"/> En	Current Negative Sequence Unbalance Ratio						
f	<input type="checkbox"/> Dis	<input type="checkbox"/> En	Frequency						

8.7.4. Demand LOG

This section allows to display and change the settings for Demand LOG recording. According to the selected sub-menu, the corresponding recording parameters will be displayed.

To start a Demand LOG recording:

1. Enable the parameters to be recorded in Currents, ActivePow, ReactivePow, ApparentPow, TruePF submenus.
2. In General, enable the recording.
3. According to Demand Mode and Demand Period, the instrument will start to record the Demand values of the selected parameters.



Note: some parameters may not be available according to the set wiring mode.

GENERAL

In this page Demand LOG recording can be enabled/disabled.

Real Time	Harmonics	Graphics	Recordings	Status	Setup	Administration
DEMAND RECORDINGS SETUP						
General	Currents	Active Pow	Reactive Pow	Apparent Pow	True PF	
Parameter		Status		Description		
General		Dis	En	General demand recordings enable		

General Enable / disable Demand LOG recording.

CURRENTS

In this page the current parameters can be enabled for Demand LOG recording.

Real Time	Harmonics	Graphics	Recordings	Status	Setup	Administration
DEMAND RECORDINGS SETUP						
General	Currents	Active Pow	Reactive Pow	Apparent Pow	True PF	
Parameter		Status		Description		
I1DMD		Dis	En	Phase 1 Current Demand		
I2DMD		Dis	En	Phase 2 Current Demand		
I3DMD		Dis	En	Phase 3 Current Demand		
I4DMD		Dis	En	Line 4 (I4/IN) Current Demand		
IΣDMD		Dis	En	System Current Demand		
I5DMD		Dis	En	Phase 5 (IEL) Current Demand		

ACTIVE POWERS

In this page the active power parameters can be enabled for Demand LOG recording.

Real Time	Harmonics	Graphics	Recordings	Status	Setup	Administration
DEMAND RECORDINGS SETUP						
General	Currents	Active Pow	Reactive Pow	Apparent Pow	True PF	
Parameter	Status		Description			
+P1DMD	Dis	En	Phase 1 Positive Active Power Demand			
-P1DMD	Dis	En	Phase 1 Negative Active Power Demand			
+P2DMD	Dis	En	Phase 2 Positive Active Power Demand			
-P2DMD	Dis	En	Phase 2 Negative Active Power Demand			
+P3DMD	Dis	En	Phase 3 Positive Active Power Demand			
-P3DMD	Dis	En	Phase 3 Negative Active Power Demand			
+PΣDMD	Dis	En	System Positive Active Power Demand			
-PΣDMD	Dis	En	System Negative Active Power Demand			

REACTIVE POWERS

In this page the reactive power parameters can be enabled for Demand LOG recording.

Real Time	Harmonics	Graphics	Recordings	Status	Setup	Administration
DEMAND RECORDINGS SETUP						
General	Currents	Active Pow	Reactive Pow	Apparent Pow	True PF	
Parameter	Status		Description			
+Q1DMD	Dis	En	Phase 1 Positive Reactive Power Demand			
-Q1DMD	Dis	En	Phase 1 Negative Reactive Power Demand			
+Q2DMD	Dis	En	Phase 2 Positive Reactive Power Demand			
-Q2DMD	Dis	En	Phase 2 Negative Reactive Power Demand			
+Q3DMD	Dis	En	Phase 3 Positive Reactive Power Demand			
-Q3DMD	Dis	En	Phase 3 Negative Reactive Power Demand			
+QΣDMD	Dis	En	System Positive Reactive Power Demand			
-QΣDMD	Dis	En	System Negative Reactive Power Demand			

APPARENT POWERS

In this page the apparent power parameters can be enabled for Demand LOG recording.

Real Time	Harmonics	Graphics	Recordings	Status	Setup	Administration
DEMAND RECORDINGS SETUP						
General	Currents	Active Pow	Reactive Pow	Apparent Pow	True PF	
Parameter	Status		Description			
S1DMD	Dis	En	Phase 1 Apparent Power Demand			
S2DMD	Dis	En	Phase 2 Apparent Power Demand			
S3DMD	Dis	En	Phase 3 Apparent Power Demand			
SΣDMD	Dis	En	System Apparent Power Demand			

TRUE POWER FACTOR

In this page the true power factor parameters can be enabled for Demand LOG recording.

Real Time	Harmonics	Graphics	Recordings	Status	Setup	Administration
DEMAND RECORDINGS SETUP						
General	Currents	Active Pow	Reactive Pow	Apparent Pow	True PF	
Parameter	Status		Description			
+TPF1DMD	Dis	En	Phase 1 Positive True Power Factor Demand			
-TPF1DMD	Dis	En	Phase 1 Negative True Power Factor Demand			
+TPF2DMD	Dis	En	Phase 2 Positive True Power Factor Demand			
-TPF2DMD	Dis	En	Phase 2 Negative True Power Factor Demand			
+TPF3DMD	Dis	En	Phase 3 Positive True Power Factor Demand			
-TPF3DMD	Dis	En	Phase 3 Negative True Power Factor Demand			
+TPFΣDMD	Dis	En	System Positive True Power Factor Demand			
-TPFΣDMD	Dis	En	System Negative True Power Factor Demand			

8.7.5. Data LOG

This section allows to display and change the settings for Data LOG recording like Frequency LOG and Counter LOG.

To start a Frequency LOG recording, set the integration time in Setup>General>Measurements (refer to section 8.7.1) and finally enable the recording. The instrument will start to record the frequency at the set integration time.

To start a Counter LOG recording, set the recording rate and finally enable the recording. The instrument will start to record the energy counters at the set rate.

Note:



- the maximum size for a LOG file is 10 MB. When the file maximum size is reached, a new file is generated automatically.
- by enabling the Energy LOG, all energy counter value will be logged.

Real Time	Harmonics	Graphics	Recordings	Status	Setup	Administration
DATA LOG RECORDINGS SETUP						
Parameter		Setup		Description		
Frequency LOG	<input type="button" value="Dis"/>	<input type="button" value="En"/>	General Frequency LOG recordings enable			
Energy LOG	<input type="button" value="Dis"/>	<input type="button" value="En"/>	General Energy Counters recording enable			
Energy LOG Rate	<input type="text" value="1440"/>		Logging rate of energy counters [min]			

Frequency LOG Enable / disable Frequency LOG recording.

Energy LOG Enable / disable Counter LOG recording.

Energy LOG Rate Recording rate. Range: 1...1440 minutes

8.7.6. Communication

This section allows to display and change the settings for the instrument communication. According to the selected sub-menu, the corresponding communication parameters will be displayed.

NETWORK

In this page the instrument network parameters can be modified.

Real Time	Harmonics	Graphics	Recordings	Status	Setup	Administration
COMMUNICATION & DATA TRANSFER SETUP						
Network	FTP	Schedule	WiFi			
Parameter	Setup	Description				
IP Address	<input type="text" value="172.23.24.115"/>	IP address of front and rear LAN ports				
Netmask	<input type="text" value="255.255.0.0"/>	Instrument subnet mask				
Gateway IP Address	<input type="text" value="172.23.13.1"/>	IP address of gateway providing Internet access				
Primary DNS	<input type="text" value="8.8.8.8"/>	Primary DNS server address				
Secondary DNS	<input type="text" value="8.8.4.4"/>	Secondary DNS server address				
Primary NTP	<input type="text" value="172.23.50.105"/>	Primary NTP server address				
Secondary NTP	<input type="text"/>	Secondary NTP server address				
RS485 Baud Rate	<input type="text" value="38400"/> <input type="button" value="v"/>	Modbus RTU (8N1) RS485 port bitrate [bps]				
Modbus Address	<input type="text" value="1"/>	Modbus RTU slave address in 01-F7 range (HEX)				
Modbus TCP 2	<input type="text" value="503"/>	Modbus TCP 2 Port Number				
Modbus Over TCP	<input type="text" value="3000"/>	Modbus Over TCP Port Number				

IP Address	Static IP address common for both Ethernet ports (front and rear). For a local connection type this address in the web browser. For a remote connection by Internet/router, set this address in the router NAT rule.
Netmask	Instrument subnet mask.
Gateway IP Address	Gateway IP address for WAN access.
Primary DNS	Primary DNS server address, used to resolve NTP & FTP/SFTP server names.
Secondary DNS	Secondary DNS server address, used to resolve NTP & FTP/SFTP server names.
Primary NTP	Primary NTP server address used for RTC synchronisation (max 32 alphanumeric characters).
Secondary NTP	Secondary NTP server address used for RTC synchronisation if primary NTP is not reachable (max 32 alphanumeric characters).
RS485 Baud Rate	RS485 communication speed in Modbus RTU (8N1 format). Available choices: 4800, 9600, 19200, 38400, 57600, 115200 bps.
Modbus Address	Instrument Modbus address in hexadecimal format. Range: \$01...\$F7 (1...247).
Modbus TCP 2	Number of Modbus TCP 2 port. Range: 503...65535.
Modbus over TCP	Number of Modbus Over TCP port. Range: 503...65535.

- Note:
- the IP address for both instrument and gateway must have the same IP class.
 - the Modbus address is common for both Modbus RTU, Modbus TCP and Modbus Over TCP protocols.
 - before Hostname setup, make sure that the match between Hostname and IP address is registered in the network DNS server.
 - if DHCP mode is set but there is no DHCP server in the network, the instrument is always accessible to the static IP address.
 - up to 4 clients can be connected for each MODBUS port.

FTP

In this page the FTP/SFTP server parameters can be set for automatic uploading.

Real Time	Harmonics	Graphics	Recordings	Status	Setup	Administration
COMMUNICATION & DATA TRANSFER SETUP						
Network	FTP	Schedule	WiFi			
Parameter	Setup	Description				
Protocol	FTP <input type="button" value="v"/>	Protocol selection for remote upload (FTP/SFTP)				
Server Address	192.168.1.250	Remote server address used for data transfer				
Server User Name	user	Remote server access User Name				
Server Password	•••••	Remote server access Password				
Server Directory	directory	Remote server folder				

- Protocol** Enable/disable the automatic recording upload to a remote server. To enable it, select the protocol type, FTP or SFTP. Available choices: Disable, FTP, SFTP.
- Server Address** Remote server address for automatic data upload.
- Server User Name** Username for FTP or SFTP remote server access, to upload recordings (refer to section “7.11. Recording transfer”, page 50).
- Server Password** Password for FTP or SFTP remote server access, to upload recordings (refer to section “7.11. Recording transfer”, page 50).
- Server Directory** Server remote folder where recordings uploaded are saved (refer to section “7.11. Recording transfer”, page 50). If the set folder is not available on the FTP server, it is created automatically. On the contrary, on the SFTP server it must be created BEFORE carrying out this setup.

SCHEDULE

In this page the scheduled upload settings can be modified.

Real Time	Harmonics	Graphics	Recordings	Status	Setup	Administration
-----------	-----------	----------	------------	--------	-------	----------------

COMMUNICATION & DATA TRANSFER SETUP

Network FTP **Schedule** WiFi

Parameter	Setup	Description
Monday	19:00	Monday automatic host connection time
Tuesday	19:00	Tuesday automatic host connection time
Wednesday	19:00	Wednesday automatic host connection time
Thursday	19:00	Thursday automatic host connection time
Friday	19:00	Friday automatic host connection time
Saturday	19:00	Saturday automatic host connection time
Sunday	19:00	Sunday automatic host connection time
Delete data after upload	OFF	Enables data erase after FTP/SFTP server upload



- Monday** Monday time for automatic connection to the remote server for data upload (time format hh:mm). To disable the automatic connection, set “-” instead of the hour.
- Tuesday** Tuesday time for automatic connection to the remote server for data upload (time format hh:mm). To disable the automatic connection, set “-” instead of the hour.
- Wednesday** Wednesday time for automatic connection to the remote server for data upload (time format hh:mm). To disable the automatic connection, set “-” instead of the hour.
- Thursday** Thursday time for automatic connection to the remote server for data upload (time format hh:mm). To disable the automatic connection, set “-” instead of the hour.
- Friday** Friday time for automatic connection to the remote server for data upload (time format hh:mm). To disable the automatic connection, set “-” instead of the hour.
- Saturday** Saturday time for automatic connection to the remote server for data upload (time format hh:mm). To disable the automatic connection, set “-” instead of the hour.
- Sunday** Sunday time for automatic connection to the remote server for data upload (time format hh:mm). To disable the automatic connection, set “-” instead of the hour.
- Delete data after upload** Enabling this function (ON), the relevant recordings (except for Functional LOG) will be erased at the end of each upload to the remote server.

WiFi



In this page the WiFi network can be enabled in **Access Point** or **Client** mode. If **OFF**, WiFi function is disabled.

 Note: do not enable WiFi if it is not used.

 Note: before enabling and setting WiFi, connect the WiFi antenna to the instrument.

Real Time	Harmonics	Graphics	Recordings	Status	Setup	Administration
COMMUNICATION & DATA TRANSFER SETUP						 
Network	FTP	Schedule	WiFi			
Parameter	Setup	Description				
WiFi Mode	OFF 	WiFi Port functional mode in AP or Client				

To set the instrument WiFi network as access point, set **Access Point** in **WiFi Mode** field, the parameters for the instrument access point setup will be displayed.

Real Time	Harmonics	Graphics	Recordings	Status	Setup	Administration
COMMUNICATION & DATA TRANSFER SETUP						 
Network	FTP	Schedule	WiFi			
Parameter	Setup	Description				
WiFi Mode	Access Point 	WiFi Port functional mode in AP or Client				
SSID	DIRISQ800	Set SSID in AP mode to connect external devices				
Password	SOCOMECE1	Password in AP mode to be used on external devices				
Channel	6	WiFi channel number in AP mode				
IP Address	192.168.1.10	IP address of WiFi LAN port				

SSID ID of the WiFi network broadcasted by the instrument.

Password Access password for the WiFi network broadcasted by the instrument. Password rules: at least 8 but no more than 63 printable ASCII characters.

Channel Frequency channel of the WiFi network broadcasted by the instrument. Range: 1...13

IP Address Static IP address for WiFi port. To connect the instrument through WiFi, type this address in the web browser.

 Note:

- the WiFi network broadcasted by the instrument is in compliance with IEEE 802.11 standard as well as WPA protocol.
- WiFi port IP address must be set in a different IP class than LAN port, considering also LAN port Netmask setup.
- the WiFi subnet mask is not programmable but it is fixed to 255.255.255.0

To set the instrument WiFi network as client, first set **Client** in **WiFi Mode** field and then select the IP Mode:

- with **Manual** mode, enter manually static IP address, netmask and gateway IP address for WiFi port and then confirm the setup. The instrument will start to search for the available WiFi networks (about 1 min). Then, enable again the programming to select the available network (SSID) and set the corresponding password. Finally confirm the setup.
- with **DHCP** mode, confirm the setup. The instrument will start to search for the available WiFi networks (about 1 min). Then, enable again the programming to select the available network (SSID) and set the corresponding password. Finally confirm the setup.

COMMUNICATION & DATA TRANSFER SETUP



Network FTP Schedule **WiFi**

Parameter	Setup	Description
WiFi Mode	Client <input type="text"/>	WiFi Port functional mode in AP or Client
SSID	<input type="text"/>	SSID of the external AP where to connect as client
Password	SOCOMECE1 <input type="text"/>	Password to be used as Client to connect external APs
IP Address	192.168.1.10 <input type="text"/>	IP address of WiFi LAN port
Netmask	255.255.255.0 <input type="text"/>	WiFi instrument subnet mask
WiFi Gateway IP Address	192.168.1.255 <input type="text"/>	IP address of WiFi gateway providing web access

IP Mode IP mode for searching for available networks. Available choices: Manual or DHCP.

SSID List of the detected WIFI networks.

Password Access password for the selected WIFI network. Password rules: at least 8 but no more than 63 printable ASCII characters.

IP Address Static IP address for WIFI port. Make sure that WIFI IP address is set with a different IP class than LAN IP address.

Netmask WIFI subnet mask.

WiFi Gateway IP Address Gateway IP address over WIFI port.



Note:

- the IP address for both WIFI and LAN ports MUST HAVE A DIFFERENT IP class.
- the IP address for both WIFI port and WIFI gateway MUST HAVE the same IP class.

EMAIL

In this page it is possible to enable the sending of email in case of events/alarms.

Real Time	Harmonics	Graphics	Recordings	Status	Setup	Administration
-----------	-----------	----------	------------	--------	-------	----------------

COMMUNICATION & DATA TRANSFER SETUP

Network FTP Schedule WiFi **Email**

SMTP ACCESS PARAMETERS

Parameter	Setup	Description
Source mail address	<input type="text" value="username@domain.cc"/>	Sender email address
SMTP host	<input type="text" value="0.0.0.0"/>	SMTP server IP address or hostname
SMTP port	<input type="text" value="465"/>	SMTP port number (default 465)
Encryption method	<input type="text" value="STARTTLS"/>	Connection security
Authentication method	<input type="text" value="Encrypted passwor"/>	Authentication method
User	<input type="text" value="user"/>	SMTP access username
Password	<input type="password"/>	SMTP access password
Test email	<input type="button" value="Send"/>	Send test email to Destination addresses

EMAIL SETUP

Destinations	FuncEv.	SetupChg.	FastVolt.	SlowFreq.	DI	DO
<input type="text"/>	<input type="button" value="Dis"/>	<input type="button" value="Dis"/>	<input type="button" value="Dis"/>	<input type="button" value="Dis"/>	<input type="button" value="Dis"/>	<input type="button" value="Dis"/>
<input type="text"/>	<input type="button" value="Dis"/>	<input type="button" value="Dis"/>	<input type="button" value="Dis"/>	<input type="button" value="Dis"/>	<input type="button" value="Dis"/>	<input type="button" value="Dis"/>
<input type="text"/>	<input type="button" value="Dis"/>	<input type="button" value="Dis"/>	<input type="button" value="Dis"/>	<input type="button" value="Dis"/>	<input type="button" value="Dis"/>	<input type="button" value="Dis"/>
<input type="text"/>	<input type="button" value="Dis"/>	<input type="button" value="Dis"/>	<input type="button" value="Dis"/>	<input type="button" value="Dis"/>	<input type="button" value="Dis"/>	<input type="button" value="Dis"/>
<input type="text"/>	<input type="button" value="Dis"/>	<input type="button" value="Dis"/>	<input type="button" value="Dis"/>	<input type="button" value="Dis"/>	<input type="button" value="Dis"/>	<input type="button" value="Dis"/>

SMTP ACCESS PARAMETERS

Sender address	Email address of the sender (device). Make sure that the email account set for the device is valid.
SMTP server	SMTP server address relevant to the sender email account.
SMTP port	SMTP port relevant to the sender email account.
Security	Connection security. Available choices: None, STARTTLS, SSL/TLS.
Auth. method	Authentication method. Available choices: None, Normal password, Encrypted password.
Username	Username of the sender email account.
Password	Password of the sender email account.
Test	Send a test email to the first email address entered in the EMAIL SETUP/Destinations column. Press Send button and then confirm the whole setup of this page. This function has effect only after confirmation of the whole setup of this page.

EMAIL SETUP

Destinations	Up to 5 email addresses for the receipt of email in case of alarms/events.
FuncEv.	Enable/disable the email sending if a functional event occurs.
SetupChg.	Enable/disable the email sending if setup is changed.
FastVolt.	Enable/disable the email sending if a fast voltage event occurs.
SlowFreq.	Enable/disable the email sending if a slow frequency event occurs.
DI	Enable/disable the email sending if a digital input change occurs.
DO	Enable/disable the email sending if a digital output alarm occurs.

 **Note:**
- for proper functioning, check the permissions of email account access to non-standard applications.
- the automatic email is not compatible with Office365 operating system. Do not set an Office365 email account for the instrument.

8.7.7. Digital inputs

This section allows to enable the digital inputs.

Up to 4 digital inputs can be enabled to acquire the logical status of voltage protection signals.

Real Time	Harmonics	Graphics	Recordings	Status	Setup	Administration
DIGITAL INPUTS SETUP						
DI Channel	Status		Description			
Digital input 1	<input type="button" value="Dis"/>	<input type="button" value="En"/>	Mode selection (disab, enab)			
Digital input 2	<input type="button" value="Dis"/>	<input type="button" value="En"/>	Mode selection (disab, enab)			
Digital input 3	<input type="button" value="Dis"/>	<input type="button" value="En"/>	Mode selection (disab, enab)			
Digital input 4	<input type="button" value="Dis"/>	<input type="button" value="En"/>	Mode selection (disab, enab)			

8.7.8. Analog outputs

This section allows to display and change the settings for the instrument analog outputs.

Up to 4 analog outputs can be enabled to generate 4-20 mA signals proportional to the selected measurements. For each analog output channel, it is possible to perform the following settings:

Real Time	Harmonics	Graphics	Recordings	Status	Setup	Administration
ANALOG OUTPUTS SETUP						
AO Channel	Setup		Description			
Analog output 1	<input type="text" value="U1N"/>	<input type="text" value="200.00"/>	Parameter assigned to AO channel 1			
		<input type="text" value="250.00"/>	Minimum and Maximum fullscale values			
Analog output 2	<input type="text" value="None"/>		Parameter assigned to AO channel 2			
			Minimum and Maximum fullscale values			
Analog output 3	<input type="text" value="None"/>		Parameter assigned to AO channel 3			
			Minimum and Maximum fullscale values			
Analog output 4	<input type="text" value="None"/>		Parameter assigned to AO channel 4			
			Minimum and Maximum fullscale values			

Field 1 Measurement parameter to be assigned to the analog output channel (for parameter meaning, refer to the table in section “7.3. Measurement monitoring”, page 24).

In case of harmonic parameter, select the harmonic or interharmonic group in Field 2.

Field 2 Available only when Field 1=harmonic parameter. Harmonic&interharmonic group selection.

Field 3 Parameter minimum value to be assigned to the lower full scale (4 mA).

Field 4 Parameter maximum value to be assigned to the upper full scale (20 mA).

8.7.9. Digital outputs

This section allows to display and change the settings for the instrument digital outputs.

Up to 4 digital outputs can be set for alarm or pulse emission. Chose the digital output number in the sub-menu and select the **Signalling mode** in the list.

Real Time	Harmonics	Graphics	Recordings	Status	Setup	Administration
DIGITAL OUTPUTS SETUP 						
Dig. Out 1 Dig. Out 2 Dig. Out 3 Dig. Out 4						
DO Channel		Setup			Description	
Digital output 1		None <input type="button" value="v"/>			Signalling mode	

To set the digital output in alarm mode, select **Alarm H** for high alarm threshold or **Alarm L** for low alarm threshold. The following settings will be displayed and available to be modified.

Real Time	Harmonics	Graphics	Recordings	Status	Setup	Administration	
DIGITAL OUTPUTS SETUP 							
Dig. Out 1 Dig. Out 2 Dig. Out 3 Dig. Out 4							
DO Channel		Setup			Description		
Digital output 1		Alarm H <input type="button" value="v"/>			Signalling mode		
		① U1N <input type="button" value="v"/>	②		Parameter assigned to DO channel		
		③ 230.00	④ 5.0		Threshold absolute value and Hysteresis [%]		
		⑤ 4.000					Inactivity Delay (sensivity threshold) [s]

Field 1 Measurement parameter to be assigned to the digital output channel (for parameter meaning, refer to the table in section “7.3. Measurement monitoring”, page 24).

In case of harmonic parameter, select the harmonic or interharmonic group in Field 2.

Field 2 Available only when Field 1=harmonic parameter. Harmonic&interharmonic group selection.

Field 3 Threshold in absolute value, according to the signalling mode:

- Alarm H=maximum threshold referred to the full scale of the selected parameter
- Alarm L=minimum threshold referred to the full scale of the selected parameter

Field 4 Threshold hysteresis in percentage value. Range: 0.0...50.0%

Field 5 Threshold delay. The output will be activated only if the threshold over/under take condition is maintained for the set delay time. If not, the output will not be activated. Range: 0...10 s

To set the digital output in pulse mode, select **Pulse**. The following settings will be displayed and available to be modified.

Real Time Harmonics Graphics Recordings Status Setup Administration

DIGITAL OUTPUTS SETUP

Dig. Out 1 **Dig. Out 2** Dig. Out 3 Dig. Out 4

DO Channel	Setup	Description
Digital output 2	Pulse <input type="text" value="Pulse"/>	Signalling mode
	① Active EXP <input type="text" value="Active EXP"/>	Parameter assigned to DO channel 2
	② 5 <input type="text" value="5"/>	Pulse number / energy MU (e.g 1000pls/kWh)
	③ 50 <input type="text" value="50"/>	Pulse length [ms] in 50-250ms range

- Field 1** Energy counter to be assigned to the digital output channel (for energy counter meaning, refer to the table in section “7.3. Measurement monitoring”, page 24).
- Field 2** Pulse value in p/kWh, p/kvarh or p/kVAh according to the selected energy counter (p=pulse).
- Field 3** Pulse length. Range: 50...250 ms, with 10 ms step

To set the digital output in functional alarm mode, select **Functional alarm**. The triggering event relevant to functional alarm will be displayed and available to be modified.

Real Time Harmonics Graphics Recordings Status Setup Administration

DIGITAL OUTPUTS SETUP

Dig. Out 1 **Dig. Out 2** Dig. Out 3 Dig. Out 4

DO Channel	Setup	Description
Digital output 1	Functional alarm <input type="text" value="Functional alarm"/>	Signalling mode
	① Missing AUX supp <input type="text" value="Missing AUX supp"/>	Parameter assigned to DO channel

Field ① Triggering event to be assigned to the digital output channel. Available choices:

- Missing AUX supply=in case of missing auxiliary power supply, the output will be activated after 3 s about (function available only if backup battery switch is ON).
- Low battery=in case of low battery, the output will be activated immediately.
- No GPS lock=in case of RTC not locked on GPS signal, the output will be activated immediately.

To manage the enabling/disabling of digital output by Modbus protocol, select **Modbus**.

Real Time Harmonics Graphics Recordings Status Setup Administration

DIGITAL OUTPUTS SETUP

Dig. Out 1 **Dig. Out 2** Dig. Out 3 Dig. Out 4

DO Channel	Setup	Description
Digital output 1	Modbus <input type="text" value="Modbus"/>	Signalling mode

 Note: digital output 1 assigned to Active Metrological LED has automatically a constant period proportional to the active energy during the generation of pulses.

8.8. Administration

This section is reserved to Administrator. It allows to carry out some important instrument settings like change administrator password, update the instrument firmware, save/load instrument configuration file, etc.

Real Time	Harmonics	Graphics	Recordings	Status	Setup	Administration
ADMINISTRATION						
Operation		Description				
File		Select the new PFU firmware file to be downloaded into the device				
Upgrade		Press the Upgrade button to download the new firmware in the device				
		File upload progress				
Restart		Press the Restart button to perform a reboot of the device				
Defaults		Performs a set default operation (Warning, default IP address will be restored!)				
Load		Select the new Setup file to be downloaded into the device				
Save		Save into a local file the device setup parameters				
Reset DMDMAX		Reset all DMD MAX (Peak) values with their timestamp				
Reset Counters		Reset the Energy counters				
Clear Records		Remove all recording files, exception Functional LOG. WARNING! This operation cannot be reverted				
Password		Change the administrator password				
English		User interface language selection				
DISPLAY BOARD OPTIONS						
Operation		Description				
File		Select the new Display firmware file to be downloaded into the device				
Upgrade		Press the Upgrade button to download the new firmware in the display interface				
		Uploading progress				

ADMINISTRATION

- File button** It allows to select the firmware file (.PFU) for the instrument upgrading.
- Upgrade button** Upgrade the instrument with the uploaded file. This button is active only if a proper PFU file was uploaded.
- Progress bar** Show the file uploading progress in case of instrument firmware upgrade.
- Restart button** Perform an instrument reboot. Wait 60...90 s for the complete instrument reboot.
- Defaults button** Restore the instrument factory setup except for LAN IP address, Netmask, Gateway DNS, NTP address and recorded data. A warning message will be displayed : press **Yes**, the current instrument setup will be erased and will not be retrieveable.
- Load button** It allows to upload a specific XML file containing the previously saved instrument configuration (refer to section “8.8.2. Instrument configuration XML file uploading”, page 107).
- Save button** It allows to save the current instrument configuration in an XML file. The file name will be structured with the instrument name, the serial number and the file saving date (e.g. P-001_Setup_B110N59001_141105.xml).
- Reset DMDMAX** Reset the demand MAX values. A warning message will be displayed: press **Yes**, all demand MAX values will be erased and will not be retrieveable.
- Reset button** Reset the energy counters. A warning message will be displayed: press **Yes**, all energy counters will be erased and will not be retrieveable.
- Password button** Change administrator password (refer to section “8.8.3. Administrator password”, page 108).
- Language box** Select the language for both instrument and Web server. Available choices: English, Italian, German, French, Spanish, Polish, Chinese, Turkish.

DISPLAY BOARD OPTIONS

File button	It allows to select the firmware file (.PXU) for the display interface upgrading.
Upgrade button	Upgrade the display interface with the uploaded file. This button is active only if a proper PXU file was uploaded.
Progress bar	Show the the file uploading progress in case of display interface upgrade.

8.8.1. Instrument firmware upgrade



WARNING! PLEASE READ CAREFULLY!

The firmware upgrade operation must be carried out by paying attention to the following:

- wait till each operation is finished
- do not change the web browser page
- do not perform update if the device is in battery power
- do not power OFF the device or do not switch OFF the battery
- do not perform update via WIFI but only via Ethernet connection
- do not remove the Ethernet cable
- do not shut down the PC
- do not switch pages over the front TFT Display

During update on the display some specific indications may be displayed.



WARNING! After upgrading, it is suggested to delete the browser cache and check all instrument settings.



Note: after upgrading, the instrument is automatically set to the default language (English). Access with the latest Administrator password to change the language.

To upgrade the instrument firmware version, refer to the following procedure:

1. Access Web server and then press **Administration** menu button, a password will be requested.
2. Insert the administrator password and confirm with **Yes**.
3. Upload the provided PFU file by clicking on **File** button in “Administration” area.
4. Press **Upgrade** button.
5. Wait a message which will confirm that the file was uploaded successfully.
6. Finally reboot the instrument by clicking on **Restart** button and wait until the instrument will be ready to use (60...90 s).

8.8.2. Instrument configuration XML file uploading



WARNING! Do not upload any XML file if the instrument is powered by backup battery.



WARNING! It is not possible to upload XML files not generated by the instrument.

To upload the configuration file on the instrument, refer to the following procedure:

1. Access Web server and then press **Administration** menu button, a password will be requested.
2. Insert the administrator password and confirm with **Yes**.
3. Upload the proper XML file (e.g. P-001_Setup_B110N59001_141105.xml) by clicking on **Load**.
4. After file selection and confirmation, a warning message will be displayed.
5. Confirm with **Yes** button, the configuration file will be uploaded and the instrument will be operating with the new setup profile.

8.8.3. Administrator password



WARNING! If the administrator password is lost, restore the instrument with the set default procedure, using the RES button on the front panel (refer to section “4.1. Front panel”, page 7).

To change the administrator password, press **Password** button, the following window will be displayed.

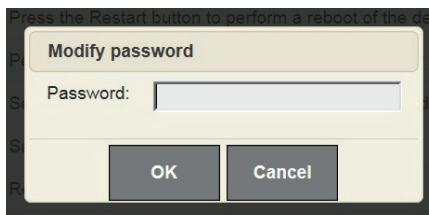

The new password to be set must have the following requirements:

- at least 6 characters but no more than 20 characters
- at least one letter (e.g. a b c)
- at least one number (e.g. 1 2 3)

Insert the new password and confirm with **OK**.

The password is modified successfully only if the message “Operation performed” is shown.

8.8.4. Display interface upgrade



WARNING! PLEASE READ CAREFULLY!

The firmware upgrade operation must be carried out by paying attention to the following:

- wait till each operation is finished
- do not change the web browser page
- do not perform update if the device is in battery power
- do not power OFF the device or do not switch OFF the battery
- do not perform update via WIFI but only via Ethernet connection
- do not remove the Ethernet cable
- do not shut down the PC
- do not switch pages over the front TFT Display

During update on the display some specific indications may be displayed.



WARNING! Before upgrading the display interface, carry out instrument firmware upgrade procedure.



Note: this function cannot be performed by instrument display, by using USB port

To upgrade the display interface firmware, refer to the following procedure:

1. Access Web server and then press **Administration** menu button, a password will be requested.
2. Insert the administrator password and confirm with **Yes**.
3. Upload the provided PXU file by clicking on **File** button in “Display board options” area.
4. Press **Upgrade** button, a confirmation message will be displayed. Confirm it to start the upgrade.
5. Wait a message which confirm that upgrade is performed successfully, in that moment the instrument performs a final reboot automatically and it will be ready to use after 60...90 s.

9. DIRIS Q800 CLASS A MONITORING TOOL

The measured/calculated parameters requested for IEC/EN 61000-4-30:2015 Ed.3 Class A certification are provided from the instrument through a communication channel. To display all these parameters a software tool is provided.

9.1. How to start DIRIS Q800 Monitoring Tool

PC minimum configuration:

- Microsoft Windows® XP, 7, 8, 10 operating system
- LAN port

Install the software by double clicking on **PQM-Tool_Setup.exe** file and follow the instructions on the screen. Run the software tool by double-clicking on the corresponding desktop icon. In the following window connect the instrument with the set IP address. For further details on the tool operation, press the **HELP** button.

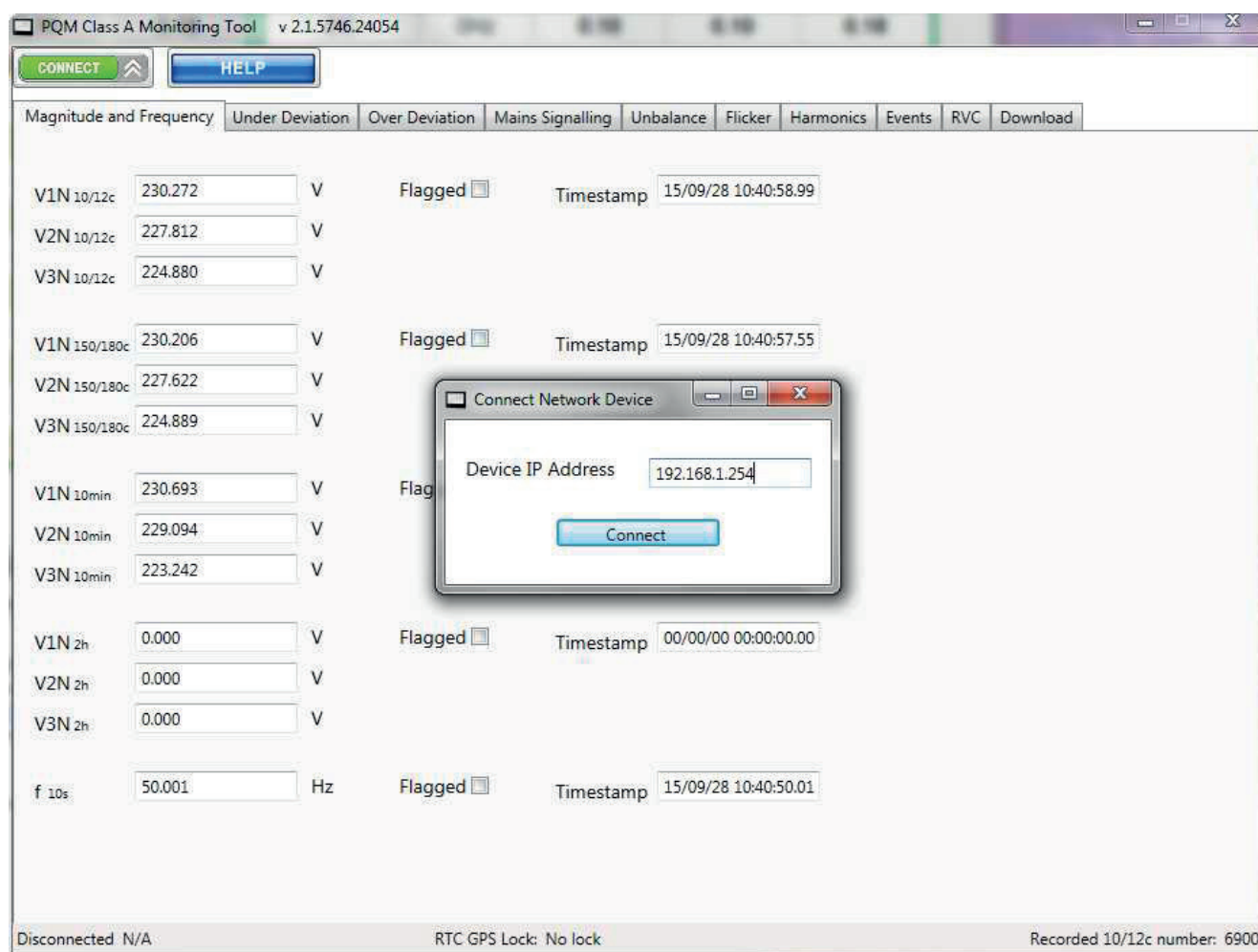

10. MAINTENANCE

The instrument is maintenance-free in case of problem contact the manufacturer. Clean the front panel, if required, using a clean soft cloth. Do not use fluids, solvents or detergents which may damage the instrument.

Prior to any work on or in the device, isolate the voltage inputs and auxiliary power supplies and short-circuit the secondary winding of all current transformers (PTI SOCOMEC).

10.1. INSTRUMENT END-OF-LIFE

According to the 2012/19/EU directive relevant to the reduction of dangerous substances in electric and electronic appliances, as well as waste disposal, the symbol of a crossed dustbin applied on appliances or on their cases means that the product at the end of its life cycle must be disposed in a dedicated location than other waste.

The user must, therefore, dispose the appliance at its end-of-life in the relevant disposal site for electric and electronic waste or give it back to resellers at the time of purchasing a new equivalent one.

The correct disposal and consequent start up of a recycling of the unused appliance, treatment and final disposal compatible to the environment concurs to avoid possible negative effects on the environment and health and favours the reusing and / or recycling of the parts making the apparatus. The abusive disposal of such products done by users is fined according to the present.

11. TECHNICAL SPECIFICATIONS

The instrument technical specifications are following described.

POWER SUPPLY	
Auxiliary power voltage	100...240 VAC 50/60 Hz / 65...250 VDC
Refer to the value indicated on the instrument	19...60 VDC on request
Auxiliary power consumption	15 VA max
Fuse (according to the power supply)	250 VAC / 500 mA T type delayed (35 A breaking capacity) with
Refer to the value indicated on the instrument	100...240 VAC 50/60 Hz 15 W / 65...250 VDC power supply 250 VAC / 3 A T type delayed with 19...60 VDC power supply
Backup battery	Li-Ion, 2500 mAh (>15 min autonomy)
MEASUREMENTS INPUTS	
Voltage inputs for direct connection	Phase-neutral: max 580 V RMS CAT III Phase-phase: max 1000 V RMS CAT III
U4 voltage input for direct connection	max 580 V RMS CAT III
Voltage input crest factor	2
CT inputs	max 7 A RMS
CT burden	0.04 VA
Current clamp inputs	2 selectable scales: 1, 3 V RMS
Current input crest factor	3
Wiring modes	Three phases, 4 wires, 4 currents (3.4.4) - 4NBL Three phases, 4 wires, 3 currents (3.4.3) - 4NBL Three phases, 3 wires, 3 currents (3.3.3) - 3NBL Three phases, 3 wires, 2 currents (3.3.2) - 3NBL Two phases, 3 wires, 3 currents (2.3.3) - 2NBL Single phase, 2 wires, 1 current (1.2.1) - 1BL
Input impedance (for direct voltage inputs)	>6 MΩ
Frequency range	42.5...57.5 Hz / 51...69 Hz
Frequency reference channel	Phase 1/Line 12 voltage
Sampling	Simultaneous, 51.2 kHz @50 Hz
ACCURACY	
Three phase voltage	±0.1% Un over 10...150% Un range
4th voltage	±0.2% measurement
Currents	±0.2% measurement (device)
Powers	±0.2% measurement
Frequency	±10 mHz
Harmonics	Class 1 (IEC/EN 61000-4-7)
Internal clock (RTC)	<1 s for 24h period without synchronisation <5 ms with GPS synchronisation <500 ms with NTP synchronisation
Active energy	Class 0,2 S, compliant to IEC/EN 62053-22
Reactive energy	Class 1, compliant to IEC/EN 62053-24
CALCULATION TECHNIQUES	
Voltage	Compliant to IEC/EN 61000-4-30:2015 Ed.3, Class A
4th voltage	Continuous sampling, 10/12 cycles
Currents	Compliant to IEC/EN 61000-4-30:2015 Ed.3, Class A
I4 (Neutral), I5 (Earth Leakage) currents	Continuous sampling, 10/12 cycles
Voltage unbalance	Compliant to IEC/EN 61000-4-30:2015 Ed.3, Class A
Current unbalance	Compliant to IEC/EN 61000-4-30:2015 Ed.3, Class A
Voltage and current harmonics, THD	Up to 63rd order, compliant with IEC/EN 61000-4-7, Class 1
Voltage and current interharmonics	5 Hz bin @ 50/60 Hz, compliant with IEC/EN 61000-4-7
Underdeviations and overdeviations	Compliant to IEC/EN 61000-4-30:2015 Ed.3, Class A
Flicker	Compliant to IEC/EN 61000-4-15

Frequency	Compliant to IEC/EN 61000-4-30:2015 Ed.3, Class A
Rapid voltage changes	Compliant to IEC/EN 61000-4-30:2015 Ed.3, Class A
Powers	Active and reactive, four quadrants
True and displacement power factor	Four quadrants
Mains signalling	5 user frequency
Aggregations	Compliant to IEC/EN 61000-4-30:2015 Ed.3, Class A
Voltage event hysteresis	Programmable 1...25% Un
I/O CHANNELS	
Digital inputs	4 optoisolated 24 VDC
Analog outputs	4 optoisolated 4...20 mA DC, max load 500 Ω
Digital outputs	4 passive optoisolated 24 VDC/ max 50 mA
Digital input delay time (1...4)	max 10 ms
Digital input consumption (1...4)	max 7 mA DC
Analog output reaction time	max 200 ms
Digital output reaction time (DO in Alarm mode)	max 1 s
Digital output pulse length (DO in Pulse mode)	50 ±2 ms ON time
MEMORY	
System memory	128 MB Flash, 256 MB RAM
Recording memory	16 GB
COMMUNICATION	
ETHERNET ports	2 Auto MDIX RJ45 10/100 Base Ethernet
RS485 port	1 optoisolated, 4800...115200 bps
GPS port	1 SMA female connector
WIFI port	1 SMA male connector
Protocols	HTTP, HTTPS, FTP, SFTP, NTP, NMEA, Modbus RTU/TCP, WPA, SMTP
RTC SYNCHRONISATION	
Synchronisation system	NTP and/or GPS
ENVIRONMENTAL CONDITIONS	
Installation and use code	PQI-A-FI1
Operating temperature (limit range)	-25...+55°C (FI1, 3K6)
Storage temperature	-25...+75°C (2K3)
Relative humidity	95% max without condensing
Altitude	max 2000 m AMSL
Installation & use	Internal
MECHANICAL CHARACTERISTICS	
Mounting	Panel mount 192x144 DIN size
Size	Front (L x H): 191x143 mm Rear (L x H x D): 183 x 135 x 190 mm
Weight	1400 g
DIRECTIVE AND STANDARD COMPLIANCE	
Directive	2014/30/EU, 2014/35/EU, 2014/53/EU
Product compliance	IEC/EN 62586-1, IEC/EN 62586-2
Safety	EN 61010
Pollution degree	2 (EN 61010-1)
Protection degree	IP40 front panel, IP20 rear
Protection against mechanical impacts	IK06
Directive	RED §3.1a Health EN 62311 :2008 RED § 3.1b EMC

12. SPECIFICATIONS FOR IEC/EN 61000-4-30:2015 ED.3 COMPLIANCE

The instrument specifications for IEC/EN 61000-4-30:2015 Ed.3 compliance are following described.

FREQUENCY (5.1)	
Uncertainty	±10 mHz
Measuring range	42.5 Hz – 57.5 Hz, 51 Hz – 69 Hz
MAGNITUDE OF SUPPLY VOLTAGE (5.2)	
Uncertainty	±0.1% of U _{din}
Measuring range	10% – 150% of U _{din}
FLICKER (5.3)	
Uncertainty	±5% of reading
Measuring range	0.2 – 10 Pst
SUPPLY VOLTAGE DIPS AND SWELLS (5.4)	
Uncertainty	Magnitude: ±0.2% of U _{din} Duration: ±1 cycle
VOLTAGE INTERRUPTIONS (5.5)	
Uncertainty	Duration: ±1 cycle
UNBALANCE (5.7)	
Uncertainty	±0.15%
Measuring range	0.5% – 5% ι_2 0.5% – 5% ι_0
HARMONICS (5.8)	
Uncertainty	IEC/EN 61000-4-7 Class I
Measuring range	10% – 200% Class 3 of IEC/EN 61000-2-4
INTERHARMONICS (5.9)	
Uncertainty	IEC/EN 61000-4-7 Class I
Measuring range	10% – 200% Class 3 of IEC/EN 61000-2-4
MAINS SIGNALLING (5.10)	
Uncertainty	±5% of reading with measuring range 3%-15% of U _{din} ±0.15% of reading with measuring range 1%-3% of U _{din}
Measuring range	0% – 15% of U _{din}
RAPID VOLTAGE CHANGES (5.11)	
Uncertainty	Magnitude: ±0.2% of U _{din}
UNDERDEVIATION AND OVERDEVIATION (5.12)	
Uncertainty	Consistent with “Magnitude of supply voltage (5.2)”
Measuring range	10% – 150% of U _{din}
CURRENT (5.13)	
Uncertainty	±1%
Measuring range	10% - 150% of FS (FS = 1 A or 5 A programmable)

The instrument meets IEC/EN 61000-4-30:2015 Ed.3 Class A requirements for:

- Aggregations
- Time Clock Uncertainty
- Flagging
- Transient Influence Quantities

12.1. DIRIS Q800 - Analyser software for EN 50160 analysis

DIRIS Q800 - Analyzer software allows to perform the instrument recorded data analysis according to EN 50160 standard.

An analysis can be performed both on data downloaded directly by the instrument and on data already stored on PC. In the first case, enter the instrument IP address and the relevant port to access to the instrument by FTP protocol. Download data by pressing **Download** button and wait until the end downloading.

In the second case, select the data folder by pressing **Import** button and then import data previously downloaded by the instrument. For a complete and correct analysis, all the following file types are needed, saved in a single folder:

Setup, mAMLog, FuncLog, evSlowVolt, evSlowFreq, evRVC, evMS, evFastVolt.

Then select the analysis period, **Full recording period** to analyse the total period or **Custom recording period** to analyse a specific period only (programmable).

Finally perform the analysis by pressing **Analyze** button..

Q800 EN 50160 Data Analyzer v1.4.6543.22693

English

Device

Data folder

C:\DOC\EN50160_Analyze_1

Browse...

Download

Device IP Address

Cancel

Download

Device selection

B380R50003

Save Report

Operator

Site name

Analyze

After data folder selection, press **Analyze** button.

A sum up table will be displayed with a result overview, more details are shown on the other tabs.

The screenshot shows the 'Q800 EN 50160 Data Analyzer v1.4.6543.22693' window. The 'Sum-up table' tab is selected, displaying the 'EN 50160/A1:2015 ANALYSIS SUMMARY'. The table lists various power quality parameters and their results. The recording period is from 22/09/2017 19:20:00 to 02/10/2017 09:00:00.

Device	EN 50160/A1:2015 ANALYSIS SUMMARY	
Sum-up table	Recording period	22/09/2017 19:20:00 ÷ 02/10/2017 09:00:00
Power frequency	Power frequency	Fail
Supply voltage variations	Supply voltage variations	Fail
Rapid voltage changes	Rapid voltage changes	Pass
Flicker severity	Flicker severity	Pass
Supply voltage unbalance	Supply voltage unbalance	Fail
Harmonic voltage	Harmonic voltage	Fail
Mains signalling voltages	Mains signalling voltages	Pass
Voltage Interruptions	Short interruptions of the supply voltage	Analyzed
Supply voltage dips	Medium interruptions of the supply voltage	Analyzed
Supply voltage swells	Long interruptions of the supply voltage	Analyzed
Setup		



Note: the time for data downloading can change according to the data file. With bigger file size, more time is needed.

13. TROUBLE-SHOOTING

Event	Event Information or Result	Cause	Action
No recording is saved	Web server Recordings area do not list any file	Wrong setup, measured values out of range	For events check thresholds setup and check if the device is not continuously in event. For mAM check if general Enable in ON and specific parameters are enabled
No new recording	Only old recorded data is available	Memory full	Download some of the mAM files separately and free some memory space before download TAR files
Recording memory lost	Web server Recordings area do not list any file	Internal memory damaged	Save/Download systematically the recorded data by setting up the Scheduled FTP push, or download over web server, or transfer to USB stick
Ethernet communication lost	No access to the device web server; No data link in Modbus TCP or Modbus over TCP; No data upload to FTP Server	Ethernet cable may be damaged or not correctly connected	Change ethernet cable
Ethernet communication lost	No access to the device web server; No data link in Modbus TCP or Modbus over TCP; No data upload to FTP Server	Ethernet cable RJ45 connector may be oxidated, so the electrical contact is poor	Change ethernet cable or change RJ45 connector
Ethernet communication lost	No access to the device web server; No data link in Modbus TCP or Modbus over TCP; No data upload to FTP Server	IP parameters (IP address, gateway, netmask, port number) may be changed	Check locally on display these parameters, set again correct parameters
Ethernet communication lost	No access to the device web server; No data link in Modbus TCP or Modbus over TCP; No data upload to FTP Server	Internet access may be not available	Check router setup for correct NAT
No internet connection	Impossible to access internet services, such as remote access, NTP server, FTP server	Wrong setup in the device	Check correct gateway IP address and netmask according to the router setup
No internet connection	Impossible to access internet services, such as remote access, NTP server, FTP server	Wrong setup in the router	Check correct NAT (Network Address Translation) or forward setup in the router
RS485 communication lost	No data link in Modbus RTU	RS485 may be damaged or terminal not connected	Change cable, check RS485 terminal connections, check correct A & B signals polarity
RS485 communication lost	No data link in Modbus RTU	RS485 parameters (baudrate, address) may be changed	Check locally on display or by web server these parameters, set again correct parameters
RS485 communication lost	No data link in Modbus RTU	Master software communication parameters changed	Check software communication parameters setup for correct COM port number, correct baudrate and correct slave address
RS485 communication lost	No data link in Modbus RTU	Poor cable quality, to long cable, to many slaves on the RS485 network	Change cable, reduce cable length, reduce baudrate, limit slave number on RS485 segment to 32
GPS Signal Lost	GPSSYNC LED is OFF; Web server Status page "GPS Status" is not OK	During winter months, snow may cover the GPS antenna.	Remove the snow, and check periodically if there is no snow on the GPS antenna
GPS Signal Lost	GPSSYNC LED is OFF; Web server Status page "GPS Status" is not OK	During summer months, trees may cover a good signal reception	Change antenna position, to have ideally 360 sky view
GPS Signal Lost	GPSSYNC LED is OFF; Web server Status page "GPS Status" is not OK	Cable may be damaged	Change the antenna
Low battery capacity	When the device remains powered in battery, the duration is low	Battery is not charged	Check battery switch on the back side, must be in ON status; check battery status on the web server Status page
Low battery capacity	When the device remains powered in battery, the duration is low	Device may operate at high temperature, battery capacity is reduced	Change the battery with a new one

ANNEXE I. MODBUS - COMMUNICATION PROTOCOL

1. DESCRIPTION

MODBUS RTU is a master-slave communication protocol, able to support up to 247 slaves connected in a bus or a star network.

The protocol uses a simplex connection on a single line. In this way, the communication messages move on a single line in two opposite directions.

MODBUS TCP is a variant of the MODBUS family. Specifically, it covers the use of MODBUS messaging in an "Intranet" or "Internet" environment using the TCP/IP protocol on a fixed port **502**.

Master-slave messages can be:

- **Reading (Function code \$03 / \$04):** the communication is between the master and a single slave. It allows to read information about the queried instrument.
- **Writing (Function code \$10):** the communication is between the master and a single slave. It allows to change the instrument settings.

In a multi-point type connection (MODBUS RTU), **slave address** (called also **MODBUS address**) allows to identify each instrument during the communication. Each instrument is preset with a default slave address (01) and the user can change it.

In case of MODBUS TCP, slave address is replaced by a single byte, the **Unit ID**.

COMMUNICATION FRAME STRUCTURE

RTU mode:

Bit per byte: 1 Start, 8 Bit, None, 1 Stop (8N1)

Name	Length	Function
START FRAME	4 chars idle	At least 4 character time of silence (MARK condition)
ADDRESS FIELD	8 bits	Instrument MODBUS address
FUNCTION CODE	8 bits	Function code (\$03 / \$04 / \$10)
DATA FIELD	n x 8 bits	Data + length will be filled depending on the message type
ERROR CHECK	16 bits	Error check (CRC)
END FRAME	4 chars idle	At least 4 character time of silence between frames

TCP mode

Bit per byte: 1 Start, 7 Bit, Even, 2 Stop (7E2)

Name	Length	Function
TRANSACTION ID	2 bytes	For synchronization between messages of server & client
PROTOCOL ID	2 bytes	Zero for MODBUS TCP
BYTE COUNT	2 bytes	Number of remaining bytes in this frame
UNIT ID	1 byte	Slave address (\$FF if not used)
FUNCTION CODE	1 byte	Function code (\$01 / \$04 / \$10)
DATA BYTES	n bytes	Data as response or command

1.1. CRC generation

The Cyclical Redundancy Check (CRC) field is two bytes, containing a 16-bit value. The CRC value is calculated by the transmitting device, which appends the CRC to the message. The receiving device recalculates a CRC during receipt of the message, and compares the calculated value to the actual value it received in the CRC field. If the two values are not equal, an error results.

The CRC is started by first preloading a 16-bit register to all 1's. Then a process begins of applying successive 8-bit bytes of the message to the current contents of the register. Only the eight bits of data in each character are used for generating the CRC. Start and stop bits, and the parity bit, do not apply to the CRC.

During generation of the CRC, each 8-bit character is exclusive ORed with the register contents. Then the result is shifted in the direction of the least significant bit (LSB), with a zero filled into the most significant bit (MSB) position. The LSB is extracted and examined. If the LSB was a 1, the register is then exclusive ORed with a preset, fixed value. If the LSB was a 0, no exclusive OR takes place.

This process is repeated until eight shifts have been performed. After the last (eighth) shift, the next 8-bit character is exclusive ORed with the register's current value, and the process repeats for eight more shifts as described above. The final contents of the register, after all the characters of the message have been applied, is the CRC value.

A calculated procedure for generating a CRC is:

1. Load a 16-bit register with \$FFFF. Call this the CRC register.
2. Exclusive OR the first 8-bit byte of the message with the low-order byte of the 16-bit CRC register, putting the result in the CRC register.
3. Shift the CRC register one bit to the right (toward the LSB), zero-filling the MSB. Extract and examine the LSB.
4. (If the LSB was 0): Repeat Step 3 (another shift).
(If the LSB was 1): Exclusive OR the CRC register with the polynomial value \$A001 (1010 0000 0000 0001).
5. Repeat Steps 3 and 4 until 8 shifts have been performed. When this is done, a complete 8-bit byte will have been processed.
6. Repeat Steps 2 through 5 for the next 8-bit byte of the message. Continue doing this until all bytes have been processed.
7. The final contents of the CRC register is the CRC value.
8. When the CRC is placed into the message, its upper and lower bytes must be swapped as described below.

PLACING THE CRC INTO THE MESSAGE

When the 16-bit CRC (two 8-bit bytes) is transmitted in the message, the low-order byte will be transmitted first, followed by the high-order byte.

For example, if the CRC value is \$35F7 (0011 0101 1111 0111):

Addr	Func	Data Count	Data	Data	...	Data	CRC lo F7	CRC hi 35
------	------	---------------	------	------	-----	------	--------------	--------------

CRC GENERATION FUNCTIONS - With Table

All of the possible CRC values are preloaded into two arrays, which are simply indexed as the function increments through the message buffer. One array contains all of the 256 possible CRC values for the high byte of the 16-bit CRC field, and the other array contains all of the values for the low byte. Indexing the CRC in this way provides faster execution than would be achieved by calculating a new CRC value with each new character from the message buffer.

```
/*CRC table for calculate with polynom 0xA001 with init value 0xFFFF, High half word*/
rom unsigned char CRC_Table_Hi[] = {
    0x00, 0xC1, 0x81, 0x40, 0x01, 0xC0, 0x80, 0x41, 0x01, 0xC0, 0x80, 0x41, 0x00, 0xC1, 0x81,
    0x40, 0x01, 0xC0, 0x80, 0x41, 0x00, 0xC1, 0x81, 0x40, 0x00, 0xC1, 0x81, 0x40, 0x01, 0xC0,
    0x80, 0x41, 0x01, 0xC0, 0x80, 0x41, 0x00, 0xC1, 0x81, 0x40, 0x00, 0xC1, 0x81, 0x40, 0x01,
    0xC0, 0x80, 0x41, 0x00, 0xC1, 0x81, 0x40, 0x01, 0xC0, 0x80, 0x41, 0x01, 0xC0, 0x80, 0x41,
    0x00, 0xC1, 0x81, 0x40, 0x01, 0xC0, 0x80, 0x41, 0x00, 0xC1, 0x81, 0x40, 0x00, 0xC1, 0x81,
    0x40, 0x01, 0xC0, 0x80, 0x41, 0x00, 0xC1, 0x81, 0x40, 0x01, 0xC0, 0x80, 0x41, 0x01, 0xC0,
    0x80, 0x41, 0x00, 0xC1, 0x81, 0x40, 0x00, 0xC1, 0x81, 0x40, 0x01, 0xC0, 0x80, 0x41, 0x01,
    0xC0, 0x80, 0x41, 0x00, 0xC1, 0x81, 0x40, 0x01, 0xC0, 0x80, 0x41, 0x00, 0xC1, 0x81, 0x40,
    0x00, 0xC1, 0x81, 0x40, 0x01, 0xC0, 0x80, 0x41, 0x01, 0xC0, 0x80, 0x41, 0x00, 0xC1, 0x81,
    0x40, 0x00, 0xC1, 0x81, 0x40, 0x01, 0xC0, 0x80, 0x41, 0x00, 0xC1, 0x81, 0x40, 0x01, 0xC0,
    0x80, 0x41, 0x01, 0xC0, 0x80, 0x41, 0x00, 0xC1, 0x81, 0x40, 0x00, 0xC1, 0x81, 0x40, 0x01,
    0xC0, 0x80, 0x41, 0x01, 0xC0, 0x80, 0x41, 0x00, 0xC1, 0x81, 0x40, 0x00, 0xC1, 0x81,
    0x40, 0x01, 0xC0, 0x80, 0x41, 0x01, 0xC0, 0x80, 0x41, 0x00, 0xC1, 0x81, 0x40, 0x01,
    0xC0, 0x80, 0x41, 0x00, 0xC1, 0x81, 0x40, 0x00, 0xC1, 0x81, 0x40, 0x01, 0xC0, 0x80, 0x41,
    0x00, 0xC1, 0x81, 0x40, 0x01, 0xC0, 0x80, 0x41, 0x01, 0xC0, 0x80, 0x41, 0x00, 0xC1, 0x81,
    0x40
};

/*CRC table for calculate with polynom 0xA001 with init value 0xFFFF, Low half word*/
rom unsigned char CRC_Table_Lo[] = {
    0x00, 0xC0, 0xC1, 0x01, 0xC3, 0x03, 0x02, 0xC2, 0xC6, 0x06, 0x07, 0xC7, 0x05, 0xC5, 0xC4,
    0x04, 0xCC, 0x0C, 0x0D, 0xCD, 0x0F, 0xCF, 0xCE, 0x0E, 0x0A, 0xCA, 0xCB, 0x0B, 0xC9, 0x09,
    0x08, 0xC8, 0xD8, 0x18, 0x19, 0xD9, 0x1B, 0xDB, 0xDA, 0x1A, 0x1E, 0xDE, 0xDF, 0x1F, 0xDD,
    0x1D, 0x1C, 0xDC, 0x14, 0xD4, 0xD5, 0x15, 0xD7, 0x17, 0x16, 0xD6, 0xD2, 0x12, 0x13, 0xD3,
    0x11, 0xD1, 0xD0, 0x10, 0xF0, 0x30, 0x31, 0xF1, 0x33, 0xF3, 0xF2, 0x32, 0x36, 0xF6, 0xF7,
    0x37, 0xF5, 0x35, 0x34, 0xF4, 0x3C, 0xFC, 0xFD, 0x3D, 0xFF, 0x3F, 0x3E, 0xFE, 0xFA, 0x3A,
    0x3B, 0xFB, 0x39, 0xF9, 0xF8, 0x38, 0x28, 0xE8, 0xE9, 0x29, 0xEB, 0x2B, 0x2A, 0xEA, 0xEE,
    0x2E, 0x2F, 0xEF, 0x2D, 0xED, 0xEC, 0x2C, 0xE4, 0x24, 0x25, 0xE5, 0x27, 0xE7, 0xE6, 0x26,
    0x22, 0xE2, 0xE3, 0x23, 0xE1, 0x21, 0x20, 0xE0, 0xA0, 0x60, 0x61, 0xA1, 0x63, 0xA3, 0xA2,
    0x62, 0x66, 0xA6, 0xA7, 0x67, 0xA5, 0x65, 0x64, 0xA4, 0x6C, 0xAC, 0xAD, 0x6D, 0xAF, 0x6F,
    0x6E, 0xAE, 0xAA, 0x6A, 0x6B, 0xAB, 0x69, 0xA9, 0xAB, 0x68, 0x78, 0xB8, 0xB9, 0x79, 0xBB,
    0x7B, 0x7A, 0xBA, 0xBE, 0x7E, 0xBF, 0x7D, 0xBD, 0xBC, 0x7C, 0xB4, 0x74, 0x75, 0xB5,
    0x77, 0xB7, 0xB6, 0x76, 0x72, 0xB2, 0xB3, 0x73, 0xB1, 0x71, 0x70, 0xB0, 0x50, 0x90, 0x91,
    0x51, 0x93, 0x53, 0x52, 0x92, 0x96, 0x56, 0x57, 0x97, 0x55, 0x95, 0x94, 0x54, 0x9C, 0x5C,
    0x5D, 0x9D, 0x5F, 0x9F, 0x9E, 0x5E, 0x5A, 0x9A, 0x9B, 0x5B, 0x99, 0x59, 0x58, 0x98, 0x88,
    0x48, 0x49, 0x89, 0x4B, 0x8B, 0x8A, 0x4A, 0x4E, 0x8E, 0x8F, 0x4F, 0x8D, 0x4D, 0x4C, 0x8C,
    0x44, 0x84, 0x85, 0x45, 0x87, 0x47, 0x46, 0x86, 0x82, 0x42, 0x43, 0x83, 0x41, 0x81, 0x80,
    0x40
};

};

unsigned short ModBus_CRC16( unsigned char * Buffer, unsigned short Length )
{
    unsigned char CRCHi = 0xFF;
    unsigned char CRCLo = 0xFF;
    int Index;
    unsigned short ret;

    while( Length-- )
    {
        Index = CRCLo ^ *Buffer++;
        CRCLo = CRCHi ^ CRC_Table_Hi[Index];
        CRCHi = CRC_Table_Lo[Index];
    }
    ret=((unsigned short)CRCHi << 8);
    ret|= (unsigned short)CRCLo;
    return ret;
}
```

CRC GENERATION FUNCTIONS - Without Table

```
unsigned short ModBus_CRC16( unsigned char * Buffer, unsigned short Length )
{
/* ModBus_CRC16 Calculatd CRC16 with polynome 0xA001 and init value 0xFFFF
Input *Buffer - pointer on data
Input Length - number byte in buffer
Output - calculated CRC16
*/
    unsigned int cur_crc;

    cur_crc=0xFFFF;
    do
    {
        unsigned int i = 8;
        cur_crc = cur_crc ^ *Buffer++;
        do
        {
            if (0x0001 & cur_crc)
            {
                cur_crc >>= 1;
                cur_crc ^= 0xA001;
            }
            else
            {
                cur_crc >>= 1;
            }
        }
        while (--i);
    }
    while (--Length);

    return cur_crc;
}
```

2. COMMAND STRUCTURE

The master communication device can send reading commands to the slave (instrument). The structure for reading commands is following described according to the used communication protocol (RTU or TCP).

2.1. MODBUS RTU

In this section, the tables describe the reading command structure (Query). The command is followed by a response sent by slave.

These tables refer to a master-slave communication in MODBUS RTU.

READING COMMAND STRUCTURE (function code \$03/\$04)

The master communication device can send commands to the instrument to read its status, setup and the measured values. More registers can be read, at the same time, sending a single command, only if the registers are consecutive. Values contained both in Query and Response messages are in hex format.

Structure	Example	Byte
Slave address	01	-
Function code	03	-
Starting register	00	High
	00	Low
Words to be read	00	High
	02	Low
CRC	0B	High
	C4	Low

Query example: 0103000000020BC4

Structure	Example	Byte
Slave address	01	-
Function code	03	-
Data bytes	04	-
Requested reading data	00	High
	03	Low
	92	High
	10	Low
CRC	9F	High
	66	Low

Response example: 010304000392109F66

2.2. MODBUS TCP

In this section, the tables describe the reading command structure (Query) and the writing command structure. Both commands are followed by a response sent by slave.

These tables refer to a master-slave communication in MODBUS TCP.

READING COMMAND STRUCTURE

The master communication device can send commands to the instrument to read its status, setup and the measured values. More registers can be read, at the same time, sending a single command, only if the registers are consecutive (see chapter "4. Register tables", page 126). Values contained both in Query and Response messages are in hex format.

Structure	Example	Byte
Transaction ID	01	-
	00	High
Protocol ID	00	Low
	00	High
	00	Low
Data bytes	06	-
Unit ID	01	-
Function code	03	-
Starting register	00	High
	00	Low
Words to be read	00	High
	02	Low

Query example: 010000000006010300000002

Structure	Example	Byte
Transaction ID	01	-
	00	High
Protocol ID	00	Low
	00	High
	00	Low
Data bytes	07	-
Unit ID	01	-
Function code	03	-
Reading bytes	04	-
	00	High
Requested reading data	03	Low
	92	High
	10	Low

Response example: 01000000000701030400039210

2.3. Floating point as per IEEE Standard

The basic format allows a IEEE standard floating-point number to be represented in a single 32 bit format, as shown below:

$$N.n = (-1)^S 2^{e'-127} (1.f)$$

where **S** is the sign bit, **e'** is the first part of the exponent and **f** is the decimal fraction placed next to 1. Internally the exponent is 8 bits in length and the stored fraction is 23 bits long.

A round to nearest method is applied to the calculated value of floating point.

The floating-point format is shown as follows:

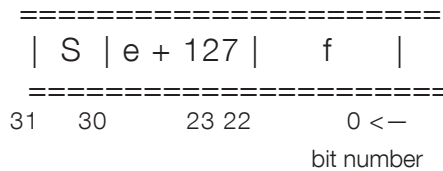

where:

	bit length
Sign	1
Exponent	8
Fraction	23 + (1)
Total	m = 32 + (1)
Exponent	
Min e'	0
Max e'	255
Bias	127

Note: fractions (decimals) are always shown while the leading 1 (hidden bit) is not stored.

EXAMPLE OF CONVERSION OF VALUE SHOWN WITH FLOATING POINT

Value read with floating point:

45AACC00₍₁₆₎

Value converted in binary format:

010001011 010101011001100000000000₍₂₎

	exponent	fraction

sign

sign = 0

exponent = 10001011₍₂₎ = 139₍₁₀₎

fraction = 010101011001100000000000₍₂₎ / 8388608₍₁₀₎ =
= 2804736₍₁₀₎ / 8388608₍₁₀₎ = 0.334350585₍₁₀₎

$$\begin{aligned}
 N.n &= (-1)^S 2^{e'-127} (1+f) = \\
 &= (-1)^0 2^{139-127} (1.334350585) = \\
 &= (+1) (4096) (1.334350585) = \\
 &= 5465.5
 \end{aligned}$$

3. EXCEPTION CODES

When the slave (instrument) receives a not-valid query or command, an error response is sent. The error response structure is following described according to the used communication protocol (RTU or TCP).

3.1. MODBUS RTU

In this section, the table describes the error response structure following to a not-valid query or command. This table refers to a master-slave communication in MODBUS RTU.

Values contained in Response messages are in hex format.

Structure	Example	Byte
Slave address	01	-
Function code + \$80 (e.g. 03+80, 04+80, 10+80, according to the query/ command)	83	-
Exception code	01	-
CRC	F0	High
	80	Low

Response example: 018301F080

Exception codes for MODBUS RTU are following described:

- \$01 ILLEGAL FUNCTION:** the function code received in the query is not an allowable action.
- \$02 ILLEGAL DATA ADDRESS:** the data address received in the query is not an allowable address (e.g. the combination of register and transfer length is invalid).
- \$03 ILLEGAL DATA VALUE:** a value contained in the query data field is not an allowable value.
- \$04 ILLEGAL RESPONSE LENGTH:** the request would generate a response with size bigger than that available for MODBUS protocol.

3.2. MODBUS TCP

In this section, the table describes the error response structure following to a not-valid query or command. This table refers to a master-slave communication in MODBUS TCP.

Values contained in Response messages are in hex format.

Structure	Example	Byte
Transaction ID	01	-
Protocol ID	00	High
	00	Low
	00	High
	00	Low
Data bytes	03	-
Unit ID	01	-
Function code + \$80 (e.g. 03+80, 04+80, 10+80, according to the query/command)	83	-
Exception code	01	-

Response example: 010000000003018301

Exception codes for MODBUS TCP are following described:

- \$01 ILLEGAL FUNCTION:** the function code is unknown by the server.
- \$02 ILLEGAL DATA ADDRESS:** the data address received in the query is not an allowable address for the slave (i.e. the combination of register and transfer length is invalid).
- \$03 ILLEGAL DATA VALUE:** a value contained in the query data field is not an allowable value for the slave.
- \$04 SERVER FAILURE:** the server failed during the execution.
- \$05 ACKNOWLEDGE:** the server accepted the server invocation but the service requires a relatively long time to execute. The server therefore returns only an acknowledgement of the service invocation receipt.
- \$06 SERVER BUSY:** the server was unable to accept the MB request PDU. The client application has the responsibility of deciding if and when re-sending the request.
- \$0A GATEWAY PATH UNAVAILABLE:** the slave is not configured or cannot communicate.
- \$0B GATEWAY TARGET DEVICE FAILED TO RESPOND:** the slave is not available in the network.

4. REGISTER TABLES

Note: highest number of registers (or bytes) which can be read with a single command:

- in RTU mode: 127 registers
- in TCP mode: 256 bytes

Note: highest number of registers which can be programmed with a single command:

- in RTU mode: 29 registers
- in TCP mode: 1 register



Note: the register values are in hex format (\$).

TABLE HEADER	MEANING
Parameter	Measuring parameter to be read
Register description	Description of the register to be read / written
F. code (Hex)	Function code in hex format. It identifies the command type (reading / writing)
Sign	If this column is checked, the read register value can have positive or negative sign. The negative values are represented with 2's complement. In case of TPF and DPF parameters, it means that the read register can be inductive or capacitive. Positive sign= inductive, Negative sign=capacitive
INTEGER	Details for INTEGER type registers
IEEE	Details for IEEE standard type registers
Register (Hex)	Register address in hex format
Words	Number of word to be read / written for the register (length)
M.U.	Measuring unit of parameter
Data meaning	Description of data received by a response of a reading command
Programmable data	Description of data which can be sent for a writing command

4.1. Registers (Function code \$03 / \$04 / \$06 / \$10)

Parameter	F. code (Hex)	Sign	M.U.	INTEGER		IEEE	
				Register (Hex)	Words	Register (Hex)	Words
REAL TIME VALUES							
Phase 1 to Neutral Voltage (U1N)	03 / 04	-	mV	0000	2	B000	2
Phase 2 to Neutral Voltage (U2N)	03 / 04	-	mV	0002	2	B002	2
Phase 3 to Neutral Voltage (U3N)	03 / 04	-	mV	0004	2	B004	2
4th Voltage (U4)	03 / 04	-	mV	0006	2	B006	2
Line 1 to 2 Voltage (U12)	03 / 04	-	mV	0008	2	B008	2
Line 2 to 3 Voltage (U23)	03 / 04	-	mV	000A	2	B00A	2
Line 3 to 1 Voltage (U31)	03 / 04	-	mV	000C	2	B00C	2
System Voltage (U Σ)	03 / 04	-	mV	000E	2	B00E	2
Line 4 to Phase 1 Voltage (U41)	03 / 04	-	mV	0010	2	B010	2
Line 4 to Phase 2 Voltage (U42)	03 / 04	-	mV	0012	2	B012	2
Line 4 to Phase 3 Voltage (U43)	03 / 04	-	mV	0014	2	B014	2
Negative Sequence Unbalance Ratio (μ 2)	03 / 04	-	m%	0016	2	B016	2
Zero Sequence Unbalance Ratio (μ 0)	03 / 04	-	m%	0018	2	B018	2
Positive Sequence Voltage (U1)	03 / 04	-	mV	001A	2	B01A	2
Negative Sequence Voltage (U2)	03 / 04	-	mV	001C	2	B01C	2
Zero Sequence Voltage (U0)	03 / 04	-	mV	001E	2	B01E	2

Parameter	F. code (Hex)	Sign	M.U.	INTEGER		IEEE	
				Register (Hex)	Words	Register (Hex)	Words
Phase 1 Current (I1)	03 / 04	X	mA	0020	2	B020	2
Phase 2 Current (I2)	03 / 04	X	mA	0022	2	B022	2
Phase 3 Current (I3)	03 / 04	X	mA	0024	2	B024	2
System Current (I Σ)	03 / 04	X	mA	0026	2	B026	2
Phase 4 Current (I4)	03 / 04	X	mA	0028	2	B028	2
Earth Leakage current (I5)	03 / 04	X	mA	002A	2	B02A	2
Current Negative Sequence Unbalance Ratio (i2)	03 / 04	-	m%	002C	2	B02C	2
Current Zero Sequence Unbalance Ratio (i0)	03 / 04	-	m%	002E	2	B02E	2
Positive Sequence Current (I1)	03 / 04	-	mA	0030	2	B030	2
Negative Sequence Current (I2)	03 / 04	-	mA	0032	2	B032	2
Zero Sequence Current (I0)	03 / 04	-	mA	0034	2	B034	2
Phase 1 Active Power (P1)	03 / 04	X	mW	0036	4	B036	2
Phase 2 Active Power (P2)	03 / 04	X	mW	003A	4	B038	2
Phase 3 Active Power (P3)	03 / 04	X	mW	003E	4	B03A	2
System Active Power (P Σ)	03 / 04	X	mW	0042	4	B03C	2
Phase 1 Reactive Power (Q1)	03 / 04	X	mvar	0046	4	B03E	2
Phase 2 Reactive Power (Q2)	03 / 04	X	mvar	004A	4	B040	2
Phase 3 Reactive Power (Q3)	03 / 04	X	mvar	004E	4	B042	2
System Reactive Power (Q Σ)	03 / 04	X	mvar	0052	4	B044	2
Phase 1 Apparent Power (S1)	03 / 04	-	mVA	0056	4	B046	2
Phase 2 Apparent Power (S2)	03 / 04	-	mVA	005A	4	B048	2
Phase 3 Apparent Power (S3)	03 / 04	-	mVA	005E	4	B04A	2
System Apparent Power (S Σ)	03 / 04	-	mVA	0062	4	B04C	2
Phase 1 True Power Factor (TPF1)	03 / 04	X	0.001	0066	2	B04E	2
Phase 2 True Power Factor (TPF2)	03 / 04	X	0.001	0068	2	B050	2
Phase 3 True Power Factor (TPF3)	03 / 04	X	0.001	006A	2	B052	2
System True Power Factor (TPF Σ)	03 / 04	X	0.001	006C	2	B054	2
Phase 1 Displacement Power Factor (DPF1)	03 / 04	X	0.001	006E	2	B056	2
Phase 2 Displacement Power Factor (DPF2)	03 / 04	X	0.001	0070	2	B058	2
Phase 3 Displacement Power Factor (DPF3)	03 / 04	X	0.001	0072	2	B05A	2
Phase 1 to Neutral Voltage Total Harmonic Distortion (THDU1N)	03 / 04	-	0.01%	0074	2	B05C	2
Phase 2 to Neutral Voltage Total Harmonic Distortion (THDU2N)	03 / 04	-	0.01%	0076	2	B05E	2
Phase 3 to Neutral Voltage Total Harmonic Distortion (THDU3N)	03 / 04	-	0.01%	0078	2	B060	2
Reserved	03 / 04	-	-	007A	2	B062	2
Line 1 to 2 Voltage Total Harmonic Distortion (THDU12)	03 / 04	-	0.01%	007C	2	B064	2
Line 2 to 3 Voltage Total Harmonic Distortion (THDU23)	03 / 04	-	0.01%	007E	2	B066	2
Line 3 to 1 Voltage Total Harmonic Distortion (THDU31)	03 / 04	-	0.01%	0080	2	B068	2
Phase 1 Current Total Harmonic Distortion (THDI1)	03 / 04	-	0.01%	0082	2	B06A	2
Phase 2 Current Total Harmonic Distortion (THDI2)	03 / 04	-	0.01%	0084	2	B06C	2
Phase 3 Current Total Harmonic Distortion (THDI3)	03 / 04	-	0.01%	0086	2	B06E	2
Phase 4 Current Total Harmonic Distortion (THDI4)	03 / 04	-	0.01%	0088	2	B070	2
Reserved	03 / 04	-	-	008A	2	B072	2
Phase Sequence	03 / 04	-	-	008C	2	B074	2
System Frequency (f)	03 / 04	-	mHz	008E	2	B076	2
Phase 1N (L12) Short Term Flicker (Pst1)	03 / 04	-	0.001	0090	2	B078	2
Phase 2N (L23) Short Term Flicker (Pst2)	03 / 04	-	0.001	0092	2	B07A	2
Phase 3N (L31) Short Term Flicker (Pst3)	03 / 04	-	0.001	0094	2	B07C	2
Phase 1N (L12) Long Term Flicker (Plt1)	03 / 04	-	0.001	0096	2	B07E	2
Phase 2N (L23) Long Term Flicker (Plt2)	03 / 04	-	0.001	0098	2	B080	2
Phase 3N (L31) Long Term Flicker (Plt3)	03 / 04	-	0.001	009A	2	B082	2
Reserved	03 / 04	-	0.01°	009C	2	B084	2

Parameter	F. code (Hex)	Sign	M.U.	INTEGER		IEEE	
				Register (Hex)	Words	Register (Hex)	Words
U2 Angle Relative to U1 - On fundamental (AngU1U2)	03 / 04	-	0.01°	009E	2	B086	2
U3 Angle Relative to U1 - On fundamental (AngU1U3)	03 / 04	-	0.01°	00A0	2	B088	2
U4 Angle Relative to U1 - On fundamental (AngU1U4)	03 / 04	-	0.01°	00A2	2	B08A	2
I1 Angle Relative to U1 - On fundamental (AngU1I1)	03 / 04	-	0.01°	00A4	2	B08C	2
I2 Angle Relative to U1 - On fundamental (AngU1I2)	03 / 04	-	0.01°	00A6	2	B08E	2
I3 Angle Relative to U1 - On fundamental (AngU1I3)	03 / 04	-	0.01°	00A8	2	B090	2
I4 Angle Relative to U1 - On fundamental (AngU1I4)	03 / 04	-	0.01°	00AA	2	B092	2
I5 Angle Relative to U1 - On fundamental (AngU1I5)	03 / 04	-	0.01°	00AC	2	B094	2
Phase 1 K Factor (K1)	03 / 04	X	-	00AE	2	B096	2
Phase 2 K Factor (K2)	03 / 04	X	-	00B0	2	B098	2
Phase 3 K Factor (K3)	03 / 04	X	-	00B2	2	B09A	2

ENERGY COUNTERS

Imported Active Energy	03 / 04	-	0.1Wh	1B00	4	C500	2
Exported Active Energy	03 / 04	-	0.1Wh	1B04	4	C502	2
Imported Apparent Energy - IND/LAGGING	03 / 04	-	0.1VAh	1B08	4	C504	2
Imported Apparent Energy - CAP/LEADING	03 / 04	-	0.1VAh	1B0C	4	C506	2
Exported Apparent Energy - IND/LAGGING	03 / 04	-	0.1VAh	1B10	4	C508	2
Exported Apparent Energy - CAP/LEADING	03 / 04	-	0.1VAh	1B14	4	C50A	2
Imported Reactive Energy - IND/LAGGING	03 / 04	-	0.1varh	1B18	4	C50C	2
Imported Reactive Energy - CAP/LEADING	03 / 04	-	0.1varh	1B1C	4	C50E	2
Exported Reactive Energy - IND/LAGGING	03 / 04	-	0.1varh	1B20	4	C510	2
Exported Reactive Energy - CAP/LEADING	03 / 04	-	0.1varh	1B24	4	C512	2

DEMAND VALUES

Phase 1 Current Demand (I1DMD)	03 / 04	-	mA	3000	2	D000	2
Phase 2 Current Demand (I2DMD)	03 / 04	-	mA	3002	2	D002	2
Phase 3 Current Demand (I3DMD)	03 / 04	-	mA	3004	2	D004	2
Line 4 Current Demand (I4DMD)	03 / 04	-	mA	3006	2	D006	2
Line 5 (Earth Leakage) Current Demand (I5DMD)	03 / 04	-	mA	3008	2	D008	2
System Current Demand (I Σ DMD)	03 / 04	-	mA	300A	2	D00A	2
Phase 1 Negative Active Power Demand (-P1DMD)	03 / 04	-	mW	300C	4	D00C	2
Phase 1 Positive Active Power Demand (+P1DMD)	03 / 04	-	mW	3010	4	D00E	2
Phase 2 Negative Active Power Demand (-P2DMD)	03 / 04	-	mW	3014	4	D010	2
Phase 2 Positive Active Power Demand (+P2DMD)	03 / 04	-	mW	3018	4	D012	2
Phase 3 Negative Active Power Demand (-P3DMD)	03 / 04	-	mW	301C	4	D014	2
Phase 3 Positive Active Power Demand (+P3DMD)	03 / 04	-	mW	3020	4	D016	2
System Negative Active Power Demand (-P Σ DMD)	03 / 04	-	mW	3024	4	D018	2
System Positive Active Power Demand (+P Σ DMD)	03 / 04	-	mW	3028	4	D01A	2
Phase 1 Negative Reactive Power Demand (-Q1DMD)	03 / 04	-	mvar	302C	4	D01C	2
Phase 1 Positive Reactive Power Demand (+Q1DMD)	03 / 04	-	mvar	3030	4	D01E	2
Phase 2 Negative Reactive Power Demand (-Q2DMD)	03 / 04	-	mvar	3034	4	D020	2
Phase 2 Positive Reactive Power Demand (+Q2DMD)	03 / 04	-	mvar	3038	4	D022	2
Phase 3 Negative Reactive Power Demand (-Q3DMD)	03 / 04	-	mvar	303C	4	D024	2
Phase 3 Positive Reactive Power Demand (+Q3DMD)	03 / 04	-	mvar	3040	4	D026	2
System Negative Reactive Power Demand (-Q Σ DMD)	03 / 04	-	mvar	3044	4	D028	2
System Positive Reactive Power Demand (+Q Σ DMD)	03 / 04	-	mvar	3048	4	D02A	2
Phase 1 Negative Apparent Power Demand (-S1DMD)	03 / 04	-	mVA	304C	4	D02C	2
Phase 1 Positive Apparent Power Demand (+S1DMD)	03 / 04	-	mVA	3050	4	D02E	2
Phase 2 Negative Apparent Power Demand (-S2DMD)	03 / 04	-	mVA	3054	4	D030	2
Phase 2 Positive Apparent Power Demand (+S2DMD)	03 / 04	-	mVA	3058	4	D032	2
Phase 3 Negative Apparent Power Demand (-S3DMD)	03 / 04	-	mVA	305C	4	D034	2
Phase 3 Positive Apparent Power Demand (+S3DMD)	03 / 04	-	mVA	3060	4	D036	2

Parameter	F. code (Hex)	Sign	M.U.	INTEGER		IEEE	
				Register (Hex)	Words	Register (Hex)	Words
System Negative Apparent Power Demand (-S Σ DMD)	03 / 04	-	mVA	3064	4	D038	2
System Positive Apparent Power Demand (+S Σ DMD)	03 / 04	-	mVA	3068	4	D03A	2
Phase 1 Negative True Power Factor Demand (-S1DMD)	03 / 04	-	0.001	306C	2	D03C	2
Phase 1 Positive True Power Factor Demand (+S1DMD)	03 / 04	-	0.001	306E	2	D03E	2
Phase 2 Negative True Power Factor Demand (-S2DMD)	03 / 04	-	0.001	3070	2	D040	2
Phase 2 Positive True Power Factor Demand (+S2DMD)	03 / 04	-	0.001	3072	2	D042	2
Phase 3 Negative True Power Factor Demand (-S3DMD)	03 / 04	-	0.001	3074	2	D044	2
Phase 3 Positive True Power Factor Demand (+S3DMD)	03 / 04	-	0.001	3076	2	D046	2
System Negative True Power Factor Demand (-S Σ DMD)	03 / 04	-	0.001	3078	2	D048	2
System Positive True Power Factor Demand (+S Σ DMD)	03 / 04	-	0.001	307A	2	D04A	2

DEMAND MAX VALUES

Phase 1 Current DMD MAX (I1DMDMAX) - Previous Month	03 / 04	-	mA	3F00	2	DF00	2
Timestamp in Compact BCD format	03 / 04	-	10ms	3F02	4	DF02	4
Phase 1 Current DMD MAX (I1DMDMAX) - Actual Month	03 / 04	-	mA	3F06	2	DF06	2
Timestamp in Compact BCD format	03 / 04	-	10ms	3F08	4	DF08	4
Phase 1 Current DMD MAX (I1DMDMAX) - Previous Week	03 / 04	-	mA	3F0C	2	DF0C	2
Timestamp in Compact BCD format	03 / 04	-	10ms	3F0E	4	DF0E	4
Phase 1 Current DMD MAX (I1DMDMAX) - Actual Week	03 / 04	-	mA	3F12	2	DF12	2
Timestamp in Compact BCD format	03 / 04	-	10ms	3F14	4	DF14	4
Phase 1 Current DMD MAX (I1DMDMAX) - Previous Day	03 / 04	-	mA	3F18	2	DF18	2
Timestamp in Compact BCD format	03 / 04	-	10ms	3F1A	4	DF1A	4
Phase 1 Current DMD MAX (I1DMDMAX) - Actual Day	03 / 04	-	mA	3F1E	2	DF1E	2
Timestamp in Compact BCD format	03 / 04	-	10ms	3F20	4	DF20	4
Phase 2 Current DMD MAX (I2DMDMAX) - Previous Month	03 / 04	-	mA	3F24	2	DF24	2
Timestamp in Compact BCD format	03 / 04	-	10ms	3F26	4	DF26	4
Phase 2 Current DMD MAX (I2DMDMAX) - Actual Month	03 / 04	-	mA	3F2A	2	DF2A	2
Timestamp in Compact BCD format	03 / 04	-	10ms	3F2C	4	DF2C	4
Phase 2 Current DMD MAX (I2DMDMAX) - Previous Week	03 / 04	-	mA	3F30	2	DF30	2
Timestamp in Compact BCD format	03 / 04	-	10ms	3F32	4	DF32	4
Phase 2 Current DMD MAX (I2DMDMAX) - Actual Week	03 / 04	-	mA	3F36	2	DF36	2
Timestamp in Compact BCD format	03 / 04	-	10ms	3F38	4	DF38	4
Phase 2 Current DMD MAX (I2DMDMAX) - Previous Day	03 / 04	-	mA	3F3C	2	DF3C	2
Timestamp in Compact BCD format	03 / 04	-	10ms	3F3E	4	DF3E	4
Phase 2 Current DMD MAX (I2DMDMAX) - Actual Day	03 / 04	-	mA	3F42	2	DF42	2
Timestamp in Compact BCD format	03 / 04	-	10ms	3F44	4	DF44	4
Phase 3 Current DMD MAX (I3DMDMAX) - Previous Month	03 / 04	-	mA	3F48	2	DF48	2
Timestamp in Compact BCD format	03 / 04	-	10ms	3F4A	4	DF4A	4
Phase 3 Current DMD MAX (I3DMDMAX) - Actual Month	03 / 04	-	mA	3F4E	2	DF4E	2
Timestamp in Compact BCD format	03 / 04	-	10ms	3F50	4	DF50	4
Phase 3 Current DMD MAX (I3DMDMAX) - Previous Week	03 / 04	-	mA	3F54	2	DF54	2
Timestamp in Compact BCD format	03 / 04	-	10ms	3F56	4	DF56	4
Phase 3 Current DMD MAX (I3DMDMAX) - Actual Week	03 / 04	-	mA	3F5A	2	DF5A	2
Timestamp in Compact BCD format	03 / 04	-	10ms	3F5C	4	DF5C	4
Phase 3 Current DMD MAX (I3DMDMAX) - Previous Day	03 / 04	-	mA	3F60	2	DF60	2
Timestamp in Compact BCD format	03 / 04	-	10ms	3F62	4	DF62	4
Phase 3 Current DMD MAX (I3DMDMAX) - Actual Day	03 / 04	-	mA	3F66	2	DF66	2
Timestamp in Compact BCD format	03 / 04	-	10ms	3F68	4	DF68	4
Line 4 Current DMD MAX (I4DMDMAX) - Previous Month	03 / 04	-	mA	3F6C	2	DF6C	2
Timestamp in Compact BCD format	03 / 04	-	10ms	3F6E	4	DF6E	4
Line 4 Current DMD MAX (I4DMDMAX) - Actual Month	03 / 04	-	mA	3F72	2	DF72	2
Timestamp in Compact BCD format	03 / 04	-	10ms	3F74	4	DF74	4

Parameter	F. code (Hex)	Sign	M.U.	INTEGER		IEEE	
				Register (Hex)	Words	Register (Hex)	Words
Line 4 Current DMD MAX (I4DMDMAX) - Previous Week	03 / 04	-	mA	3F78	2	DF78	2
Timestamp in Compact BCD format	03 / 04	-	10ms	3F7A	4	DF7A	4
Line 4 Current DMD MAX (I4DMDMAX) - Actual Week	03 / 04	-	mA	3F7E	2	DF7E	2
Timestamp in Compact BCD format	03 / 04	-	10ms	3F80	4	DF80	4
Line 4 Current DMD MAX (I4DMDMAX) - Previous Day	03 / 04	-	mA	3F84	2	DF84	2
Timestamp in Compact BCD format	03 / 04	-	10ms	3F86	4	DF86	4
Line 4 Current DMD MAX (I4DMDMAX) - Actual Day	03 / 04	-	mA	3F8A	2	DF8A	2
Timestamp in Compact BCD format	03 / 04	-	10ms	3F8C	4	DF8C	4
Line 5 (EL) Current DMD MAX (I5DMDMAX) - Previous Month	03 / 04	-	mA	3F90	2	DF90	2
Timestamp in Compact BCD format	03 / 04	-	10ms	3F92	4	DF92	4
Line 5 (EL) Current DMD MAX (I5DMDMAX) - Actual Month	03 / 04	-	mA	3F96	2	DF96	2
Timestamp in Compact BCD format	03 / 04	-	10ms	3F98	4	DF98	4
Line 5 (EL) Current DMD MAX (I5DMDMAX) - Previous Week	03 / 04	-	mA	3F9C	2	DF9C	2
Timestamp in Compact BCD format	03 / 04	-	10ms	3F9E	4	DF9E	4
Line 5 (EL) Current DMD MAX (I5DMDMAX) - Actual Week	03 / 04	-	mA	3FA2	2	DFA2	2
Timestamp in Compact BCD format	03 / 04	-	10ms	3FA4	4	DFA4	4
Line 5 (EL) Current DMD MAX (I5DMDMAX) - Previous Day	03 / 04	-	mA	3FA8	2	DFA8	2
Timestamp in Compact BCD format	03 / 04	-	10ms	3FAA	4	DFAA	4
Line 5 (EL) Current DMD MAX (I5DMDMAX) - Actual Day	03 / 04	-	mA	3FAE	2	DFAE	2
Timestamp in Compact BCD format	03 / 04	-	10ms	3FB0	4	DFB0	4
System Current DMD MAX (IΣDMDMAX) - Previous Month	03 / 04	-	mA	3FB4	2	DFB4	2
Timestamp in Compact BCD format	03 / 04	-	10ms	3FB6	4	DFB6	4
System Current DMD MAX (IΣDMDMAX) - Actual Month	03 / 04	-	mA	3FBA	2	DFBA	2
Timestamp in Compact BCD format	03 / 04	-	10ms	3FBC	4	DFBC	4
System Current DMD MAX (IΣDMDMAX) - Previous Week	03 / 04	-	mA	3FC0	2	DFC0	2
Timestamp in Compact BCD format	03 / 04	-	10ms	3FC2	4	DFC2	4
System Current DMD MAX (IΣDMDMAX) - Actual Week	03 / 04	-	mA	3FC6	2	DFC6	2
Timestamp in Compact BCD format	03 / 04	-	10ms	3FC8	4	DFC8	4
System Current DMD MAX (IΣDMDMAX) - Previous Day	03 / 04	-	mA	3FCC	2	DFCC	2
Timestamp in Compact BCD format	03 / 04	-	10ms	3FCE	4	DFCE	4
System Current DMD MAX (IΣDMDMAX) - Actual Day	03 / 04	-	mA	3FD2	2	DFD2	2
Timestamp in Compact BCD format	03 / 04	-	10ms	3FD4	4	DFD4	4
Phase 1 Neg. Active Power DMD MAX (-P1DMDMAX) - Previous Month	03 / 04	-	mW	3FD8	4	DFD8	2
Timestamp in Compact BCD	03 / 04	-	10ms	3FDC	4	DFDA	4
Phase 1 Pos. Active Power DMD MAX (+P1DMDMAX) - Previous Month	03 / 04	-	mW	3FE0	4	DFDE	2
Timestamp in Compact BCD	03 / 04	-	10ms	3FE4	4	DFE0	4
Phase 1 Neg. Active Power DMD MAX (-P1DMDMAX) - Actual Month	03 / 04	-	mW	3FE8	4	DFE4	2
Timestamp in Compact BCD	03 / 04	-	10ms	3FEC	4	DFE6	4
Phase 1 Pos. Active Power DMD MAX (+P1DMDMAX) - Actual Month	03 / 04	-	mW	3FF0	4	DFEA	2
Timestamp in Compact BCD	03 / 04	-	10ms	3FF4	4	DFEC	4
Phase 1 Neg. Active Power DMD MAX (-P1DMDMAX) - Previous Week	03 / 04	-	mW	3FF8	4	DFF0	2
Timestamp in Compact BCD	03 / 04	-	10ms	3FFC	4	DFF2	4
Phase 1 Pos. Active Power DMD MAX (+P1DMDMAX) - Previous Week	03 / 04	-	mW	4000	4	DFF6	2
Timestamp in Compact BCD	03 / 04	-	10ms	4004	4	DFF8	4
Phase 1 Neg. Active Power DMD MAX (-P1DMDMAX) - Actual Week	03 / 04	-	mW	4008	4	DFFC	2
Timestamp in Compact BCD	03 / 04	-	10ms	400C	4	DFFE	4
Phase 1 Pos. Active Power DMD MAX (+P1DMDMAX) - Actual Week	03 / 04	-	mW	4010	4	E002	2
Timestamp in Compact BCD	03 / 04	-	10ms	4014	4	E004	4
Phase 1 Neg. Active Power DMD MAX (-P1DMDMAX) - Previous Day	03 / 04	-	mW	4018	4	E008	2
Timestamp in Compact BCD	03 / 04	-	10ms	401C	4	E00A	4
Phase 1 Pos. Active Power DMD MAX (+P1DMDMAX) - Previous Day	03 / 04	-	mW	4020	4	E00E	2

Parameter	F. code (Hex)	Sign	M.U.	INTEGER		IEEE	
				Register (Hex)	Words	Register (Hex)	Words
Timestamp in Compact BCD	03 / 04	-	10ms	4024	4	E010	4
Phase 1 Neg. Active Power DMD MAX (-P1DMDMAX) - Actual Day	03 / 04	-	mW	4028	4	E014	2
Timestamp in Compact BCD	03 / 04	-	10ms	402C	4	E016	4
Phase 1 Pos. Active Power DMD MAX (+P1DMDMAX) - Actual Day	03 / 04	-	mW	4030	4	E01A	2
Timestamp in Compact BCD	03 / 04	-	10ms	4034	4	E01C	4
Phase 2 Neg. Active Power DMD MAX (-P2DMDMAX) - Previous Month	03 / 04	-	mW	4038	4	E020	2
Timestamp in Compact BCD	03 / 04	-	10ms	403C	4	E022	4
Phase 2 Pos. Active Power DMD MAX (+P2DMDMAX) - Previous Month	03 / 04	-	mW	4040	4	E026	2
Timestamp in Compact BCD	03 / 04	-	10ms	4044	4	E028	4
Phase 2 Neg. Active Power DMD MAX (-P2DMDMAX) - Actual Month	03 / 04	-	mW	4048	4	E02C	2
Timestamp in Compact BCD	03 / 04	-	10ms	404C	4	E02E	4
Phase 2 Pos. Active Power DMD MAX (+P2DMDMAX) - Actual Month	03 / 04	-	mW	4050	4	E032	2
Timestamp in Compact BCD	03 / 04	-	10ms	4054	4	E034	4
Phase 2 Neg. Active Power DMD MAX (-P2DMDMAX) - Previous Week	03 / 04	-	mW	4058	4	E038	2
Timestamp in Compact BCD	03 / 04	-	10ms	405C	4	E03A	4
Phase 2 Pos. Active Power DMD MAX (+P2DMDMAX) - Previous Week	03 / 04	-	mW	4060	4	E03E	2
Timestamp in Compact BCD	03 / 04	-	10ms	4064	4	E040	4
Phase 2 Neg. Active Power DMD MAX (-P2DMDMAX) - Actual Week	03 / 04	-	mW	4068	4	E044	2
Timestamp in Compact BCD	03 / 04	-	10ms	406C	4	E046	4
Phase 2 Pos. Active Power DMD MAX (+P2DMDMAX) - Actual Week	03 / 04	-	mW	4070	4	E04A	2
Timestamp in Compact BCD	03 / 04	-	10ms	4074	4	E04C	4
Phase 2 Neg. Active Power DMD MAX (-P2DMDMAX) - Previous Day	03 / 04	-	mW	4078	4	E050	2
Timestamp in Compact BCD	03 / 04	-	10ms	407C	4	E052	4
Phase 2 Pos. Active Power DMD MAX (+P2DMDMAX) - Previous Day	03 / 04	-	mW	4080	4	E056	2
Timestamp in Compact BCD	03 / 04	-	10ms	4084	4	E058	4
Phase 2 Neg. Active Power DMD MAX (-P2DMDMAX) - Actual Day	03 / 04	-	mW	4088	4	E05C	2
Timestamp in Compact BCD	03 / 04	-	10ms	408C	4	E05E	4
Phase 2 Pos. Active Power DMD MAX (+P2DMDMAX) - Actual Day	03 / 04	-	mW	4090	4	E062	2
Timestamp in Compact BCD	03 / 04	-	10ms	4094	4	E064	4
Phase 3 Neg. Active Power DMD MAX (-P3DMDMAX) - Previous Month	03 / 04	-	mW	4098	4	E068	2
Timestamp in Compact BCD	03 / 04	-	10ms	409C	4	E06A	4
Phase 3 Pos. Active Power DMD MAX (+P3DMDMAX) - Previous Month	03 / 04	-	mW	40A0	4	E06E	2
Timestamp in Compact BCD	03 / 04	-	10ms	40A4	4	E070	4
Phase 3 Neg. Active Power DMD MAX (-P3DMDMAX) - Actual Month	03 / 04	-	mW	40A8	4	E074	2
Timestamp in Compact BCD	03 / 04	-	10ms	40AC	4	E076	4
Phase 3 Pos. Active Power DMD MAX (+P3DMDMAX) - Actual Month	03 / 04	-	mW	40B0	4	E07A	2
Timestamp in Compact BCD	03 / 04	-	10ms	40B4	4	E07C	4
Phase 3 Neg. Active Power DMD MAX (-P3DMDMAX) - Previous Week	03 / 04	-	mW	40B8	4	E080	2
Timestamp in Compact BCD	03 / 04	-	10ms	40BC	4	E082	4
Phase 3 Pos. Active Power DMD MAX (+P3DMDMAX) - Previous Week	03 / 04	-	mW	40C0	4	E086	2
Timestamp in Compact BCD	03 / 04	-	10ms	40C4	4	E088	4
Phase 3 Neg. Active Power DMD MAX (-P3DMDMAX) - Actual Week	03 / 04	-	mW	40C8	4	E08C	2
Timestamp in Compact BCD	03 / 04	-	10ms	40CC	4	E08E	4
Phase 3 Pos. Active Power DMD MAX (+P3DMDMAX) - Actual Week	03 / 04	-	mW	40D0	4	E092	2
Timestamp in Compact BCD	03 / 04	-	10ms	40D4	4	E094	4
Phase 3 Neg. Active Power DMD MAX (-P3DMDMAX) - Previous Day	03 / 04	-	mW	40D8	4	E098	2
Timestamp in Compact BCD	03 / 04	-	10ms	40DC	4	E09A	4
Phase 3 Pos. Active Power DMD MAX (+P3DMDMAX) - Previous Day	03 / 04	-	mW	40E0	4	E09E	2
Timestamp in Compact BCD	03 / 04	-	10ms	40E4	4	E0A0	4
Phase 3 Neg. Active Power DMD MAX (-P3DMDMAX) - Actual Day	03 / 04	-	mW	40E8	4	E0A4	2
Timestamp in Compact BCD	03 / 04	-	10ms	40EC	4	E0A6	4

Parameter	F. code (Hex)	Sign	M.U.	INTEGER		IEEE	
				Register (Hex)	Words	Register (Hex)	Words
Phase 3 Pos. Active Power DMD MAX (+P3DMDMAX) - Actual Day	03 / 04	-	mW	40F0	4	E0AA	2
Timestamp in Compact BCD	03 / 04	-	10ms	40F4	4	E0AC	4
System Neg. Active Power DMD MAX (-PΣDMDMAX) - Previous Month	03 / 04	-	mW	40F8	4	E0B0	2
Timestamp in Compact BCD	03 / 04	-	10ms	40FC	4	E0B2	4
System Pos. Active Power DMD MAX (+PΣDMDMAX) - Previous Month	03 / 04	-	mW	4100	4	E0B6	2
Timestamp in Compact BCD	03 / 04	-	10ms	4104	4	E0B8	4
System Neg. Active Power DMD MAX (-PΣDMDMAX) - Actual Month	03 / 04	-	mW	4108	4	E0BC	2
Timestamp in Compact BCD	03 / 04	-	10ms	410C	4	E0BE	4
System Pos. Active Power DMD MAX (+PΣDMDMAX) - Actual Month	03 / 04	-	mW	4110	4	E0C2	2
Timestamp in Compact BCD	03 / 04	-	10ms	4114	4	E0C4	4
System Neg. Active Power DMD MAX (-PΣDMDMAX) - Previous Week	03 / 04	-	mW	4118	4	E0C8	2
Timestamp in Compact BCD	03 / 04	-	10ms	411C	4	E0CA	4
System Pos. Active Power DMD MAX (+PΣDMDMAX) - Previous Week	03 / 04	-	mW	4120	4	E0CE	2
Timestamp in Compact BCD	03 / 04	-	10ms	4124	4	E0D0	4
System Neg. Active Power DMD MAX (-PΣDMDMAX) - Actual Week	03 / 04	-	mW	4128	4	E0D4	2
Timestamp in Compact BCD	03 / 04	-	10ms	412C	4	E0D6	4
System Pos. Active Power DMD MAX (+PΣDMDMAX) - Actual Week	03 / 04	-	mW	4130	4	E0DA	2
Timestamp in Compact BCD	03 / 04	-	10ms	4134	4	E0DC	4
System Neg. Active Power DMD MAX (-PΣDMDMAX) - Previous Day	03 / 04	-	mW	4138	4	E0E0	2
Timestamp in Compact BCD	03 / 04	-	10ms	413C	4	E0E2	4
System Pos. Active Power DMD MAX (+PΣDMDMAX) - Previous Day	03 / 04	-	mW	4140	4	E0E6	2
Timestamp in Compact BCD	03 / 04	-	10ms	4144	4	E0E8	4
System Neg. Active Power DMD MAX (-PΣDMDMAX) - Actual Day	03 / 04	-	mW	4148	4	E0EC	2
Timestamp in Compact BCD	03 / 04	-	10ms	414C	4	E0EE	4
System Pos. Active Power DMD MAX (+PΣDMDMAX) - Actual Day	03 / 04	-	mW	4150	4	E0F2	2
Timestamp in Compact BCD	03 / 04	-	10ms	4154	4	E0F4	4
Phase 1 Neg. Reactive Power DMD MAX (-Q1DMDMAX) - Previous Month	03 / 04	-	mvar	4158	4	E0F8	2
Timestamp in Compact BCD	03 / 04	-	10ms	415C	4	E0FA	4
Phase 1 Pos. Reactive Power DMD MAX (+Q1DMDMAX) - Previous Month	03 / 04	-	mvar	4160	4	E0FE	2
Timestamp in Compact BCD	03 / 04	-	10ms	4164	4	E100	4
Phase 1 Neg. Reactive Power DMD MAX (-Q1DMDMAX) - Actual Month	03 / 04	-	mvar	4168	4	E104	2
Timestamp in Compact BCD	03 / 04	-	10ms	416C	4	E106	4
Phase 1 Pos. Reactive Power DMD MAX (+Q1DMDMAX) - Actual Month	03 / 04	-	mvar	4170	4	E10A	2
Timestamp in Compact BCD	03 / 04	-	10ms	4174	4	E10C	4
Phase 1 Neg. Reactive Power DMD MAX (-Q1DMDMAX) - Previous Week	03 / 04	-	mvar	4178	4	E110	2
Timestamp in Compact BCD	03 / 04	-	10ms	417C	4	E112	4
Phase 1 Pos. Reactive Power DMD MAX (+Q1DMDMAX) - Previous Week	03 / 04	-	mvar	4180	4	E116	2
Timestamp in Compact BCD	03 / 04	-	10ms	4184	4	E118	4
Phase 1 Neg. Reactive Power DMD MAX (-Q1DMDMAX) - Actual Week	03 / 04	-	mvar	4188	4	E11C	2
Timestamp in Compact BCD	03 / 04	-	10ms	418C	4	E11E	4
Phase 1 Pos. Reactive Power DMD MAX (+Q1DMDMAX) - Actual Week	03 / 04	-	mvar	4190	4	E122	2
Timestamp in Compact BCD	03 / 04	-	10ms	4194	4	E124	4
Phase 1 Neg. Reactive Power DMD MAX (-Q1DMDMAX) - Previous Day	03 / 04	-	mvar	4198	4	E128	2
Timestamp in Compact BCD	03 / 04	-	10ms	419C	4	E12A	4
Phase 1 Pos. Reactive Power DMD MAX (+Q1DMDMAX) - Previous Day	03 / 04	-	mvar	41A0	4	E12E	2
Timestamp in Compact BCD	03 / 04	-	10ms	41A4	4	E130	4
Phase 1 Neg. Reactive Power DMD MAX (-Q1DMDMAX) - Actual Day	03 / 04	-	mvar	41A8	4	E134	2
Timestamp in Compact BCD	03 / 04	-	10ms	41AC	4	E136	4
Phase 1 Pos. Reactive Power DMD MAX (+Q1DMDMAX) - Actual Day	03 / 04	-	mvar	41B0	4	E13A	2
Timestamp in Compact BCD	03 / 04	-	10ms	41B4	4	E13C	4
Phase 2 Neg. Reactive Power DMD MAX (-Q2DMDMAX) - Previous Month	03 / 04	-	mvar	41B8	4	E140	2

Parameter	F. code (Hex)	Sign	M.U.	INTEGER		IEEE	
				Register (Hex)	Words	Register (Hex)	Words
Timestamp in Compact BCD	03 / 04	-	10ms	41BC	4	E142	4
Phase 2 Pos. Reactive Power DMD MAX (+Q2DMDMAX) - Previous Month	03 / 04	-	mvar	41C0	4	E146	2
Timestamp in Compact BCD	03 / 04	-	10ms	41C4	4	E148	4
Phase 2 Neg. Reactive Power DMD MAX (-Q2DMDMAX) - Actual Month	03 / 04	-	mvar	41C8	4	E14C	2
Timestamp in Compact BCD	03 / 04	-	10ms	41CC	4	E14E	4
Phase 2 Pos. Reactive Power DMD MAX (+Q2DMDMAX) - Actual Month	03 / 04	-	mvar	41D0	4	E152	2
Timestamp in Compact BCD	03 / 04	-	10ms	41D4	4	E154	4
Phase 2 Neg. Reactive Power DMD MAX (-Q2DMDMAX) - Previous Week	03 / 04	-	mvar	41D8	4	E158	2
Timestamp in Compact BCD	03 / 04	-	10ms	41DC	4	E15A	4
Phase 2 Pos. Reactive Power DMD MAX (+Q2DMDMAX) - Previous Week	03 / 04	-	mvar	41E0	4	E15E	2
Timestamp in Compact BCD	03 / 04	-	10ms	41E4	4	E160	4
Phase 2 Neg. Reactive Power DMD MAX (-Q2DMDMAX) - Actual Week	03 / 04	-	mvar	41E8	4	E164	2
Timestamp in Compact BCD	03 / 04	-	10ms	41EC	4	E166	4
Phase 2 Pos. Reactive Power DMD MAX (+Q2DMDMAX) - Actual Week	03 / 04	-	mvar	41F0	4	E16A	2
Timestamp in Compact BCD	03 / 04	-	10ms	41F4	4	E16C	4
Phase 2 Neg. Reactive Power DMD MAX (-Q2DMDMAX) - Previous Day	03 / 04	-	mvar	41F8	4	E170	2
Timestamp in Compact BCD	03 / 04	-	10ms	41FC	4	E172	4
Phase 2 Pos. Reactive Power DMD MAX (+Q2DMDMAX) - Previous Day	03 / 04	-	mvar	4200	4	E176	2
Timestamp in Compact BCD	03 / 04	-	10ms	4204	4	E178	4
Phase 2 Neg. Reactive Power DMD MAX (-Q2DMDMAX) - Actual Day	03 / 04	-	mvar	4208	4	E17C	2
Timestamp in Compact BCD	03 / 04	-	10ms	420C	4	E17E	4
Phase 2 Pos. Reactive Power DMD MAX (+Q2DMDMAX) - Actual Day	03 / 04	-	mvar	4210	4	E182	2
Timestamp in Compact BCD	03 / 04	-	10ms	4214	4	E184	4
Phase 3 Neg. Reactive Power DMD MAX (-Q3DMDMAX) - Previous Month	03 / 04	-	mvar	4218	4	E188	2
Timestamp in Compact BCD	03 / 04	-	10ms	421C	4	E18A	4
Phase 3 Pos. Reactive Power DMD MAX (+Q3DMDMAX) - Previous Month	03 / 04	-	mvar	4220	4	E18E	2
Timestamp in Compact BCD	03 / 04	-	10ms	4224	4	E190	4
Phase 3 Neg. Reactive Power DMD MAX (-Q3DMDMAX) - Actual Month	03 / 04	-	mvar	4228	4	E194	2
Timestamp in Compact BCD	03 / 04	-	10ms	422C	4	E196	4
Phase 3 Pos. Reactive Power DMD MAX (+Q3DMDMAX) - Actual Month	03 / 04	-	mvar	4230	4	E19A	2
Timestamp in Compact BCD	03 / 04	-	10ms	4234	4	E19C	4
Phase 3 Neg. Reactive Power DMD MAX (-Q3DMDMAX) - Previous Week	03 / 04	-	mvar	4238	4	E1A0	2
Timestamp in Compact BCD	03 / 04	-	10ms	423C	4	E1A2	4
Phase 3 Pos. Reactive Power DMD MAX (+Q3DMDMAX) - Previous Week	03 / 04	-	mvar	4240	4	E1A6	2
Timestamp in Compact BCD	03 / 04	-	10ms	4244	4	E1A8	4
Phase 3 Neg. Reactive Power DMD MAX (-Q3DMDMAX) - Actual Week	03 / 04	-	mvar	4248	4	E1AC	2
Timestamp in Compact BCD	03 / 04	-	10ms	424C	4	E1AE	4
Phase 3 Pos. Reactive Power DMD MAX (+Q3DMDMAX) - Actual Week	03 / 04	-	mvar	4250	4	E1B2	2
Timestamp in Compact BCD	03 / 04	-	10ms	4254	4	E1B4	4
Phase 3 Neg. Reactive Power DMD MAX (-Q3DMDMAX) - Previous Day	03 / 04	-	mvar	4258	4	E1B8	2
Timestamp in Compact BCD	03 / 04	-	10ms	425C	4	E1BA	4
Phase 3 Pos. Reactive Power DMD MAX (+Q3DMDMAX) - Previous Day	03 / 04	-	mvar	4260	4	E1BE	2
Timestamp in Compact BCD	03 / 04	-	10ms	4264	4	E1C0	4
Phase 3 Neg. Reactive Power DMD MAX (-Q3DMDMAX) - Actual Day	03 / 04	-	mvar	4268	4	E1C4	2
Timestamp in Compact BCD	03 / 04	-	10ms	426C	4	E1C6	4
Phase 3 Pos. Reactive Power DMD MAX (+Q3DMDMAX) - Actual Day	03 / 04	-	mvar	4270	4	E1CA	2
Timestamp in Compact BCD	03 / 04	-	10ms	4274	4	E1CC	4
System Neg. Reactive Power DMD MAX (-Q Σ DMDMAX) - Previous Month	03 / 04	-	mvar	4278	4	E1D0	2
Timestamp in Compact BCD	03 / 04	-	10ms	427C	4	E1D2	4
System Pos. Reactive Power DMD MAX (+Q Σ DMDMAX) - Previous Month	03 / 04	-	mvar	4280	4	E1D6	2
Timestamp in Compact BCD	03 / 04	-	10ms	4284	4	E1D8	4

Parameter	F. code (Hex)	Sign	M.U.	INTEGER		IEEE	
				Register (Hex)	Words	Register (Hex)	Words
System Neg. Reactive Power DMD MAX (-Q Σ DMDMAX) - Actual Month Timestamp in Compact BCD	03 / 04	-	mvar	4288	4	E1DC	2
System Pos. Reactive Power DMD MAX (+Q Σ DMDMAX) - Actual Month Timestamp in Compact BCD	03 / 04	-	10ms	428C	4	E1DE	4
System Neg. Reactive Power DMD MAX (-Q Σ DMDMAX) - Actual Month Timestamp in Compact BCD	03 / 04	-	mvar	4290	4	E1E2	2
System Pos. Reactive Power DMD MAX (+Q Σ DMDMAX) - Actual Month Timestamp in Compact BCD	03 / 04	-	10ms	4294	4	E1E4	4
System Neg. Reactive Power DMD MAX (-Q Σ DMDMAX) - Previous Week Timestamp in Compact BCD	03 / 04	-	mvar	4298	4	E1E8	2
System Pos. Reactive Power DMD MAX (+Q Σ DMDMAX) - Previous Week Timestamp in Compact BCD	03 / 04	-	10ms	429C	4	E1EA	4
System Neg. Reactive Power DMD MAX (-Q Σ DMDMAX) - Previous Week Timestamp in Compact BCD	03 / 04	-	mvar	42A0	4	E1EE	2
System Pos. Reactive Power DMD MAX (+Q Σ DMDMAX) - Previous Week Timestamp in Compact BCD	03 / 04	-	10ms	42A4	4	E1F0	4
System Neg. Reactive Power DMD MAX (-Q Σ DMDMAX) - Actual Week Timestamp in Compact BCD	03 / 04	-	mvar	42A8	4	E1F4	2
System Pos. Reactive Power DMD MAX (+Q Σ DMDMAX) - Actual Week Timestamp in Compact BCD	03 / 04	-	10ms	42AC	4	E1F6	4
System Neg. Reactive Power DMD MAX (-Q Σ DMDMAX) - Actual Week Timestamp in Compact BCD	03 / 04	-	mvar	42B0	4	E1FA	2
System Pos. Reactive Power DMD MAX (+Q Σ DMDMAX) - Actual Week Timestamp in Compact BCD	03 / 04	-	10ms	42B4	4	E1FC	4
System Neg. Reactive Power DMD MAX (-Q Σ DMDMAX) - Previous Day Timestamp in Compact BCD	03 / 04	-	mvar	42B8	4	E200	2
System Pos. Reactive Power DMD MAX (+Q Σ DMDMAX) - Previous Day Timestamp in Compact BCD	03 / 04	-	10ms	42BC	4	E202	4
System Neg. Reactive Power DMD MAX (-Q Σ DMDMAX) - Previous Day Timestamp in Compact BCD	03 / 04	-	mvar	42C0	4	E206	2
System Pos. Reactive Power DMD MAX (+Q Σ DMDMAX) - Previous Day Timestamp in Compact BCD	03 / 04	-	10ms	42C4	4	E208	4
System Neg. Reactive Power DMD MAX (-Q Σ DMDMAX) - Actual Day Timestamp in Compact BCD	03 / 04	-	mvar	42C8	4	E20C	2
System Pos. Reactive Power DMD MAX (+Q Σ DMDMAX) - Actual Day Timestamp in Compact BCD	03 / 04	-	10ms	42CC	4	E20E	4
System Neg. Reactive Power DMD MAX (-Q Σ DMDMAX) - Actual Day Timestamp in Compact BCD	03 / 04	-	mvar	42D0	4	E212	2
System Pos. Reactive Power DMD MAX (+Q Σ DMDMAX) - Actual Day Timestamp in Compact BCD	03 / 04	-	10ms	42D4	4	E214	4
Phase 1 Neg. Apparent Power DMD MAX (-S1DMDMAX) - Previous Month Timestamp in Compact BCD	03 / 04	-	mVA	42D8	4	E218	2
Phase 1 Pos. Apparent Power DMD MAX (+S1DMDMAX) - Previous Month Timestamp in Compact BCD	03 / 04	-	10ms	42DC	4	E21A	4
Phase 1 Neg. Apparent Power DMD MAX (-S1DMDMAX) - Previous Month Timestamp in Compact BCD	03 / 04	-	mVA	42E0	4	E21E	2
Phase 1 Pos. Apparent Power DMD MAX (+S1DMDMAX) - Previous Month Timestamp in Compact BCD	03 / 04	-	10ms	42E4	4	E220	4
Phase 1 Neg. Apparent Power DMD MAX (-S1DMDMAX) - Actual Month Timestamp in Compact BCD	03 / 04	-	mVA	42E8	4	E224	2
Phase 1 Pos. Apparent Power DMD MAX (+S1DMDMAX) - Actual Month Timestamp in Compact BCD	03 / 04	-	10ms	42EC	4	E226	4
Phase 1 Neg. Apparent Power DMD MAX (-S1DMDMAX) - Actual Month Timestamp in Compact BCD	03 / 04	-	mVA	42F0	4	E22A	2
Phase 1 Pos. Apparent Power DMD MAX (+S1DMDMAX) - Actual Month Timestamp in Compact BCD	03 / 04	-	10ms	42F4	4	E22C	4
Phase 1 Neg. Apparent Power DMD MAX (-S1DMDMAX) - Previous Week Timestamp in Compact BCD	03 / 04	-	mVA	42F8	4	E230	2
Phase 1 Pos. Apparent Power DMD MAX (+S1DMDMAX) - Previous Week Timestamp in Compact BCD	03 / 04	-	10ms	42FC	4	E232	4
Phase 1 Neg. Apparent Power DMD MAX (-S1DMDMAX) - Previous Week Timestamp in Compact BCD	03 / 04	-	mVA	4300	4	E236	2
Phase 1 Pos. Apparent Power DMD MAX (+S1DMDMAX) - Previous Week Timestamp in Compact BCD	03 / 04	-	10ms	4304	4	E238	4
Phase 1 Neg. Apparent Power DMD MAX (-S1DMDMAX) - Actual Week Timestamp in Compact BCD	03 / 04	-	mVA	4308	4	E23C	2
Phase 1 Pos. Apparent Power DMD MAX (+S1DMDMAX) - Actual Week Timestamp in Compact BCD	03 / 04	-	10ms	430C	4	E23E	4
Phase 1 Neg. Apparent Power DMD MAX (-S1DMDMAX) - Actual Week Timestamp in Compact BCD	03 / 04	-	mVA	4310	4	E242	2
Phase 1 Pos. Apparent Power DMD MAX (+S1DMDMAX) - Actual Week Timestamp in Compact BCD	03 / 04	-	10ms	4314	4	E244	4
Phase 1 Neg. Apparent Power DMD MAX (-S1DMDMAX) - Previous Day Timestamp in Compact BCD	03 / 04	-	mVA	4318	4	E248	2
Phase 1 Pos. Apparent Power DMD MAX (+S1DMDMAX) - Previous Day Timestamp in Compact BCD	03 / 04	-	10ms	431C	4	E24A	4
Phase 1 Neg. Apparent Power DMD MAX (-S1DMDMAX) - Previous Day Timestamp in Compact BCD	03 / 04	-	mVA	4320	4	E24E	2
Phase 1 Pos. Apparent Power DMD MAX (+S1DMDMAX) - Previous Day Timestamp in Compact BCD	03 / 04	-	10ms	4324	4	E250	4
Phase 1 Neg. Apparent Power DMD MAX (-S1DMDMAX) - Actual Day Timestamp in Compact BCD	03 / 04	-	mVA	4328	4	E254	2
Phase 1 Pos. Apparent Power DMD MAX (+S1DMDMAX) - Actual Day Timestamp in Compact BCD	03 / 04	-	10ms	432C	4	E256	4
Phase 1 Neg. Apparent Power DMD MAX (-S1DMDMAX) - Actual Day Timestamp in Compact BCD	03 / 04	-	mVA	4330	4	E25A	2
Phase 1 Pos. Apparent Power DMD MAX (+S1DMDMAX) - Actual Day Timestamp in Compact BCD	03 / 04	-	10ms	4334	4	E25C	4
Phase 2 Neg. Apparent Power DMD MAX (-S2DMDMAX) - Previous Month Timestamp in Compact BCD	03 / 04	-	mVA	4338	4	E260	2
Phase 2 Pos. Apparent Power DMD MAX (+S2DMDMAX) - Previous Month Timestamp in Compact BCD	03 / 04	-	10ms	433C	4	E262	4
Phase 2 Neg. Apparent Power DMD MAX (-S2DMDMAX) - Previous Month Timestamp in Compact BCD	03 / 04	-	mVA	4340	4	E266	2
Phase 2 Pos. Apparent Power DMD MAX (+S2DMDMAX) - Previous Month Timestamp in Compact BCD	03 / 04	-	10ms	4344	4	E268	4
Phase 2 Neg. Apparent Power DMD MAX (-S2DMDMAX) - Actual Month Timestamp in Compact BCD	03 / 04	-	mVA	4348	4	E26C	2
Phase 2 Pos. Apparent Power DMD MAX (+S2DMDMAX) - Actual Month Timestamp in Compact BCD	03 / 04	-	10ms	434C	4	E26E	4
Phase 2 Neg. Apparent Power DMD MAX (-S2DMDMAX) - Actual Month Timestamp in Compact BCD	03 / 04	-	mVA	4350	4	E272	2

Parameter	F. code (Hex)	Sign	M.U.	INTEGER		IEEE	
				Register (Hex)	Words	Register (Hex)	Words
Timestamp in Compact BCD	03 / 04	-	10ms	4354	4	E274	4
Phase 2 Neg. Apparent Power DMD MAX (-S2DMDMAX) - Previous Week	03 / 04	-	mVA	4358	4	E278	2
Timestamp in Compact BCD	03 / 04	-	10ms	435C	4	E27A	4
Phase 2 Pos. Apparent Power DMD MAX (+S2DMDMAX) - Previous Week	03 / 04	-	mVA	4360	4	E27E	2
Timestamp in Compact BCD	03 / 04	-	10ms	4364	4	E280	4
Phase 2 Neg. Apparent Power DMD MAX (-S2DMDMAX) - Actual Week	03 / 04	-	mVA	4368	4	E284	2
Timestamp in Compact BCD	03 / 04	-	10ms	436C	4	E286	4
Phase 2 Pos. Apparent Power DMD MAX (+S2DMDMAX) - Actual Week	03 / 04	-	mVA	4370	4	E28A	2
Timestamp in Compact BCD	03 / 04	-	10ms	4374	4	E28C	4
Phase 2 Neg. Apparent Power DMD MAX (-S2DMDMAX) - Previous Day	03 / 04	-	mVA	4378	4	E290	2
Timestamp in Compact BCD	03 / 04	-	10ms	437C	4	E292	4
Phase 2 Pos. Apparent Power DMD MAX (+S2DMDMAX) - Previous Day	03 / 04	-	mVA	4380	4	E296	2
Timestamp in Compact BCD	03 / 04	-	10ms	4384	4	E298	4
Phase 2 Neg. Apparent Power DMD MAX (-S2DMDMAX) - Actual Day	03 / 04	-	mVA	4388	4	E29C	2
Timestamp in Compact BCD	03 / 04	-	10ms	438C	4	E29E	4
Phase 2 Pos. Apparent Power DMD MAX (+S2DMDMAX) - Actual Day	03 / 04	-	mVA	4390	4	E2A2	2
Timestamp in Compact BCD	03 / 04	-	10ms	4394	4	E2A4	4
Phase 3 Neg. Apparent Power DMD MAX (-S3DMDMAX) - Previous Month	03 / 04	-	mVA	4398	4	E2A8	2
Timestamp in Compact BCD	03 / 04	-	10ms	439C	4	E2AA	4
Phase 3 Pos. Apparent Power DMD MAX (+S3DMDMAX) - Previous Month	03 / 04	-	mVA	43A0	4	E2AE	2
Timestamp in Compact BCD	03 / 04	-	10ms	43A4	4	E2B0	4
Phase 3 Neg. Apparent Power DMD MAX (-S3DMDMAX) - Actual Month	03 / 04	-	mVA	43A8	4	E2B4	2
Timestamp in Compact BCD	03 / 04	-	10ms	43AC	4	E2B6	4
Phase 3 Pos. Apparent Power DMD MAX (+S3DMDMAX) - Actual Month	03 / 04	-	mVA	43B0	4	E2BA	2
Timestamp in Compact BCD	03 / 04	-	10ms	43B4	4	E2BC	4
Phase 3 Neg. Apparent Power DMD MAX (-S3DMDMAX) - Previous Week	03 / 04	-	mVA	43B8	4	E2C0	2
Timestamp in Compact BCD	03 / 04	-	10ms	43BC	4	E2C2	4
Phase 3 Pos. Apparent Power DMD MAX (+S3DMDMAX) - Previous Week	03 / 04	-	mVA	43C0	4	E2C6	2
Timestamp in Compact BCD	03 / 04	-	10ms	43C4	4	E2C8	4
Phase 3 Neg. Apparent Power DMD MAX (-S3DMDMAX) - Actual Week	03 / 04	-	mVA	43C8	4	E2CC	2
Timestamp in Compact BCD	03 / 04	-	10ms	43CC	4	E2CE	4
Phase 3 Pos. Apparent Power DMD MAX (+S3DMDMAX) - Actual Week	03 / 04	-	mVA	43D0	4	E2D2	2
Timestamp in Compact BCD	03 / 04	-	10ms	43D4	4	E2D4	4
Phase 3 Neg. Apparent Power DMD MAX (-S3DMDMAX) - Previous Day	03 / 04	-	mVA	43D8	4	E2D8	2
Timestamp in Compact BCD	03 / 04	-	10ms	43DC	4	E2DA	4
Phase 3 Pos. Apparent Power DMD MAX (+S3DMDMAX) - Previous Day	03 / 04	-	mVA	43E0	4	E2DE	2
Timestamp in Compact BCD	03 / 04	-	10ms	43E4	4	E2E0	4
Phase 3 Neg. Apparent Power DMD MAX (-S3DMDMAX) - Actual Day	03 / 04	-	mVA	43E8	4	E2E4	2
Timestamp in Compact BCD	03 / 04	-	10ms	43EC	4	E2E6	4
Phase 3 Pos. Apparent Power DMD MAX (+S3DMDMAX) - Actual Day	03 / 04	-	mVA	43F0	4	E2EA	2
Timestamp in Compact BCD	03 / 04	-	10ms	43F4	4	E2EC	4
System Neg. Apparent Power DMD MAX (-S Σ DMDMAX) - Previous Month	03 / 04	-	mVA	43F8	4	E2F0	2
Timestamp in Compact BCD	03 / 04	-	10ms	43FC	4	E2F2	4
System Pos. Apparent Power DMD MAX (+S Σ DMDMAX) - Previous Month	03 / 04	-	mVA	4400	4	E2F6	2
Timestamp in Compact BCD	03 / 04	-	10ms	4404	4	E2F8	4
System Neg. Apparent Power DMD MAX (-S Σ DMDMAX) - Actual Month	03 / 04	-	mVA	4408	4	E2FC	2
Timestamp in Compact BCD	03 / 04	-	10ms	440C	4	E2FE	4
System Pos. Apparent Power DMD MAX (+S Σ DMDMAX) - Actual Month	03 / 04	-	mVA	4410	4	E302	2
Timestamp in Compact BCD	03 / 04	-	10ms	4414	4	E304	4
System Neg. Apparent Power DMD MAX (-S Σ DMDMAX) - Previous Week	03 / 04	-	mVA	4418	4	E308	2
Timestamp in Compact BCD	03 / 04	-	10ms	441C	4	E30A	4

Parameter	F. code (Hex)	Sign	M.U.	INTEGER		IEEE	
				Register (Hex)	Words	Register (Hex)	Words
System Pos. Apparent Power DMD MAX (+S Σ DMDMAX) - Previous Week	03 / 04	-	mVA	4420	4	E30E	2
Timestamp in Compact BCD	03 / 04	-	10ms	4424	4	E310	4
System Neg. Apparent Power DMD MAX (-S Σ DMDMAX) - Actual Week	03 / 04	-	mVA	4428	4	E314	2
Timestamp in Compact BCD	03 / 04	-	10ms	442C	4	E316	4
System Pos. Apparent Power DMD MAX (+S Σ DMDMAX) - Actual Week	03 / 04	-	mVA	4430	4	E31A	2
Timestamp in Compact BCD	03 / 04	-	10ms	4434	4	E31C	4
System Neg. Apparent Power DMD MAX (-S Σ DMDMAX) - Previous Day	03 / 04	-	mVA	4438	4	E320	2
Timestamp in Compact BCD	03 / 04	-	10ms	443C	4	E322	4
System Pos. Apparent Power DMD MAX (+S Σ DMDMAX) - Previous Day	03 / 04	-	mVA	4440	4	E326	2
Timestamp in Compact BCD	03 / 04	-	10ms	4444	4	E328	4
System Neg. Apparent Power DMD MAX (-S Σ DMDMAX) - Actual Day	03 / 04	-	mVA	4448	4	E32C	2
Timestamp in Compact BCD	03 / 04	-	10ms	444C	4	E32E	4
System Pos. Apparent Power DMD MAX (+S Σ DMDMAX) - Actual Day	03 / 04	-	mVA	4450	4	E332	2
Timestamp in Compact BCD	03 / 04	-	10ms	4454	4	E334	4
Phase 1 Neg.TruePow.Factor DMD MAX (-TPF1DMDMAX) - Previous Month	03 / 04	-	0,001	4458	2	E338	2
Timestamp in Compact BCD	03 / 04	-	10ms	445A	4	E33A	4
Phase 1 Pos.TruePow.Factor DMD MAX (+TPF1DMDMAX) - Previous Month	03 / 04	-	0,001	445E	2	E33E	2
Timestamp in Compact BCD	03 / 04	-	10ms	4460	4	E340	4
Phase 1 Neg.TruePow.Factor DMD MAX (-TPF1DMDMAX) - Actual Month	03 / 04	-	0,001	4464	2	E344	2
Timestamp in Compact BCD	03 / 04	-	10ms	4466	4	E346	4
Phase 1 Pos.TruePow.Factor DMD MAX (+TPF1DMDMAX) - Actual Month	03 / 04	-	0,001	446A	2	E34A	2
Timestamp in Compact BCD	03 / 04	-	10ms	446C	4	E34C	4
Phase 1 Neg.TruePow.Factor DMD MAX (-TPF1DMDMAX) - Previous Week	03 / 04	-	0,001	4470	2	E350	2
Timestamp in Compact BCD	03 / 04	-	10ms	4472	4	E352	4
Phase 1 Pos.TruePow.Factor DMD MAX (+TPF1DMDMAX) - Previous Week	03 / 04	-	0,001	4476	2	E356	2
Timestamp in Compact BCD	03 / 04	-	10ms	4478	4	E358	4
Phase 1 Neg.TruePow.Factor DMD MAX (-TPF1DMDMAX) - Actual Week	03 / 04	-	0,001	447C	2	E35C	2
Timestamp in Compact BCD	03 / 04	-	10ms	447E	4	E35E	4
Phase 1 Pos.TruePow.Factor DMD MAX (+TPF1DMDMAX) - Actual Week	03 / 04	-	0,001	4482	2	E362	2
Timestamp in Compact BCD	03 / 04	-	10ms	4484	4	E364	4
Phase 1 Neg.TruePow.Factor DMD MAX (-TPF1DMDMAX) - Previous Day	03 / 04	-	0,001	4488	2	E368	2
Timestamp in Compact BCD	03 / 04	-	10ms	448A	4	E36A	4
Phase 1 Pos.TruePow.Factor DMD MAX (+TPF1DMDMAX) - Previous Day	03 / 04	-	0,001	448E	2	E36E	2
Timestamp in Compact BCD	03 / 04	-	10ms	4490	4	E370	4
Phase 1 Neg.TruePow.Factor DMD MAX (-TPF1DMDMAX) - Actual Day	03 / 04	-	0,001	4494	2	E374	2
Timestamp in Compact BCD	03 / 04	-	10ms	4496	4	E376	4
Phase 1 Pos.TruePow.Factor DMD MAX (+TPF1DMDMAX) - Actual Day	03 / 04	-	0,001	449A	2	E37A	2
Timestamp in Compact BCD	03 / 04	-	10ms	449C	4	E37C	4
Phase 2 Neg.TruePow.Factor DMD MAX (-TPF2DMDMAX) - Previous Month	03 / 04	-	0,001	44A0	2	E380	2
Timestamp in Compact BCD	03 / 04	-	10ms	44A2	4	E382	4
Phase 2 Pos.TruePow.Factor DMD MAX (+TPF2DMDMAX) - Previous Month	03 / 04	-	0,001	44A6	2	E386	2
Timestamp in Compact BCD	03 / 04	-	10ms	44A8	4	E388	4
Phase 2 Neg.TruePow.Factor DMD MAX (-TPF2DMDMAX) - Actual Month	03 / 04	-	0,001	44AC	2	E38C	2
Timestamp in Compact BCD	03 / 04	-	10ms	44AE	4	E38E	4
Phase 2 Pos.TruePow.Factor DMD MAX (+TPF2DMDMAX) - Actual Month	03 / 04	-	0,001	44B2	2	E392	2
Timestamp in Compact BCD	03 / 04	-	10ms	44B4	4	E394	4
Phase 2 Neg.TruePow.Factor DMD MAX (-TPF2DMDMAX) - Previous Week	03 / 04	-	0,001	44B8	2	E398	2
Timestamp in Compact BCD	03 / 04	-	10ms	44BA	4	E39A	4
Phase 2 Pos.TruePow.Factor DMD MAX (+TPF2DMDMAX) - Previous Week	03 / 04	-	0,001	44BE	2	E39E	2
Timestamp in Compact BCD	03 / 04	-	10ms	44C0	4	E3A0	4
Phase 2 Neg.TruePow.Factor DMD MAX (-TPF2DMDMAX) - Actual Week	03 / 04	-	0,001	44C4	2	E3A4	2

Parameter	F. code (Hex)	Sign	M.U.	INTEGER		IEEE	
				Register (Hex)	Words	Register (Hex)	Words
Timestamp in Compact BCD	03 / 04	-	10ms	44C6	4	E3A6	4
Phase 2 Pos.TruePow.Factor DMD MAX (+TPF2DMDMAX) - Actual Week	03 / 04	-	0,001	44CA	2	E3AA	2
Timestamp in Compact BCD	03 / 04	-	10ms	44CC	4	E3AC	4
Phase 2 Neg.TruePow.Factor DMD MAX (-TPF2DMDMAX) - Previous Day	03 / 04	-	0,001	44D0	2	E3B0	2
Timestamp in Compact BCD	03 / 04	-	10ms	44D2	4	E3B2	4
Phase 2 Pos.TruePow.Factor DMD MAX (+TPF2DMDMAX) - Previous Day	03 / 04	-	0,001	44D6	2	E3B6	2
Timestamp in Compact BCD	03 / 04	-	10ms	44D8	4	E3B8	4
Phase 2 Neg.TruePow.Factor DMD MAX (-TPF2DMDMAX) - Actual Day	03 / 04	-	0,001	44DC	2	E3BC	2
Timestamp in Compact BCD	03 / 04	-	10ms	44DE	4	E3BE	4
Phase 2 Pos.TruePow.Factor DMD MAX (+TPF2DMDMAX) - Actual Day	03 / 04	-	0,001	44E2	2	E3C2	2
Timestamp in Compact BCD	03 / 04	-	10ms	44E4	4	E3C4	4
Phase 3 Neg.TruePow.Factor DMD MAX (-TPF3DMDMAX) - Previous Month	03 / 04	-	0,001	44E8	2	E3C8	2
Timestamp in Compact BCD	03 / 04	-	10ms	44EA	4	E3CA	4
Phase 3 Pos.TruePow.Factor DMD MAX (+TPF3DMDMAX) - Previous Month	03 / 04	-	0,001	44EE	2	E3CE	2
Timestamp in Compact BCD	03 / 04	-	10ms	44F0	4	E3D0	4
Phase 3 Neg.TruePow.Factor DMD MAX (-TPF3DMDMAX) - Actual Month	03 / 04	-	0,001	44F4	2	E3D4	2
Timestamp in Compact BCD	03 / 04	-	10ms	44F6	4	E3D6	4
Phase 3 Pos.TruePow.Factor DMD MAX (+TPF3DMDMAX) - Actual Month	03 / 04	-	0,001	44FA	2	E3DA	2
Timestamp in Compact BCD	03 / 04	-	10ms	44FC	4	E3DC	4
Phase 3 Neg.TruePow.Factor DMD MAX (-TPF3DMDMAX) - Previous Week	03 / 04	-	0,001	4500	2	E3E0	2
Timestamp in Compact BCD	03 / 04	-	10ms	4502	4	E3E2	4
Phase 3 Pos.TruePow.Factor DMD MAX (+TPF3DMDMAX) - Previous Week	03 / 04	-	0,001	4506	2	E3E6	2
Timestamp in Compact BCD	03 / 04	-	10ms	4508	4	E3E8	4
Phase 3 Neg.TruePow.Factor DMD MAX (-TPF3DMDMAX) - Actual Week	03 / 04	-	0,001	450C	2	E3EC	2
Timestamp in Compact BCD	03 / 04	-	10ms	450E	4	E3EE	4
Phase 3 Pos.TruePow.Factor DMD MAX (+TPF3DMDMAX) - Actual Week	03 / 04	-	0,001	4512	2	E3F2	2
Timestamp in Compact BCD	03 / 04	-	10ms	4514	4	E3F4	4
Phase 3 Neg.TruePow.Factor DMD MAX (-TPF3DMDMAX) - Previous Day	03 / 04	-	0,001	4518	2	E3F8	2
Timestamp in Compact BCD	03 / 04	-	10ms	451A	4	E3FA	4
Phase 3 Pos.TruePow.Factor DMD MAX (+TPF3DMDMAX) - Previous Day	03 / 04	-	0,001	451E	2	E3FE	2
Timestamp in Compact BCD	03 / 04	-	10ms	4520	4	E400	4
Phase 3 Neg.TruePow.Factor DMD MAX (-TPF3DMDMAX) - Actual Day	03 / 04	-	0,001	4524	2	E404	2
Timestamp in Compact BCD	03 / 04	-	10ms	4526	4	E406	4
Phase 3 Pos.TruePow.Factor DMD MAX (+TPF3DMDMAX) - Actual Day	03 / 04	-	0,001	452A	2	E40A	2
Timestamp in Compact BCD	03 / 04	-	10ms	452C	4	E40C	4
System Neg.TruePow.Factor DMD MAX (-TPF Σ DMDMAX) - Previous Month	03 / 04	-	0,001	4530	2	E410	2
Timestamp in Compact BCD	03 / 04	-	10ms	4532	4	E412	4
System Pos.TruePow.Factor DMD MAX (+TPF Σ DMDMAX) - Previous Month	03 / 04	-	0,001	4536	2	E416	2
Timestamp in Compact BCD	03 / 04	-	10ms	4538	4	E418	4
System Neg.TruePow.Factor DMD MAX (-TPF Σ DMDMAX) - Actual Month	03 / 04	-	0,001	453C	2	E41C	2
Timestamp in Compact BCD	03 / 04	-	10ms	453E	4	E41E	4
System Pos.TruePow.Factor DMD MAX (+TPF Σ DMDMAX) - Actual Month	03 / 04	-	0,001	4542	2	E422	2
Timestamp in Compact BCD	03 / 04	-	10ms	4544	4	E424	4
System Neg.TruePow.Factor DMD MAX (-TPF Σ DMDMAX) - Previous Week	03 / 04	-	0,001	4548	2	E428	2
Timestamp in Compact BCD	03 / 04	-	10ms	454A	4	E42A	4
System Pos.TruePow.Factor DMD MAX (+TPF Σ DMDMAX) - Previous Week	03 / 04	-	0,001	454E	2	E42E	2
Timestamp in Compact BCD	03 / 04	-	10ms	4550	4	E430	4
System Neg.TruePow.Factor DMD MAX (-TPF Σ DMDMAX) - Actual Week	03 / 04	-	0,001	4554	2	E434	2
Timestamp in Compact BCD	03 / 04	-	10ms	4556	4	E436	4
System Pos.TruePow.Factor DMD MAX (+TPF Σ DMDMAX) - Actual Week	03 / 04	-	0,001	455A	2	E43A	2
Timestamp in Compact BCD	03 / 04	-	10ms	455C	4	E43C	4

Parameter	F. code (Hex)	Sign	M.U.	INTEGER		IEEE	
				Register (Hex)	Words	Register (Hex)	Words
System Neg.TruePow.Factor DMD MAX (-TPF Σ DMDMAX) - Previous Day Timestamp in Compact BCD	03 / 04	-	0,001	4560	2	E440	2
System Pos.TruePow.Factor DMD MAX (+TPF Σ DMDMAX) - Previous Day Timestamp in Compact BCD	03 / 04	-	10ms	4562	4	E442	4
System Neg.TruePow.Factor DMD MAX (-TPF Σ DMDMAX) - Actual Day Timestamp in Compact BCD	03 / 04	-	0,001	4566	2	E446	2
System Pos.TruePow.Factor DMD MAX (+TPF Σ DMDMAX) - Actual Day Timestamp in Compact BCD	03 / 04	-	10ms	4568	4	E448	4
System Neg.TruePow.Factor DMD MAX (-TPF Σ DMDMAX) - Actual Day Timestamp in Compact BCD	03 / 04	-	0,001	456C	2	E44C	2
System Pos.TruePow.Factor DMD MAX (+TPF Σ DMDMAX) - Actual Day Timestamp in Compact BCD	03 / 04	-	10ms	456E	4	E44E	4
System Neg.TruePow.Factor DMD MAX (-TPF Σ DMDMAX) - Actual Day Timestamp in Compact BCD	03 / 04	-	0,001	4572	2	E452	2
System Pos.TruePow.Factor DMD MAX (+TPF Σ DMDMAX) - Actual Day Timestamp in Compact BCD	03 / 04	-	10ms	4574	4	E454	4

Parameter	F. code (Hex)	Sign	M.U.	INTEGER	
				Register (Hex)	Words

INPUTS & OUTPUTS STATUS

Digital Outputs Status - convert the Hex value in Binary value	03 / 04 / 06 / 10	-	-	F000	2
<p>LEGEND:</p> <p>bit3 = DO4 ... bit0(LSb) = DO1</p> <p>Bit = 0 means DO opened, not active</p> <p>Bit = 1 means DO closed, active</p> <p>Programmable/readable values and meaning:</p> <p>\$00 = 0000bin = DO1-2-3-4 not active</p> <p>\$01 = 0001bin = DO1 active, DO2-3-4 not active</p> <p>\$02 = 0010bin = DO2 active, DO1-3-4 not active</p> <p>\$03 = 0011bin = DO1-2 active, DO3-4 not active</p> <p>\$04 = 0100bin = DO3 active, DO1-2-4 not active</p> <p>\$05 = 0101bin = DO1-3 active, DO2-4 not active</p> <p>\$06 = 0110bin = DO2-3 active, DO1-4 not active</p> <p>\$07 = 0111bin = DO1-2-3 active, DO4 not active</p> <p>\$08 = 1000bin = DO4 active, DO1-2-3 not active</p> <p>\$09 = 1001bin = DO1-4 active, DO2-3 not active</p> <p>\$0A = 1010bin = DO2-4 active, DO1-3 not active</p> <p>\$0B = 1011bin = DO1-2-4 active, DO3 not active</p> <p>\$0C = 1100bin = DO3-4 active, DO1-2 not active</p> <p>\$0D = 1101bin = DO1-3-4 active, DO2 not active</p> <p>\$0E = 1110bin = DO2-3-4 active, DO1 not active</p> <p>\$0F = 1111bin = DO1-2-3-4 active</p>					
<p>WARNING! This command works only if DO was previously set in Modbus signalling mode by Web Server. If DO is set in Alarm, Pulse or None signalling mode, this command is not available.</p>					

Digital Input Status - convert the read Hex value in Binary value	03 / 04	-	-	F002	2
---	---------	---	---	------	---

LEGEND:
bit3 = DI4 ... bit0(LSb) = DI1
Bit = 0 means DI not active Bit = 1 means DI active

Readable values and meaning:
\$00 = 0000bin = DI1-2-3-4 not active
\$01 = 0001bin = DI1 active, DI2-3-4 not active
\$02 = 0010bin = DI2 active, DI1-3-4 not active
\$03 = 0011bin = DI1-2 active, DI3-4 not active
\$04 = 0100bin = DI3 active, DI1-2-4 not active
\$05 = 0101bin = DI1-3 active, DI2-4 not active
\$06 = 0110bin = DI2-3 active, DI1-4 not active
\$07 = 0111bin = DI1-2-3 active, DI4 not active
\$08 = 1000bin = DI4 active, DI1-2-3 not active
\$09 = 1001bin = DI1-4 active, DI2-3 not active
\$0A = 1010bin = DI2-4 active, DI1-3 not active
\$0B = 1011bin = DI1-2-4 active, DI3 not active
\$0C = 1100bin = DI3-4 active, DI1-2 not active
\$0D = 1101bin = DI1-3-4 active, DI2 not active
\$0E = 1110bin = DI2-3-4 active, DI1 not active
\$0F = 1111bin = DI1-2-3-4 active

Parameter	F. code (Hex)	M.U.	INTEGER		IEEE	
			Register (Hex)	Words	Register (Hex)	Words

VOLTAGE & CURRENT HARMONICS & INTERHARMONICS MAGNITUDE&PHASE - fnom=50 Hz

Set the parameter for the next reading command. Programmable data: \$01=Phase 1 to Neutral Voltage (U1N) \$02=Phase 2 to Neutral Voltage (U2N) \$03=Phase 3 to Neutral Voltage (U3N) \$04=Line 1 to 2 Voltage (U12) \$05=Line 2 to 3 Voltage (U23) \$06=Line 3 to 1 Voltage (U31) \$07=Phase 1 Current (I1) \$08=Phase 2 Current (I2) \$09=Phase 3 Current (I3)	10	-	0100	2	-	-
<u>Example</u> To read the Phase 1 current fundamental (1st) magnitude integer: 1. First send writing register 0100 by programming \$07 for parameter selection. 2. Then, send the reading register 0128.						
WARNING! The harmonic measuring unit changes according to the set display mode. If "Percentage" is set as display mode, the read harmonic magnitude will be in percentage values referred to the Fundamental. If "Absolute" is set as display mode, the read harmonic magnitude will be in absolute values (mV in case of voltage harmonics or mA in case of current harmonics).						
DC Component	03 / 04	0.001% / mV / mA	0102	2	B102	2
Interharmonic Group 0 - Bin 1 magnitude	03 / 04	0.001% / mV / mA	0104	2	B104	2
Interharmonic Group 0 - Bin 1 phase	03 / 04	0.001°	0106	2	B106	2
Interharmonic Group 0 - Bin 2 magnitude	03 / 04	0.001% / mV / mA	0108	2	B108	2
Interharmonic Group 0 - Bin 2 phase	03 / 04	0.001°	010A	2	B10A	2
Interharmonic Group 0 - Bin 3 magnitude	03 / 04	0.001% / mV / mA	010C	2	B10C	2
Interharmonic Group 0 - Bin 3 phase	03 / 04	0.001°	010E	2	B10E	2
Interharmonic Group 0 - Bin 4 magnitude	03 / 04	0.001% / mV / mA	0110	2	B110	2
Interharmonic Group 0 - Bin 4 phase	03 / 04	0.001°	0112	2	B112	2
Interharmonic Group 0 - Bin 5 magnitude	03 / 04	0.001% / mV / mA	0114	2	B114	2
Interharmonic Group 0 - Bin 5 phase	03 / 04	0.001°	0116	2	B116	2
Interharmonic Group 0 - Bin 6 magnitude	03 / 04	0.001% / mV / mA	0118	2	B118	2
Interharmonic Group 0 - Bin 6 phase	03 / 04	0.001°	011A	2	B11A	2

Parameter	F. code (Hex)	M.U.	INTEGER		IEEE	
			Register (Hex)	Words	Register (Hex)	Words
VOLTAGE & CURRENT HARMONICS & INTERHARMONICS MAGNITUDE&PHASE - fnom=50 Hz						
Interharmonic Group 0 - Bin 7 magnitude	03 / 04	0.001% / mV / mA	011C	2	B11C	2
Interharmonic Group 0 - Bin 7 phase	03 / 04	0.001°	011E	2	B11E	2
Interharmonic Group 0 - Bin 8 magnitude	03 / 04	0.001% / mV / mA	0120	2	B120	2
Interharmonic Group 0 - Bin 8 phase	03 / 04	0.001°	0122	2	B122	2
Interharmonic Group 0 - Bin 9 magnitude	03 / 04	0.001% / mV / mA	0124	2	B124	2
Interharmonic Group 0 - Bin 9 phase	03 / 04	0.001°	0126	2	B126	2
1st Harmonic Component - Magnitude	03 / 04	0.001% / mV / mA	0128	2	B128	2
1st Harmonic Component - Phase	03 / 04	0.001°	012A	2	B12A	2
Interharmonic Group 1 - Bin 1 magnitude	03 / 04	0.001% / mV / mA	012C	2	B12C	2
Interharmonic Group 1 - Bin 1 phase	03 / 04	0.001°	012E	2	B12E	2
Interharmonic Group 1 - Bin 2 magnitude	03 / 04	0.001% / mV / mA	0130	2	B130	2
Interharmonic Group 1 - Bin 2 phase	03 / 04	0.001°	0132	2	B132	2
Interharmonic Group 1 - Bin 3 magnitude	03 / 04	0.001% / mV / mA	0134	2	B134	2
Interharmonic Group 1 - Bin 3 phase	03 / 04	0.001°	0136	2	B136	2
Interharmonic Group 1 - Bin 4 magnitude	03 / 04	0.001% / mV / mA	0138	2	B138	2
Interharmonic Group 1 - Bin 4 phase	03 / 04	0.001°	013A	2	B13A	2
Interharmonic Group 1 - Bin 5 magnitude	03 / 04	0.001% / mV / mA	013C	2	B13C	2
Interharmonic Group 1 - Bin 5 phase	03 / 04	0.001°	013E	2	B13E	2
Interharmonic Group 1 - Bin 6 magnitude	03 / 04	0.001% / mV / mA	0140	2	B140	2
Interharmonic Group 1 - Bin 6 phase	03 / 04	0.001°	0142	2	B142	2
Interharmonic Group 1 - Bin 7 magnitude	03 / 04	0.001% / mV / mA	0144	2	B144	2
Interharmonic Group 1 - Bin 7 phase	03 / 04	0.001°	0146	2	B146	2
Interharmonic Group 1 - Bin 8 magnitude	03 / 04	0.001% / mV / mA	0148	2	B148	2
Interharmonic Group 1 - Bin 8 phase	03 / 04	0.001°	014A	2	B14A	2
Interharmonic Group 1 - Bin 9 magnitude	03 / 04	0.001% / mV / mA	014C	2	B14C	2
Interharmonic Group 1 - Bin 9 phase	03 / 04	0.001°	014E	2	B14E	2
2nd Harmonic Component - Magnitude	03 / 04	0.001% / mV / mA	0150	2	B150	2
2nd Harmonic Component - Phase	03 / 04	0.001°	0152	2	B152	2
Interharmonic Group 2 - Bin 1 magnitude	03 / 04	0.001% / mV / mA	0154	2	B154	2
Interharmonic Group 2 - Bin 1 phase	03 / 04	0.001°	0156	2	B156	2
Interharmonic Group 2 - Bin 2 magnitude	03 / 04	0.001% / mV / mA	0158	2	B158	2
Interharmonic Group 2 - Bin 2 phase	03 / 04	0.001°	015A	2	B15A	2
Interharmonic Group 2 - Bin 3 magnitude	03 / 04	0.001% / mV / mA	015C	2	B15C	2
Interharmonic Group 2 - Bin 3 phase	03 / 04	0.001°	015E	2	B15E	2
Interharmonic Group 2 - Bin 4 magnitude	03 / 04	0.001% / mV / mA	0160	2	B160	2
Interharmonic Group 2 - Bin 4 phase	03 / 04	0.001°	0162	2	B162	2
Interharmonic Group 2 - Bin 5 magnitude	03 / 04	0.001% / mV / mA	0164	2	B164	2
Interharmonic Group 2 - Bin 5 phase	03 / 04	0.001°	0166	2	B166	2
Interharmonic Group 2 - Bin 6 magnitude	03 / 04	0.001% / mV / mA	0168	2	B168	2
Interharmonic Group 2 - Bin 6 phase	03 / 04	0.001°	016A	2	B16A	2
Interharmonic Group 2 - Bin 7 magnitude	03 / 04	0.001% / mV / mA	016C	2	B16C	2
Interharmonic Group 2 - Bin 7 phase	03 / 04	0.001°	016E	2	B16E	2
Interharmonic Group 2 - Bin 8 magnitude	03 / 04	0.001% / mV / mA	0170	2	B170	2
Interharmonic Group 2 - Bin 8 phase	03 / 04	0.001°	0172	2	B172	2
Interharmonic Group 2 - Bin 9 magnitude	03 / 04	0.001% / mV / mA	0174	2	B174	2
Interharmonic Group 2 - Bin 9 phase	03 / 04	0.001°	0176	2	B176	2
3rd Harmonic Component - Magnitude	03 / 04	0.001% / mV / mA	0178	2	B178	2
3rd Harmonic Component - Phase	03 / 04	0.001°	017A	2	B17A	2
Interharmonic Group 3 - Bin 1 magnitude	03 / 04	0.001% / mV / mA	017C	2	B17C	2
Interharmonic Group 3 - Bin 1 phase	03 / 04	0.001°	017E	2	B17E	2

Parameter	F. code (Hex)	M.U.	INTEGER		IEEE	
			Register (Hex)	Words	Register (Hex)	Words
VOLTAGE & CURRENT HARMONICS & INTERHARMONICS MAGNITUDE&PHASE - fnom=50 Hz						
Interharmonic Group 3 - Bin 2 magnitude	03 / 04	0.001% / mV / mA	0180	2	B180	2
Interharmonic Group 3 - Bin 2 phase	03 / 04	0.001°	0182	2	B182	2
Interharmonic Group 3 - Bin 3 magnitude	03 / 04	0.001% / mV / mA	0184	2	B184	2
Interharmonic Group 3 - Bin 3 phase	03 / 04	0.001°	0186	2	B186	2
Interharmonic Group 3 - Bin 4 magnitude	03 / 04	0.001% / mV / mA	0188	2	B188	2
Interharmonic Group 3 - Bin 4 phase	03 / 04	0.001°	018A	2	B18A	2
Interharmonic Group 3 - Bin 5 magnitude	03 / 04	0.001% / mV / mA	018C	2	B18C	2
Interharmonic Group 3 - Bin 5 phase	03 / 04	0.001°	018E	2	B18E	2
Interharmonic Group 3 - Bin 6 magnitude	03 / 04	0.001% / mV / mA	0190	2	B190	2
Interharmonic Group 3 - Bin 6 phase	03 / 04	0.001°	0192	2	B192	2
Interharmonic Group 3 - Bin 7 magnitude	03 / 04	0.001% / mV / mA	0194	2	B194	2
Interharmonic Group 3 - Bin 7 phase	03 / 04	0.001°	0196	2	B196	2
Interharmonic Group 3 - Bin 8 magnitude	03 / 04	0.001% / mV / mA	0198	2	B198	2
Interharmonic Group 3 - Bin 8 phase	03 / 04	0.001°	019A	2	B19A	2
Interharmonic Group 3 - Bin 9 magnitude	03 / 04	0.001% / mV / mA	019C	2	B19C	2
Interharmonic Group 3 - Bin 9 phase	03 / 04	0.001°	019E	2	B19E	2
4th Harmonic Component - Magnitude	03 / 04	0.001% / mV / mA	01A0	2	B1A0	2
4th Harmonic Component - Phase	03 / 04	0.001°	01A2	2	B1A2	2
Interharmonic Group 4 - Bin 1 magnitude	03 / 04	0.001% / mV / mA	01A4	2	B1A4	2
Interharmonic Group 4 - Bin 1 phase	03 / 04	0.001°	01A6	2	B1A6	2
Interharmonic Group 4 - Bin 2 magnitude	03 / 04	0.001% / mV / mA	01A8	2	B1A8	2
Interharmonic Group 4 - Bin 2 phase	03 / 04	0.001°	01AA	2	B1AA	2
Interharmonic Group 4 - Bin 3 magnitude	03 / 04	0.001% / mV / mA	01AC	2	B1AC	2
Interharmonic Group 4 - Bin 3 phase	03 / 04	0.001°	01AE	2	B1AE	2
Interharmonic Group 4 - Bin 4 magnitude	03 / 04	0.001% / mV / mA	01B0	2	B1B0	2
Interharmonic Group 4 - Bin 4 phase	03 / 04	0.001°	01B2	2	B1B2	2
Interharmonic Group 4 - Bin 5 magnitude	03 / 04	0.001% / mV / mA	01B4	2	B1B4	2
Interharmonic Group 4 - Bin 5 phase	03 / 04	0.001°	01B6	2	B1B6	2
Interharmonic Group 4 - Bin 6 magnitude	03 / 04	0.001% / mV / mA	01B8	2	B1B8	2
Interharmonic Group 4 - Bin 6 phase	03 / 04	0.001°	01BA	2	B1BA	2
Interharmonic Group 4 - Bin 7 magnitude	03 / 04	0.001% / mV / mA	01BC	2	B1BC	2
Interharmonic Group 4 - Bin 7 phase	03 / 04	0.001°	01BE	2	B1BE	2
Interharmonic Group 4 - Bin 8 magnitude	03 / 04	0.001% / mV / mA	01C0	2	B1C0	2
Interharmonic Group 4 - Bin 8 phase	03 / 04	0.001°	01C2	2	B1C2	2
Interharmonic Group 4 - Bin 9 magnitude	03 / 04	0.001% / mV / mA	01C4	2	B1C4	2
Interharmonic Group 4 - Bin 9 phase	03 / 04	0.001°	01C6	2	B1C6	2
5th Harmonic Component - Magnitude	03 / 04	0.001% / mV / mA	01C8	2	B1C8	2
5th Harmonic Component - Phase	03 / 04	0.001°	01CA	2	B1CA	2
Interharmonic Group 5 - Bin 1 magnitude	03 / 04	0.001% / mV / mA	01CC	2	B1CC	2
Interharmonic Group 5 - Bin 1 phase	03 / 04	0.001°	01CE	2	B1CE	2
Interharmonic Group 5 - Bin 2 magnitude	03 / 04	0.001% / mV / mA	01D0	2	B1D0	2
Interharmonic Group 5 - Bin 2 phase	03 / 04	0.001°	01D2	2	B1D2	2
Interharmonic Group 5 - Bin 3 magnitude	03 / 04	0.001% / mV / mA	01D4	2	B1D4	2
Interharmonic Group 5 - Bin 3 phase	03 / 04	0.001°	01D6	2	B1D6	2
Interharmonic Group 5 - Bin 4 magnitude	03 / 04	0.001% / mV / mA	01D8	2	B1D8	2
Interharmonic Group 5 - Bin 4 phase	03 / 04	0.001°	01DA	2	B1DA	2
Interharmonic Group 5 - Bin 5 magnitude	03 / 04	0.001% / mV / mA	01DC	2	B1DC	2
Interharmonic Group 5 - Bin 5 phase	03 / 04	0.001°	01DE	2	B1DE	2
Interharmonic Group 5 - Bin 6 magnitude	03 / 04	0.001% / mV / mA	01E0	2	B1E0	2
Interharmonic Group 5 - Bin 6 phase	03 / 04	0.001°	01E2	2	B1E2	2

Parameter	F. code (Hex)	M.U.	INTEGER		IEEE	
			Register (Hex)	Words	Register (Hex)	Words
VOLTAGE & CURRENT HARMONICS & INTERHARMONICS MAGNITUDE&PHASE - fnom=50 Hz						
Interharmonic Group 5 - Bin 7 magnitude	03 / 04	0.001% / mV / mA	01E4	2	B1E4	2
Interharmonic Group 5 - Bin 7 phase	03 / 04	0.001°	01E6	2	B1E6	2
Interharmonic Group 5 - Bin 8 magnitude	03 / 04	0.001% / mV / mA	01E8	2	B1E8	2
Interharmonic Group 5 - Bin 8 phase	03 / 04	0.001°	01EA	2	B1EA	2
Interharmonic Group 5 - Bin 9 magnitude	03 / 04	0.001% / mV / mA	01EC	2	B1EC	2
Interharmonic Group 5 - Bin 9 phase	03 / 04	0.001°	01EE	2	B1EE	2
6th Harmonic Component - Magnitude	03 / 04	0.001% / mV / mA	01F0	2	B1F0	2
6th Harmonic Component - Phase	03 / 04	0.001°	01F2	2	B1F2	2
Interharmonic Group 6 - Bin 1 magnitude	03 / 04	0.001% / mV / mA	01F4	2	B1F4	2
Interharmonic Group 6 - Bin 1 phase	03 / 04	0.001°	01F6	2	B1F6	2
Interharmonic Group 6 - Bin 2 magnitude	03 / 04	0.001% / mV / mA	01F8	2	B1F8	2
Interharmonic Group 6 - Bin 2 phase	03 / 04	0.001°	01FA	2	B1FA	2
Interharmonic Group 6 - Bin 3 magnitude	03 / 04	0.001% / mV / mA	01FC	2	B1FC	2
Interharmonic Group 6 - Bin 3 phase	03 / 04	0.001°	01FE	2	B1FE	2
Interharmonic Group 6 - Bin 4 magnitude	03 / 04	0.001% / mV / mA	0200	2	B200	2
Interharmonic Group 6 - Bin 4 phase	03 / 04	0.001°	0202	2	B202	2
Interharmonic Group 6 - Bin 5 magnitude	03 / 04	0.001% / mV / mA	0204	2	B204	2
Interharmonic Group 6 - Bin 5 phase	03 / 04	0.001°	0206	2	B206	2
Interharmonic Group 6 - Bin 6 magnitude	03 / 04	0.001% / mV / mA	0208	2	B208	2
Interharmonic Group 6 - Bin 6 phase	03 / 04	0.001°	020A	2	B20A	2
Interharmonic Group 6 - Bin 7 magnitude	03 / 04	0.001% / mV / mA	020C	2	B20C	2
Interharmonic Group 6 - Bin 7 phase	03 / 04	0.001°	020E	2	B20E	2
Interharmonic Group 6 - Bin 8 magnitude	03 / 04	0.001% / mV / mA	0210	2	B210	2
Interharmonic Group 6 - Bin 8 phase	03 / 04	0.001°	0212	2	B212	2
Interharmonic Group 6 - Bin 9 magnitude	03 / 04	0.001% / mV / mA	0214	2	B214	2
Interharmonic Group 6 - Bin 9 phase	03 / 04	0.001°	0216	2	B216	2
7th Harmonic Component - Magnitude	03 / 04	0.001% / mV / mA	0218	2	B218	2
7th Harmonic Component - Phase	03 / 04	0.001°	021A	2	B21A	2
Interharmonic Group 7 - Bin 1 magnitude	03 / 04	0.001% / mV / mA	021C	2	B21C	2
Interharmonic Group 7 - Bin 1 phase	03 / 04	0.001°	021E	2	B21E	2
Interharmonic Group 7 - Bin 2 magnitude	03 / 04	0.001% / mV / mA	0220	2	B220	2
Interharmonic Group 7 - Bin 2 phase	03 / 04	0.001°	0222	2	B222	2
Interharmonic Group 7 - Bin 3 magnitude	03 / 04	0.001% / mV / mA	0224	2	B224	2
Interharmonic Group 7 - Bin 3 phase	03 / 04	0.001°	0226	2	B226	2
Interharmonic Group 7 - Bin 4 magnitude	03 / 04	0.001% / mV / mA	0228	2	B228	2
Interharmonic Group 7 - Bin 4 phase	03 / 04	0.001°	022A	2	B22A	2
Interharmonic Group 7 - Bin 5 magnitude	03 / 04	0.001% / mV / mA	022C	2	B22C	2
Interharmonic Group 7 - Bin 5 phase	03 / 04	0.001°	022E	2	B22E	2
Interharmonic Group 7 - Bin 6 magnitude	03 / 04	0.001% / mV / mA	0230	2	B230	2
Interharmonic Group 7 - Bin 6 phase	03 / 04	0.001°	0232	2	B232	2
Interharmonic Group 7 - Bin 7 magnitude	03 / 04	0.001% / mV / mA	0234	2	B234	2
Interharmonic Group 7 - Bin 7 phase	03 / 04	0.001°	0236	2	B236	2
Interharmonic Group 7 - Bin 8 magnitude	03 / 04	0.001% / mV / mA	0238	2	B238	2
Interharmonic Group 7 - Bin 8 phase	03 / 04	0.001°	023A	2	B23A	2
Interharmonic Group 7 - Bin 9 magnitude	03 / 04	0.001% / mV / mA	023C	2	B23C	2
Interharmonic Group 7 - Bin 9 phase	03 / 04	0.001°	023E	2	B23E	2
8th Harmonic Component - Magnitude	03 / 04	0.001% / mV / mA	0240	2	B240	2
8th Harmonic Component - Phase	03 / 04	0.001°	0242	2	B242	2
Interharmonic Group 8 - Bin 1 magnitude	03 / 04	0.001% / mV / mA	0244	2	B244	2
Interharmonic Group 8 - Bin 1 phase	03 / 04	0.001°	0246	2	B246	2

Parameter	F. code (Hex)	M.U.	INTEGER		IEEE	
			Register (Hex)	Words	Register (Hex)	Words
VOLTAGE & CURRENT HARMONICS & INTERHARMONICS MAGNITUDE&PHASE - fnom=50 Hz						
Interharmonic Group 8 - Bin 2 magnitude	03 / 04	0.001% / mV / mA	0248	2	B248	2
Interharmonic Group 8 - Bin 2 phase	03 / 04	0.001°	024A	2	B24A	2
Interharmonic Group 8 - Bin 3 magnitude	03 / 04	0.001% / mV / mA	024C	2	B24C	2
Interharmonic Group 8 - Bin 3 phase	03 / 04	0.001°	024E	2	B24E	2
Interharmonic Group 8 - Bin 4 magnitude	03 / 04	0.001% / mV / mA	0250	2	B250	2
Interharmonic Group 8 - Bin 4 phase	03 / 04	0.001°	0252	2	B252	2
Interharmonic Group 8 - Bin 5 magnitude	03 / 04	0.001% / mV / mA	0254	2	B254	2
Interharmonic Group 8 - Bin 5 phase	03 / 04	0.001°	0256	2	B256	2
Interharmonic Group 8 - Bin 6 magnitude	03 / 04	0.001% / mV / mA	0258	2	B258	2
Interharmonic Group 8 - Bin 6 phase	03 / 04	0.001°	025A	2	B25A	2
Interharmonic Group 8 - Bin 7 magnitude	03 / 04	0.001% / mV / mA	025C	2	B25C	2
Interharmonic Group 8 - Bin 7 phase	03 / 04	0.001°	025E	2	B25E	2
Interharmonic Group 8 - Bin 8 magnitude	03 / 04	0.001% / mV / mA	0260	2	B260	2
Interharmonic Group 8 - Bin 8 phase	03 / 04	0.001°	0262	2	B262	2
Interharmonic Group 8 - Bin 9 magnitude	03 / 04	0.001% / mV / mA	0264	2	B264	2
Interharmonic Group 8 - Bin 9 phase	03 / 04	0.001°	0266	2	B266	2
9th Harmonic Component - Magnitude	03 / 04	0.001% / mV / mA	0268	2	B268	2
9th Harmonic Component - Phase	03 / 04	0.001°	026A	2	B26A	2
Interharmonic Group 9 - Bin 1 magnitude	03 / 04	0.001% / mV / mA	026C	2	B26C	2
Interharmonic Group 9 - Bin 1 phase	03 / 04	0.001°	026E	2	B26E	2
Interharmonic Group 9 - Bin 2 magnitude	03 / 04	0.001% / mV / mA	0270	2	B270	2
Interharmonic Group 9 - Bin 2 phase	03 / 04	0.001°	0272	2	B272	2
Interharmonic Group 9 - Bin 3 magnitude	03 / 04	0.001% / mV / mA	0274	2	B274	2
Interharmonic Group 9 - Bin 3 phase	03 / 04	0.001°	0276	2	B276	2
Interharmonic Group 9 - Bin 4 magnitude	03 / 04	0.001% / mV / mA	0278	2	B278	2
Interharmonic Group 9 - Bin 4 phase	03 / 04	0.001°	027A	2	B27A	2
Interharmonic Group 9 - Bin 5 magnitude	03 / 04	0.001% / mV / mA	027C	2	B27C	2
Interharmonic Group 9 - Bin 5 phase	03 / 04	0.001°	027E	2	B27E	2
Interharmonic Group 9 - Bin 6 magnitude	03 / 04	0.001% / mV / mA	0280	2	B280	2
Interharmonic Group 9 - Bin 6 phase	03 / 04	0.001°	0282	2	B282	2
Interharmonic Group 9 - Bin 7 magnitude	03 / 04	0.001% / mV / mA	0284	2	B284	2
Interharmonic Group 9 - Bin 7 phase	03 / 04	0.001°	0286	2	B286	2
Interharmonic Group 9 - Bin 8 magnitude	03 / 04	0.001% / mV / mA	0288	2	B288	2
Interharmonic Group 9 - Bin 8 phase	03 / 04	0.001°	028A	2	B28A	2
Interharmonic Group 9 - Bin 9 magnitude	03 / 04	0.001% / mV / mA	028C	2	B28C	2
Interharmonic Group 9 - Bin 9 phase	03 / 04	0.001°	028E	2	B28E	2
10th Harmonic Component - Magnitude	03 / 04	0.001% / mV / mA	0290	2	B290	2
10th Harmonic Component - Phase	03 / 04	0.001°	0292	2	B292	2
Interharmonic Group 10 - Bin 1 magnitude	03 / 04	0.001% / mV / mA	0294	2	B294	2
Interharmonic Group 10 - Bin 1 phase	03 / 04	0.001°	0296	2	B296	2
Interharmonic Group 10 - Bin 2 magnitude	03 / 04	0.001% / mV / mA	0298	2	B298	2
Interharmonic Group 10 - Bin 2 phase	03 / 04	0.001°	029A	2	B29A	2
Interharmonic Group 10 - Bin 3 magnitude	03 / 04	0.001% / mV / mA	029C	2	B29C	2
Interharmonic Group 10 - Bin 3 phase	03 / 04	0.001°	029E	2	B29E	2
Interharmonic Group 10 - Bin 4 magnitude	03 / 04	0.001% / mV / mA	02A0	2	B2A0	2
Interharmonic Group 10 - Bin 4 phase	03 / 04	0.001°	02A2	2	B2A2	2
Interharmonic Group 10 - Bin 5 magnitude	03 / 04	0.001% / mV / mA	02A4	2	B2A4	2
Interharmonic Group 10 - Bin 5 phase	03 / 04	0.001°	02A6	2	B2A6	2
Interharmonic Group 10 - Bin 6 magnitude	03 / 04	0.001% / mV / mA	02A8	2	B2A8	2
Interharmonic Group 10 - Bin 6 phase	03 / 04	0.001°	02AA	2	B2AA	2

Parameter	F. code (Hex)	M.U.	INTEGER		IEEE	
			Register (Hex)	Words	Register (Hex)	Words
VOLTAGE & CURRENT HARMONICS & INTERHARMONICS MAGNITUDE&PHASE - fnom=50 Hz						
Interharmonic Group 10 - Bin 7 magnitude	03 / 04	0.001% / mV / mA	02AC	2	B2AC	2
Interharmonic Group 10 - Bin 7 phase	03 / 04	0.001°	02AE	2	B2AE	2
Interharmonic Group 10 - Bin 8 magnitude	03 / 04	0.001% / mV / mA	02B0	2	B2B0	2
Interharmonic Group 10 - Bin 8 phase	03 / 04	0.001°	02B2	2	B2B2	2
Interharmonic Group 10 - Bin 9 magnitude	03 / 04	0.001% / mV / mA	02B4	2	B2B4	2
Interharmonic Group 10 - Bin 9 phase	03 / 04	0.001°	02B6	2	B2B6	2
11th Harmonic Component - Magnitude	03 / 04	0.001% / mV / mA	02B8	2	B2B8	2
11th Harmonic Component - Phase	03 / 04	0.001°	02BA	2	B2BA	2
Interharmonic Group 11 - Bin 1 magnitude	03 / 04	0.001% / mV / mA	02BC	2	B2BC	2
Interharmonic Group 11 - Bin 1 phase	03 / 04	0.001°	02BE	2	B2BE	2
Interharmonic Group 11 - Bin 2 magnitude	03 / 04	0.001% / mV / mA	02C0	2	B2C0	2
Interharmonic Group 11 - Bin 2 phase	03 / 04	0.001°	02C2	2	B2C2	2
Interharmonic Group 11 - Bin 3 magnitude	03 / 04	0.001% / mV / mA	02C4	2	B2C4	2
Interharmonic Group 11 - Bin 3 phase	03 / 04	0.001°	02C6	2	B2C6	2
Interharmonic Group 11 - Bin 4 magnitude	03 / 04	0.001% / mV / mA	02C8	2	B2C8	2
Interharmonic Group 11 - Bin 4 phase	03 / 04	0.001°	02CA	2	B2CA	2
Interharmonic Group 11 - Bin 5 magnitude	03 / 04	0.001% / mV / mA	02CC	2	B2CC	2
Interharmonic Group 11 - Bin 5 phase	03 / 04	0.001°	02CE	2	B2CE	2
Interharmonic Group 11 - Bin 6 magnitude	03 / 04	0.001% / mV / mA	02D0	2	B2D0	2
Interharmonic Group 11 - Bin 6 phase	03 / 04	0.001°	02D2	2	B2D2	2
Interharmonic Group 11 - Bin 7 magnitude	03 / 04	0.001% / mV / mA	02D4	2	B2D4	2
Interharmonic Group 11 - Bin 7 phase	03 / 04	0.001°	02D6	2	B2D6	2
Interharmonic Group 11 - Bin 8 magnitude	03 / 04	0.001% / mV / mA	02D8	2	B2D8	2
Interharmonic Group 11 - Bin 8 phase	03 / 04	0.001°	02DA	2	B2DA	2
Interharmonic Group 11 - Bin 9 magnitude	03 / 04	0.001% / mV / mA	02DC	2	B2DC	2
Interharmonic Group 11 - Bin 9 phase	03 / 04	0.001°	02DE	2	B2DE	2
12th Harmonic Component - Magnitude	03 / 04	0.001% / mV / mA	02E0	2	B2E0	2
12th Harmonic Component - Phase	03 / 04	0.001°	02E2	2	B2E2	2
Interharmonic Group 12 - Bin 1 magnitude	03 / 04	0.001% / mV / mA	02E4	2	B2E4	2
Interharmonic Group 12 - Bin 1 phase	03 / 04	0.001°	02E6	2	B2E6	2
Interharmonic Group 12 - Bin 2 magnitude	03 / 04	0.001% / mV / mA	02E8	2	B2E8	2
Interharmonic Group 12 - Bin 2 phase	03 / 04	0.001°	02EA	2	B2EA	2
Interharmonic Group 12 - Bin 3 magnitude	03 / 04	0.001% / mV / mA	02EC	2	B2EC	2
Interharmonic Group 12 - Bin 3 phase	03 / 04	0.001°	02EE	2	B2EE	2
Interharmonic Group 12 - Bin 4 magnitude	03 / 04	0.001% / mV / mA	02F0	2	B2F0	2
Interharmonic Group 12 - Bin 4 phase	03 / 04	0.001°	02F2	2	B2F2	2
Interharmonic Group 12 - Bin 5 magnitude	03 / 04	0.001% / mV / mA	02F4	2	B2F4	2
Interharmonic Group 12 - Bin 5 phase	03 / 04	0.001°	02F6	2	B2F6	2
Interharmonic Group 12 - Bin 6 magnitude	03 / 04	0.001% / mV / mA	02F8	2	B2F8	2
Interharmonic Group 12 - Bin 6 phase	03 / 04	0.001°	02FA	2	B2FA	2
Interharmonic Group 12 - Bin 7 magnitude	03 / 04	0.001% / mV / mA	02FC	2	B2FC	2
Interharmonic Group 12 - Bin 7 phase	03 / 04	0.001°	02FE	2	B2FE	2
Interharmonic Group 12 - Bin 8 magnitude	03 / 04	0.001% / mV / mA	0300	2	B300	2
Interharmonic Group 12 - Bin 8 phase	03 / 04	0.001°	0302	2	B302	2
Interharmonic Group 12 - Bin 9 magnitude	03 / 04	0.001% / mV / mA	0304	2	B304	2
Interharmonic Group 12 - Bin 9 phase	03 / 04	0.001°	0306	2	B306	2
13th Harmonic Component - Magnitude	03 / 04	0.001% / mV / mA	0308	2	B308	2
13th Harmonic Component - Phase	03 / 04	0.001°	030A	2	B30A	2
Interharmonic Group 13 - Bin 1 magnitude	03 / 04	0.001% / mV / mA	030C	2	B30C	2
Interharmonic Group 13 - Bin 1 phase	03 / 04	0.001°	030E	2	B30E	2

Parameter	F. code (Hex)	M.U.	INTEGER		IEEE	
			Register (Hex)	Words	Register (Hex)	Words
VOLTAGE & CURRENT HARMONICS & INTERHARMONICS MAGNITUDE&PHASE - fnom=50 Hz						
Interharmonic Group 13 - Bin 2 magnitude	03 / 04	0.001% / mV / mA	0310	2	B310	2
Interharmonic Group 13 - Bin 2 phase	03 / 04	0.001°	0312	2	B312	2
Interharmonic Group 13 - Bin 3 magnitude	03 / 04	0.001% / mV / mA	0314	2	B314	2
Interharmonic Group 13 - Bin 3 phase	03 / 04	0.001°	0316	2	B316	2
Interharmonic Group 13 - Bin 4 magnitude	03 / 04	0.001% / mV / mA	0318	2	B318	2
Interharmonic Group 13 - Bin 4 phase	03 / 04	0.001°	031A	2	B31A	2
Interharmonic Group 13 - Bin 5 magnitude	03 / 04	0.001% / mV / mA	031C	2	B31C	2
Interharmonic Group 13 - Bin 5 phase	03 / 04	0.001°	031E	2	B31E	2
Interharmonic Group 13 - Bin 6 magnitude	03 / 04	0.001% / mV / mA	0320	2	B320	2
Interharmonic Group 13 - Bin 6 phase	03 / 04	0.001°	0322	2	B322	2
Interharmonic Group 13 - Bin 7 magnitude	03 / 04	0.001% / mV / mA	0324	2	B324	2
Interharmonic Group 13 - Bin 7 phase	03 / 04	0.001°	0326	2	B326	2
Interharmonic Group 13 - Bin 8 magnitude	03 / 04	0.001% / mV / mA	0328	2	B328	2
Interharmonic Group 13 - Bin 8 phase	03 / 04	0.001°	032A	2	B32A	2
Interharmonic Group 13 - Bin 9 magnitude	03 / 04	0.001% / mV / mA	032C	2	B32C	2
Interharmonic Group 13 - Bin 9 phase	03 / 04	0.001°	032E	2	B32E	2
14th Harmonic Component - Magnitude	03 / 04	0.001% / mV / mA	0330	2	B330	2
14th Harmonic Component - Phase	03 / 04	0.001°	0332	2	B332	2
Interharmonic Group 14 - Bin 1 magnitude	03 / 04	0.001% / mV / mA	0334	2	B334	2
Interharmonic Group 14 - Bin 1 phase	03 / 04	0.001°	0336	2	B336	2
Interharmonic Group 14 - Bin 2 magnitude	03 / 04	0.001% / mV / mA	0338	2	B338	2
Interharmonic Group 14 - Bin 2 phase	03 / 04	0.001°	033A	2	B33A	2
Interharmonic Group 14 - Bin 3 magnitude	03 / 04	0.001% / mV / mA	033C	2	B33C	2
Interharmonic Group 14 - Bin 3 phase	03 / 04	0.001°	033E	2	B33E	2
Interharmonic Group 14 - Bin 4 magnitude	03 / 04	0.001% / mV / mA	0340	2	B340	2
Interharmonic Group 14 - Bin 4 phase	03 / 04	0.001°	0342	2	B342	2
Interharmonic Group 14 - Bin 5 magnitude	03 / 04	0.001% / mV / mA	0344	2	B344	2
Interharmonic Group 14 - Bin 5 phase	03 / 04	0.001°	0346	2	B346	2
Interharmonic Group 14 - Bin 6 magnitude	03 / 04	0.001% / mV / mA	0348	2	B348	2
Interharmonic Group 14 - Bin 6 phase	03 / 04	0.001°	034A	2	B34A	2
Interharmonic Group 14 - Bin 7 magnitude	03 / 04	0.001% / mV / mA	034C	2	B34C	2
Interharmonic Group 14 - Bin 7 phase	03 / 04	0.001°	034E	2	B34E	2
Interharmonic Group 14 - Bin 8 magnitude	03 / 04	0.001% / mV / mA	0350	2	B350	2
Interharmonic Group 14 - Bin 8 phase	03 / 04	0.001°	0352	2	B352	2
Interharmonic Group 14 - Bin 9 magnitude	03 / 04	0.001% / mV / mA	0354	2	B354	2
Interharmonic Group 14 - Bin 9 phase	03 / 04	0.001°	0356	2	B356	2
15th Harmonic Component - Magnitude	03 / 04	0.001% / mV / mA	0358	2	B358	2
15th Harmonic Component - Phase	03 / 04	0.001°	035A	2	B35A	2
Interharmonic Group 15 - Bin 1 magnitude	03 / 04	0.001% / mV / mA	035C	2	B35C	2
Interharmonic Group 15 - Bin 1 phase	03 / 04	0.001°	035E	2	B35E	2
Interharmonic Group 15 - Bin 2 magnitude	03 / 04	0.001% / mV / mA	0360	2	B360	2
Interharmonic Group 15 - Bin 2 phase	03 / 04	0.001°	0362	2	B362	2
Interharmonic Group 15 - Bin 3 magnitude	03 / 04	0.001% / mV / mA	0364	2	B364	2
Interharmonic Group 15 - Bin 3 phase	03 / 04	0.001°	0366	2	B366	2
Interharmonic Group 15 - Bin 4 magnitude	03 / 04	0.001% / mV / mA	0368	2	B368	2
Interharmonic Group 15 - Bin 4 phase	03 / 04	0.001°	036A	2	B36A	2
Interharmonic Group 15 - Bin 5 magnitude	03 / 04	0.001% / mV / mA	036C	2	B36C	2
Interharmonic Group 15 - Bin 5 phase	03 / 04	0.001°	036E	2	B36E	2
Interharmonic Group 15 - Bin 6 magnitude	03 / 04	0.001% / mV / mA	0370	2	B370	2
Interharmonic Group 15 - Bin 6 phase	03 / 04	0.001°	0372	2	B372	2

Parameter	F. code (Hex)	M.U.	INTEGER		IEEE	
			Register (Hex)	Words	Register (Hex)	Words
VOLTAGE & CURRENT HARMONICS & INTERHARMONICS MAGNITUDE&PHASE - fnom=50 Hz						
Interharmonic Group 15 - Bin 7 magnitude	03 / 04	0.001% / mV / mA	0374	2	B374	2
Interharmonic Group 15 - Bin 7 phase	03 / 04	0.001°	0376	2	B376	2
Interharmonic Group 15 - Bin 8 magnitude	03 / 04	0.001% / mV / mA	0378	2	B378	2
Interharmonic Group 15 - Bin 8 phase	03 / 04	0.001°	037A	2	B37A	2
Interharmonic Group 15 - Bin 9 magnitude	03 / 04	0.001% / mV / mA	037C	2	B37C	2
Interharmonic Group 15 - Bin 9 phase	03 / 04	0.001°	037E	2	B37E	2
16th Harmonic Component - Magnitude	03 / 04	0.001% / mV / mA	0380	2	B380	2
16th Harmonic Component - Phase	03 / 04	0.001°	0382	2	B382	2
Interharmonic Group 16 - Bin 1 magnitude	03 / 04	0.001% / mV / mA	0384	2	B384	2
Interharmonic Group 16 - Bin 1 phase	03 / 04	0.001°	0386	2	B386	2
Interharmonic Group 16 - Bin 2 magnitude	03 / 04	0.001% / mV / mA	0388	2	B388	2
Interharmonic Group 16 - Bin 2 phase	03 / 04	0.001°	038A	2	B38A	2
Interharmonic Group 16 - Bin 3 magnitude	03 / 04	0.001% / mV / mA	038C	2	B38C	2
Interharmonic Group 16 - Bin 3 phase	03 / 04	0.001°	038E	2	B38E	2
Interharmonic Group 16 - Bin 4 magnitude	03 / 04	0.001% / mV / mA	0390	2	B390	2
Interharmonic Group 16 - Bin 4 phase	03 / 04	0.001°	0392	2	B392	2
Interharmonic Group 16 - Bin 5 magnitude	03 / 04	0.001% / mV / mA	0394	2	B394	2
Interharmonic Group 16 - Bin 5 phase	03 / 04	0.001°	0396	2	B396	2
Interharmonic Group 16 - Bin 6 magnitude	03 / 04	0.001% / mV / mA	0398	2	B398	2
Interharmonic Group 16 - Bin 6 phase	03 / 04	0.001°	039A	2	B39A	2
Interharmonic Group 16 - Bin 7 magnitude	03 / 04	0.001% / mV / mA	039C	2	B39C	2
Interharmonic Group 16 - Bin 7 phase	03 / 04	0.001°	039E	2	B39E	2
Interharmonic Group 16 - Bin 8 magnitude	03 / 04	0.001% / mV / mA	03A0	2	B3A0	2
Interharmonic Group 16 - Bin 8 phase	03 / 04	0.001°	03A2	2	B3A2	2
Interharmonic Group 16 - Bin 9 magnitude	03 / 04	0.001% / mV / mA	03A4	2	B3A4	2
Interharmonic Group 16 - Bin 9 phase	03 / 04	0.001°	03A6	2	B3A6	2
17th Harmonic Component - Magnitude	03 / 04	0.001% / mV / mA	03A8	2	B3A8	2
17th Harmonic Component - Phase	03 / 04	0.001°	03AA	2	B3AA	2
Interharmonic Group 17 - Bin 1 magnitude	03 / 04	0.001% / mV / mA	03AC	2	B3AC	2
Interharmonic Group 17 - Bin 1 phase	03 / 04	0.001°	03AE	2	B3AE	2
Interharmonic Group 17 - Bin 2 magnitude	03 / 04	0.001% / mV / mA	03B0	2	B3B0	2
Interharmonic Group 17 - Bin 2 phase	03 / 04	0.001°	03B2	2	B3B2	2
Interharmonic Group 17 - Bin 3 magnitude	03 / 04	0.001% / mV / mA	03B4	2	B3B4	2
Interharmonic Group 17 - Bin 3 phase	03 / 04	0.001°	03B6	2	B3B6	2
Interharmonic Group 17 - Bin 4 magnitude	03 / 04	0.001% / mV / mA	03B8	2	B3B8	2
Interharmonic Group 17 - Bin 4 phase	03 / 04	0.001°	03BA	2	B3BA	2
Interharmonic Group 17 - Bin 5 magnitude	03 / 04	0.001% / mV / mA	03BC	2	B3BC	2
Interharmonic Group 17 - Bin 5 phase	03 / 04	0.001°	03BE	2	B3BE	2
Interharmonic Group 17 - Bin 6 magnitude	03 / 04	0.001% / mV / mA	03C0	2	B3C0	2
Interharmonic Group 17 - Bin 6 phase	03 / 04	0.001°	03C2	2	B3C2	2
Interharmonic Group 17 - Bin 7 magnitude	03 / 04	0.001% / mV / mA	03C4	2	B3C4	2
Interharmonic Group 17 - Bin 7 phase	03 / 04	0.001°	03C6	2	B3C6	2
Interharmonic Group 17 - Bin 8 magnitude	03 / 04	0.001% / mV / mA	03C8	2	B3C8	2
Interharmonic Group 17 - Bin 8 phase	03 / 04	0.001°	03CA	2	B3CA	2
Interharmonic Group 17 - Bin 9 magnitude	03 / 04	0.001% / mV / mA	03CC	2	B3CC	2
Interharmonic Group 17 - Bin 9 phase	03 / 04	0.001°	03CE	2	B3CE	2
18th Harmonic Component - Magnitude	03 / 04	0.001% / mV / mA	03D0	2	B3D0	2
18th Harmonic Component - Phase	03 / 04	0.001°	03D2	2	B3D2	2
Interharmonic Group 18 - Bin 1 magnitude	03 / 04	0.001% / mV / mA	03D4	2	B3D4	2
Interharmonic Group 18 - Bin 1 phase	03 / 04	0.001°	03D6	2	B3D6	2

Parameter	F. code (Hex)	M.U.	INTEGER		IEEE	
			Register (Hex)	Words	Register (Hex)	Words
VOLTAGE & CURRENT HARMONICS & INTERHARMONICS MAGNITUDE&PHASE - fnom=50 Hz						
Interharmonic Group 18 - Bin 2 magnitude	03 / 04	0.001% / mV / mA	03D8	2	B3D8	2
Interharmonic Group 18 - Bin 2 phase	03 / 04	0.001°	03DA	2	B3DA	2
Interharmonic Group 18 - Bin 3 magnitude	03 / 04	0.001% / mV / mA	03DC	2	B3DC	2
Interharmonic Group 18 - Bin 3 phase	03 / 04	0.001°	03DE	2	B3DE	2
Interharmonic Group 18 - Bin 4 magnitude	03 / 04	0.001% / mV / mA	03E0	2	B3E0	2
Interharmonic Group 18 - Bin 4 phase	03 / 04	0.001°	03E2	2	B3E2	2
Interharmonic Group 18 - Bin 5 magnitude	03 / 04	0.001% / mV / mA	03E4	2	B3E4	2
Interharmonic Group 18 - Bin 5 phase	03 / 04	0.001°	03E6	2	B3E6	2
Interharmonic Group 18 - Bin 6 magnitude	03 / 04	0.001% / mV / mA	03E8	2	B3E8	2
Interharmonic Group 18 - Bin 6 phase	03 / 04	0.001°	03EA	2	B3EA	2
Interharmonic Group 18 - Bin 7 magnitude	03 / 04	0.001% / mV / mA	03EC	2	B3EC	2
Interharmonic Group 18 - Bin 7 phase	03 / 04	0.001°	03EE	2	B3EE	2
Interharmonic Group 18 - Bin 8 magnitude	03 / 04	0.001% / mV / mA	03F0	2	B3F0	2
Interharmonic Group 18 - Bin 8 phase	03 / 04	0.001°	03F2	2	B3F2	2
Interharmonic Group 18 - Bin 9 magnitude	03 / 04	0.001% / mV / mA	03F4	2	B3F4	2
Interharmonic Group 18 - Bin 9 phase	03 / 04	0.001°	03F6	2	B3F6	2
19th Harmonic Component - Magnitude	03 / 04	0.001% / mV / mA	03F8	2	B3F8	2
19th Harmonic Component - Phase	03 / 04	0.001°	03FA	2	B3FA	2
Interharmonic Group 19 - Bin 1 magnitude	03 / 04	0.001% / mV / mA	03FC	2	B3FC	2
Interharmonic Group 19 - Bin 1 phase	03 / 04	0.001°	03FE	2	B3FE	2
Interharmonic Group 19 - Bin 2 magnitude	03 / 04	0.001% / mV / mA	0400	2	B400	2
Interharmonic Group 19 - Bin 2 phase	03 / 04	0.001°	0402	2	B402	2
Interharmonic Group 19 - Bin 3 magnitude	03 / 04	0.001% / mV / mA	0404	2	B404	2
Interharmonic Group 19 - Bin 3 phase	03 / 04	0.001°	0406	2	B406	2
Interharmonic Group 19 - Bin 4 magnitude	03 / 04	0.001% / mV / mA	0408	2	B408	2
Interharmonic Group 19 - Bin 4 phase	03 / 04	0.001°	040A	2	B40A	2
Interharmonic Group 19 - Bin 5 magnitude	03 / 04	0.001% / mV / mA	040C	2	B40C	2
Interharmonic Group 19 - Bin 5 phase	03 / 04	0.001°	040E	2	B40E	2
Interharmonic Group 19 - Bin 6 magnitude	03 / 04	0.001% / mV / mA	0410	2	B410	2
Interharmonic Group 19 - Bin 6 phase	03 / 04	0.001°	0412	2	B412	2
Interharmonic Group 19 - Bin 7 magnitude	03 / 04	0.001% / mV / mA	0414	2	B414	2
Interharmonic Group 19 - Bin 7 phase	03 / 04	0.001°	0416	2	B416	2
Interharmonic Group 19 - Bin 8 magnitude	03 / 04	0.001% / mV / mA	0418	2	B418	2
Interharmonic Group 19 - Bin 8 phase	03 / 04	0.001°	041A	2	B41A	2
Interharmonic Group 19 - Bin 9 magnitude	03 / 04	0.001% / mV / mA	041C	2	B41C	2
Interharmonic Group 19 - Bin 9 phase	03 / 04	0.001°	041E	2	B41E	2
20th Harmonic Component - Magnitude	03 / 04	0.001% / mV / mA	0420	2	B420	2
20th Harmonic Component - Phase	03 / 04	0.001°	0422	2	B422	2
Interharmonic Group 20 - Bin 1 magnitude	03 / 04	0.001% / mV / mA	0424	2	B424	2
Interharmonic Group 20 - Bin 1 phase	03 / 04	0.001°	0426	2	B426	2
Interharmonic Group 20 - Bin 2 magnitude	03 / 04	0.001% / mV / mA	0428	2	B428	2
Interharmonic Group 20 - Bin 2 phase	03 / 04	0.001°	042A	2	B42A	2
Interharmonic Group 20 - Bin 3 magnitude	03 / 04	0.001% / mV / mA	042C	2	B42C	2
Interharmonic Group 20 - Bin 3 phase	03 / 04	0.001°	042E	2	B42E	2
Interharmonic Group 20 - Bin 4 magnitude	03 / 04	0.001% / mV / mA	0430	2	B430	2
Interharmonic Group 20 - Bin 4 phase	03 / 04	0.001°	0432	2	B432	2
Interharmonic Group 20 - Bin 5 magnitude	03 / 04	0.001% / mV / mA	0434	2	B434	2
Interharmonic Group 20 - Bin 5 phase	03 / 04	0.001°	0436	2	B436	2
Interharmonic Group 20 - Bin 6 magnitude	03 / 04	0.001% / mV / mA	0438	2	B438	2
Interharmonic Group 20 - Bin 6 phase	03 / 04	0.001°	043A	2	B43A	2

Parameter	F. code (Hex)	M.U.	INTEGER		IEEE	
			Register (Hex)	Words	Register (Hex)	Words
VOLTAGE & CURRENT HARMONICS & INTERHARMONICS MAGNITUDE&PHASE - fnom=50 Hz						
Interharmonic Group 20 - Bin 7 magnitude	03 / 04	0.001% / mV / mA	043C	2	B43C	2
Interharmonic Group 20 - Bin 7 phase	03 / 04	0.001°	043E	2	B43E	2
Interharmonic Group 20 - Bin 8 magnitude	03 / 04	0.001% / mV / mA	0440	2	B440	2
Interharmonic Group 20 - Bin 8 phase	03 / 04	0.001°	0442	2	B442	2
Interharmonic Group 20 - Bin 9 magnitude	03 / 04	0.001% / mV / mA	0444	2	B444	2
Interharmonic Group 20 - Bin 9 phase	03 / 04	0.001°	0446	2	B446	2
21st Harmonic Component - Magnitude	03 / 04	0.001% / mV / mA	0448	2	B448	2
21st Harmonic Component - Phase	03 / 04	0.001°	044A	2	B44A	2
Interharmonic Group 21 - Bin 1 magnitude	03 / 04	0.001% / mV / mA	044C	2	B44C	2
Interharmonic Group 21 - Bin 1 phase	03 / 04	0.001°	044E	2	B44E	2
Interharmonic Group 21 - Bin 2 magnitude	03 / 04	0.001% / mV / mA	0450	2	B450	2
Interharmonic Group 21 - Bin 2 phase	03 / 04	0.001°	0452	2	B452	2
Interharmonic Group 21 - Bin 3 magnitude	03 / 04	0.001% / mV / mA	0454	2	B454	2
Interharmonic Group 21 - Bin 3 phase	03 / 04	0.001°	0456	2	B456	2
Interharmonic Group 21 - Bin 4 magnitude	03 / 04	0.001% / mV / mA	0458	2	B458	2
Interharmonic Group 21 - Bin 4 phase	03 / 04	0.001°	045A	2	B45A	2
Interharmonic Group 21 - Bin 5 magnitude	03 / 04	0.001% / mV / mA	045C	2	B45C	2
Interharmonic Group 21 - Bin 5 phase	03 / 04	0.001°	045E	2	B45E	2
Interharmonic Group 21 - Bin 6 magnitude	03 / 04	0.001% / mV / mA	0460	2	B460	2
Interharmonic Group 21 - Bin 6 phase	03 / 04	0.001°	0462	2	B462	2
Interharmonic Group 21 - Bin 7 magnitude	03 / 04	0.001% / mV / mA	0464	2	B464	2
Interharmonic Group 21 - Bin 7 phase	03 / 04	0.001°	0466	2	B466	2
Interharmonic Group 21 - Bin 8 magnitude	03 / 04	0.001% / mV / mA	0468	2	B468	2
Interharmonic Group 21 - Bin 8 phase	03 / 04	0.001°	046A	2	B46A	2
Interharmonic Group 21 - Bin 9 magnitude	03 / 04	0.001% / mV / mA	046C	2	B46C	2
Interharmonic Group 21 - Bin 9 phase	03 / 04	0.001°	046E	2	B46E	2
22nd Harmonic Component - Magnitude	03 / 04	0.001% / mV / mA	0470	2	B470	2
22nd Harmonic Component - Phase	03 / 04	0.001°	0472	2	B472	2
Interharmonic Group 22 - Bin 1 magnitude	03 / 04	0.001% / mV / mA	0474	2	B474	2
Interharmonic Group 22 - Bin 1 phase	03 / 04	0.001°	0476	2	B476	2
Interharmonic Group 22 - Bin 2 magnitude	03 / 04	0.001% / mV / mA	0478	2	B478	2
Interharmonic Group 22 - Bin 2 phase	03 / 04	0.001°	047A	2	B47A	2
Interharmonic Group 22 - Bin 3 magnitude	03 / 04	0.001% / mV / mA	047C	2	B47C	2
Interharmonic Group 22 - Bin 3 phase	03 / 04	0.001°	047E	2	B47E	2
Interharmonic Group 22 - Bin 4 magnitude	03 / 04	0.001% / mV / mA	0480	2	B480	2
Interharmonic Group 22 - Bin 4 phase	03 / 04	0.001°	0482	2	B482	2
Interharmonic Group 22 - Bin 5 magnitude	03 / 04	0.001% / mV / mA	0484	2	B484	2
Interharmonic Group 22 - Bin 5 phase	03 / 04	0.001°	0486	2	B486	2
Interharmonic Group 22 - Bin 6 magnitude	03 / 04	0.001% / mV / mA	0488	2	B488	2
Interharmonic Group 22 - Bin 6 phase	03 / 04	0.001°	048A	2	B48A	2
Interharmonic Group 22 - Bin 7 magnitude	03 / 04	0.001% / mV / mA	048C	2	B48C	2
Interharmonic Group 22 - Bin 7 phase	03 / 04	0.001°	048E	2	B48E	2
Interharmonic Group 22 - Bin 8 magnitude	03 / 04	0.001% / mV / mA	0490	2	B490	2
Interharmonic Group 22 - Bin 8 phase	03 / 04	0.001°	0492	2	B492	2
Interharmonic Group 22 - Bin 9 magnitude	03 / 04	0.001% / mV / mA	0494	2	B494	2
Interharmonic Group 22 - Bin 9 phase	03 / 04	0.001°	0496	2	B496	2
23rd Harmonic Component - Magnitude	03 / 04	0.001% / mV / mA	0498	2	B498	2
23rd Harmonic Component - Phase	03 / 04	0.001°	049A	2	B49A	2
Interharmonic Group 23 - Bin 1 magnitude	03 / 04	0.001% / mV / mA	049C	2	B49C	2
Interharmonic Group 23 - Bin 1 phase	03 / 04	0.001°	049E	2	B49E	2

Parameter	F. code (Hex)	M.U.	INTEGER		IEEE	
			Register (Hex)	Words	Register (Hex)	Words
VOLTAGE & CURRENT HARMONICS & INTERHARMONICS MAGNITUDE&PHASE - fnom=50 Hz						
Interharmonic Group 23 - Bin 2 magnitude	03 / 04	0.001% / mV / mA	04A0	2	B4A0	2
Interharmonic Group 23 - Bin 2 phase	03 / 04	0.001°	04A2	2	B4A2	2
Interharmonic Group 23 - Bin 3 magnitude	03 / 04	0.001% / mV / mA	04A4	2	B4A4	2
Interharmonic Group 23 - Bin 3 phase	03 / 04	0.001°	04A6	2	B4A6	2
Interharmonic Group 23 - Bin 4 magnitude	03 / 04	0.001% / mV / mA	04A8	2	B4A8	2
Interharmonic Group 23 - Bin 4 phase	03 / 04	0.001°	04AA	2	B4AA	2
Interharmonic Group 23 - Bin 5 magnitude	03 / 04	0.001% / mV / mA	04AC	2	B4AC	2
Interharmonic Group 23 - Bin 5 phase	03 / 04	0.001°	04AE	2	B4AE	2
Interharmonic Group 23 - Bin 6 magnitude	03 / 04	0.001% / mV / mA	04B0	2	B4B0	2
Interharmonic Group 23 - Bin 6 phase	03 / 04	0.001°	04B2	2	B4B2	2
Interharmonic Group 23 - Bin 7 magnitude	03 / 04	0.001% / mV / mA	04B4	2	B4B4	2
Interharmonic Group 23 - Bin 7 phase	03 / 04	0.001°	04B6	2	B4B6	2
Interharmonic Group 23 - Bin 8 magnitude	03 / 04	0.001% / mV / mA	04B8	2	B4B8	2
Interharmonic Group 23 - Bin 8 phase	03 / 04	0.001°	04BA	2	B4BA	2
Interharmonic Group 23 - Bin 9 magnitude	03 / 04	0.001% / mV / mA	04BC	2	B4BC	2
Interharmonic Group 23 - Bin 9 phase	03 / 04	0.001°	04BE	2	B4BE	2
24th Harmonic Component - Magnitude	03 / 04	0.001% / mV / mA	04C0	2	B4C0	2
24th Harmonic Component - Phase	03 / 04	0.001°	04C2	2	B4C2	2
Interharmonic Group 24 - Bin 1 magnitude	03 / 04	0.001% / mV / mA	04C4	2	B4C4	2
Interharmonic Group 24 - Bin 1 phase	03 / 04	0.001°	04C6	2	B4C6	2
Interharmonic Group 24 - Bin 2 magnitude	03 / 04	0.001% / mV / mA	04C8	2	B4C8	2
Interharmonic Group 24 - Bin 2 phase	03 / 04	0.001°	04CA	2	B4CA	2
Interharmonic Group 24 - Bin 3 magnitude	03 / 04	0.001% / mV / mA	04CC	2	B4CC	2
Interharmonic Group 24 - Bin 3 phase	03 / 04	0.001°	04CE	2	B4CE	2
Interharmonic Group 24 - Bin 4 magnitude	03 / 04	0.001% / mV / mA	04D0	2	B4D0	2
Interharmonic Group 24 - Bin 4 phase	03 / 04	0.001°	04D2	2	B4D2	2
Interharmonic Group 24 - Bin 5 magnitude	03 / 04	0.001% / mV / mA	04D4	2	B4D4	2
Interharmonic Group 24 - Bin 5 phase	03 / 04	0.001°	04D6	2	B4D6	2
Interharmonic Group 24 - Bin 6 magnitude	03 / 04	0.001% / mV / mA	04D8	2	B4D8	2
Interharmonic Group 24 - Bin 6 phase	03 / 04	0.001°	04DA	2	B4DA	2
Interharmonic Group 24 - Bin 7 magnitude	03 / 04	0.001% / mV / mA	04DC	2	B4DC	2
Interharmonic Group 24 - Bin 7 phase	03 / 04	0.001°	04DE	2	B4DE	2
Interharmonic Group 24 - Bin 8 magnitude	03 / 04	0.001% / mV / mA	04E0	2	B4E0	2
Interharmonic Group 24 - Bin 8 phase	03 / 04	0.001°	04E2	2	B4E2	2
Interharmonic Group 24 - Bin 9 magnitude	03 / 04	0.001% / mV / mA	04E4	2	B4E4	2
Interharmonic Group 24 - Bin 9 phase	03 / 04	0.001°	04E6	2	B4E6	2
25th Harmonic Component - Magnitude	03 / 04	0.001% / mV / mA	04E8	2	B4E8	2
25th Harmonic Component - Phase	03 / 04	0.001°	04EA	2	B4EA	2
Interharmonic Group 25 - Bin 1 magnitude	03 / 04	0.001% / mV / mA	04EC	2	B4EC	2
Interharmonic Group 25 - Bin 1 phase	03 / 04	0.001°	04EE	2	B4EE	2
Interharmonic Group 25 - Bin 2 magnitude	03 / 04	0.001% / mV / mA	04F0	2	B4F0	2
Interharmonic Group 25 - Bin 2 phase	03 / 04	0.001°	04F2	2	B4F2	2
Interharmonic Group 25 - Bin 3 magnitude	03 / 04	0.001% / mV / mA	04F4	2	B4F4	2
Interharmonic Group 25 - Bin 3 phase	03 / 04	0.001°	04F6	2	B4F6	2
Interharmonic Group 25 - Bin 4 magnitude	03 / 04	0.001% / mV / mA	04F8	2	B4F8	2
Interharmonic Group 25 - Bin 4 phase	03 / 04	0.001°	04FA	2	B4FA	2
Interharmonic Group 25 - Bin 5 magnitude	03 / 04	0.001% / mV / mA	04FC	2	B4FC	2
Interharmonic Group 25 - Bin 5 phase	03 / 04	0.001°	04FE	2	B4FE	2
Interharmonic Group 25 - Bin 6 magnitude	03 / 04	0.001% / mV / mA	0500	2	B500	2
Interharmonic Group 25 - Bin 6 phase	03 / 04	0.001°	0502	2	B502	2

Parameter	F. code (Hex)	M.U.	INTEGER		IEEE	
			Register (Hex)	Words	Register (Hex)	Words
VOLTAGE & CURRENT HARMONICS & INTERHARMONICS MAGNITUDE&PHASE - fnom=50 Hz						
Interharmonic Group 25 - Bin 7 magnitude	03 / 04	0.001% / mV / mA	0504	2	B504	2
Interharmonic Group 25 - Bin 7 phase	03 / 04	0.001°	0506	2	B506	2
Interharmonic Group 25 - Bin 8 magnitude	03 / 04	0.001% / mV / mA	0508	2	B508	2
Interharmonic Group 25 - Bin 8 phase	03 / 04	0.001°	050A	2	B50A	2
Interharmonic Group 25 - Bin 9 magnitude	03 / 04	0.001% / mV / mA	050C	2	B50C	2
Interharmonic Group 25 - Bin 9 phase	03 / 04	0.001°	050E	2	B50E	2
26th Harmonic Component - Magnitude	03 / 04	0.001% / mV / mA	0510	2	B510	2
26th Harmonic Component - Phase	03 / 04	0.001°	0512	2	B512	2
Interharmonic Group 26 - Bin 1 magnitude	03 / 04	0.001% / mV / mA	0514	2	B514	2
Interharmonic Group 26 - Bin 1 phase	03 / 04	0.001°	0516	2	B516	2
Interharmonic Group 26 - Bin 2 magnitude	03 / 04	0.001% / mV / mA	0518	2	B518	2
Interharmonic Group 26 - Bin 2 phase	03 / 04	0.001°	051A	2	B51A	2
Interharmonic Group 26 - Bin 3 magnitude	03 / 04	0.001% / mV / mA	051C	2	B51C	2
Interharmonic Group 26 - Bin 3 phase	03 / 04	0.001°	051E	2	B51E	2
Interharmonic Group 26 - Bin 4 magnitude	03 / 04	0.001% / mV / mA	0520	2	B520	2
Interharmonic Group 26 - Bin 4 phase	03 / 04	0.001°	0522	2	B522	2
Interharmonic Group 26 - Bin 5 magnitude	03 / 04	0.001% / mV / mA	0524	2	B524	2
Interharmonic Group 26 - Bin 5 phase	03 / 04	0.001°	0526	2	B526	2
Interharmonic Group 26 - Bin 6 magnitude	03 / 04	0.001% / mV / mA	0528	2	B528	2
Interharmonic Group 26 - Bin 6 phase	03 / 04	0.001°	052A	2	B52A	2
Interharmonic Group 26 - Bin 7 magnitude	03 / 04	0.001% / mV / mA	052C	2	B52C	2
Interharmonic Group 26 - Bin 7 phase	03 / 04	0.001°	052E	2	B52E	2
Interharmonic Group 26 - Bin 8 magnitude	03 / 04	0.001% / mV / mA	0530	2	B530	2
Interharmonic Group 26 - Bin 8 phase	03 / 04	0.001°	0532	2	B532	2
Interharmonic Group 26 - Bin 9 magnitude	03 / 04	0.001% / mV / mA	0534	2	B534	2
Interharmonic Group 26 - Bin 9 phase	03 / 04	0.001°	0536	2	B536	2
27th Harmonic Component - Magnitude	03 / 04	0.001% / mV / mA	0538	2	B538	2
27th Harmonic Component - Phase	03 / 04	0.001°	053A	2	B53A	2
Interharmonic Group 27 - Bin 1 magnitude	03 / 04	0.001% / mV / mA	053C	2	B53C	2
Interharmonic Group 27 - Bin 1 phase	03 / 04	0.001°	053E	2	B53E	2
Interharmonic Group 27 - Bin 2 magnitude	03 / 04	0.001% / mV / mA	0540	2	B540	2
Interharmonic Group 27 - Bin 2 phase	03 / 04	0.001°	0542	2	B542	2
Interharmonic Group 27 - Bin 3 magnitude	03 / 04	0.001% / mV / mA	0544	2	B544	2
Interharmonic Group 27 - Bin 3 phase	03 / 04	0.001°	0546	2	B546	2
Interharmonic Group 27 - Bin 4 magnitude	03 / 04	0.001% / mV / mA	0548	2	B548	2
Interharmonic Group 27 - Bin 4 phase	03 / 04	0.001°	054A	2	B54A	2
Interharmonic Group 27 - Bin 5 magnitude	03 / 04	0.001% / mV / mA	054C	2	B54C	2
Interharmonic Group 27 - Bin 5 phase	03 / 04	0.001°	054E	2	B54E	2
Interharmonic Group 27 - Bin 6 magnitude	03 / 04	0.001% / mV / mA	0550	2	B550	2
Interharmonic Group 27 - Bin 6 phase	03 / 04	0.001°	0552	2	B552	2
Interharmonic Group 27 - Bin 7 magnitude	03 / 04	0.001% / mV / mA	0554	2	B554	2
Interharmonic Group 27 - Bin 7 phase	03 / 04	0.001°	0556	2	B556	2
Interharmonic Group 27 - Bin 8 magnitude	03 / 04	0.001% / mV / mA	0558	2	B558	2
Interharmonic Group 27 - Bin 8 phase	03 / 04	0.001°	055A	2	B55A	2
Interharmonic Group 27 - Bin 9 magnitude	03 / 04	0.001% / mV / mA	055C	2	B55C	2
Interharmonic Group 27 - Bin 9 phase	03 / 04	0.001°	055E	2	B55E	2
28th Harmonic Component - Magnitude	03 / 04	0.001% / mV / mA	0560	2	B560	2
28th Harmonic Component - Phase	03 / 04	0.001°	0562	2	B562	2
Interharmonic Group 28 - Bin 1 magnitude	03 / 04	0.001% / mV / mA	0564	2	B564	2
Interharmonic Group 28 - Bin 1 phase	03 / 04	0.001°	0566	2	B566	2

Parameter	F. code (Hex)	M.U.	INTEGER		IEEE	
			Register (Hex)	Words	Register (Hex)	Words
VOLTAGE & CURRENT HARMONICS & INTERHARMONICS MAGNITUDE&PHASE - fnom=50 Hz						
Interharmonic Group 28 - Bin 2 magnitude	03 / 04	0.001% / mV / mA	0568	2	B568	2
Interharmonic Group 28 - Bin 2 phase	03 / 04	0.001°	056A	2	B56A	2
Interharmonic Group 28 - Bin 3 magnitude	03 / 04	0.001% / mV / mA	056C	2	B56C	2
Interharmonic Group 28 - Bin 3 phase	03 / 04	0.001°	056E	2	B56E	2
Interharmonic Group 28 - Bin 4 magnitude	03 / 04	0.001% / mV / mA	0570	2	B570	2
Interharmonic Group 28 - Bin 4 phase	03 / 04	0.001°	0572	2	B572	2
Interharmonic Group 28 - Bin 5 magnitude	03 / 04	0.001% / mV / mA	0574	2	B574	2
Interharmonic Group 28 - Bin 5 phase	03 / 04	0.001°	0576	2	B576	2
Interharmonic Group 28 - Bin 6 magnitude	03 / 04	0.001% / mV / mA	0578	2	B578	2
Interharmonic Group 28 - Bin 6 phase	03 / 04	0.001°	057A	2	B57A	2
Interharmonic Group 28 - Bin 7 magnitude	03 / 04	0.001% / mV / mA	057C	2	B57C	2
Interharmonic Group 28 - Bin 7 phase	03 / 04	0.001°	057E	2	B57E	2
Interharmonic Group 28 - Bin 8 magnitude	03 / 04	0.001% / mV / mA	0580	2	B580	2
Interharmonic Group 28 - Bin 8 phase	03 / 04	0.001°	0582	2	B582	2
Interharmonic Group 28 - Bin 9 magnitude	03 / 04	0.001% / mV / mA	0584	2	B584	2
Interharmonic Group 28 - Bin 9 phase	03 / 04	0.001°	0586	2	B586	2
29th Harmonic Component - Magnitude	03 / 04	0.001% / mV / mA	0588	2	B588	2
29th Harmonic Component - Phase	03 / 04	0.001°	058A	2	B58A	2
Interharmonic Group 29 - Bin 1 magnitude	03 / 04	0.001% / mV / mA	058C	2	B58C	2
Interharmonic Group 29 - Bin 1 phase	03 / 04	0.001°	058E	2	B58E	2
Interharmonic Group 29 - Bin 2 magnitude	03 / 04	0.001% / mV / mA	0590	2	B590	2
Interharmonic Group 29 - Bin 2 phase	03 / 04	0.001°	0592	2	B592	2
Interharmonic Group 29 - Bin 3 magnitude	03 / 04	0.001% / mV / mA	0594	2	B594	2
Interharmonic Group 29 - Bin 3 phase	03 / 04	0.001°	0596	2	B596	2
Interharmonic Group 29 - Bin 4 magnitude	03 / 04	0.001% / mV / mA	0598	2	B598	2
Interharmonic Group 29 - Bin 4 phase	03 / 04	0.001°	059A	2	B59A	2
Interharmonic Group 29 - Bin 5 magnitude	03 / 04	0.001% / mV / mA	059C	2	B59C	2
Interharmonic Group 29 - Bin 5 phase	03 / 04	0.001°	059E	2	B59E	2
Interharmonic Group 29 - Bin 6 magnitude	03 / 04	0.001% / mV / mA	05A0	2	B5A0	2
Interharmonic Group 29 - Bin 6 phase	03 / 04	0.001°	05A2	2	B5A2	2
Interharmonic Group 29 - Bin 7 magnitude	03 / 04	0.001% / mV / mA	05A4	2	B5A4	2
Interharmonic Group 29 - Bin 7 phase	03 / 04	0.001°	05A6	2	B5A6	2
Interharmonic Group 29 - Bin 8 magnitude	03 / 04	0.001% / mV / mA	05A8	2	B5A8	2
Interharmonic Group 29 - Bin 8 phase	03 / 04	0.001°	05AA	2	B5AA	2
Interharmonic Group 29 - Bin 9 magnitude	03 / 04	0.001% / mV / mA	05AC	2	B5AC	2
Interharmonic Group 29 - Bin 9 phase	03 / 04	0.001°	05AE	2	B5AE	2
30th Harmonic Component - Magnitude	03 / 04	0.001% / mV / mA	05B0	2	B5B0	2
30th Harmonic Component - Phase	03 / 04	0.001°	05B2	2	B5B2	2
Interharmonic Group 30 - Bin 1 magnitude	03 / 04	0.001% / mV / mA	05B4	2	B5B4	2
Interharmonic Group 30 - Bin 1 phase	03 / 04	0.001°	05B6	2	B5B6	2
Interharmonic Group 30 - Bin 2 magnitude	03 / 04	0.001% / mV / mA	05B8	2	B5B8	2
Interharmonic Group 30 - Bin 2 phase	03 / 04	0.001°	05BA	2	B5BA	2
Interharmonic Group 30 - Bin 3 magnitude	03 / 04	0.001% / mV / mA	05BC	2	B5BC	2
Interharmonic Group 30 - Bin 3 phase	03 / 04	0.001°	05BE	2	B5BE	2
Interharmonic Group 30 - Bin 4 magnitude	03 / 04	0.001% / mV / mA	05C0	2	B5C0	2
Interharmonic Group 30 - Bin 4 phase	03 / 04	0.001°	05C2	2	B5C2	2
Interharmonic Group 30 - Bin 5 magnitude	03 / 04	0.001% / mV / mA	05C4	2	B5C4	2
Interharmonic Group 30 - Bin 5 phase	03 / 04	0.001°	05C6	2	B5C6	2
Interharmonic Group 30 - Bin 6 magnitude	03 / 04	0.001% / mV / mA	05C8	2	B5C8	2
Interharmonic Group 30 - Bin 6 phase	03 / 04	0.001°	05CA	2	B5CA	2

Parameter	F. code (Hex)	M.U.	INTEGER		IEEE	
			Register (Hex)	Words	Register (Hex)	Words
VOLTAGE & CURRENT HARMONICS & INTERHARMONICS MAGNITUDE&PHASE - fnom=50 Hz						
Interharmonic Group 30 - Bin 7 magnitude	03 / 04	0.001% / mV / mA	05CC	2	B5CC	2
Interharmonic Group 30 - Bin 7 phase	03 / 04	0.001°	05CE	2	B5CE	2
Interharmonic Group 30 - Bin 8 magnitude	03 / 04	0.001% / mV / mA	05D0	2	B5D0	2
Interharmonic Group 30 - Bin 8 phase	03 / 04	0.001°	05D2	2	B5D2	2
Interharmonic Group 30 - Bin 9 magnitude	03 / 04	0.001% / mV / mA	05D4	2	B5D4	2
Interharmonic Group 30 - Bin 9 phase	03 / 04	0.001°	05D6	2	B5D6	2
31st Harmonic Component - Magnitude	03 / 04	0.001% / mV / mA	05D8	2	B5D8	2
31st Harmonic Component - Phase	03 / 04	0.001°	05DA	2	B5DA	2
Interharmonic Group 31 - Bin 1 magnitude	03 / 04	0.001% / mV / mA	05DC	2	B5DC	2
Interharmonic Group 31 - Bin 1 phase	03 / 04	0.001°	05DE	2	B5DE	2
Interharmonic Group 31 - Bin 2 magnitude	03 / 04	0.001% / mV / mA	05E0	2	B5E0	2
Interharmonic Group 31 - Bin 2 phase	03 / 04	0.001°	05E2	2	B5E2	2
Interharmonic Group 31 - Bin 3 magnitude	03 / 04	0.001% / mV / mA	05E4	2	B5E4	2
Interharmonic Group 31 - Bin 3 phase	03 / 04	0.001°	05E6	2	B5E6	2
Interharmonic Group 31 - Bin 4 magnitude	03 / 04	0.001% / mV / mA	05E8	2	B5E8	2
Interharmonic Group 31 - Bin 4 phase	03 / 04	0.001°	05EA	2	B5EA	2
Interharmonic Group 31 - Bin 5 magnitude	03 / 04	0.001% / mV / mA	05EC	2	B5EC	2
Interharmonic Group 31 - Bin 5 phase	03 / 04	0.001°	05EE	2	B5EE	2
Interharmonic Group 31 - Bin 6 magnitude	03 / 04	0.001% / mV / mA	05F0	2	B5F0	2
Interharmonic Group 31 - Bin 6 phase	03 / 04	0.001°	05F2	2	B5F2	2
Interharmonic Group 31 - Bin 7 magnitude	03 / 04	0.001% / mV / mA	05F4	2	B5F4	2
Interharmonic Group 31 - Bin 7 phase	03 / 04	0.001°	05F6	2	B5F6	2
Interharmonic Group 31 - Bin 8 magnitude	03 / 04	0.001% / mV / mA	05F8	2	B5F8	2
Interharmonic Group 31 - Bin 8 phase	03 / 04	0.001°	05FA	2	B5FA	2
Interharmonic Group 31 - Bin 9 magnitude	03 / 04	0.001% / mV / mA	05FC	2	B5FC	2
Interharmonic Group 31 - Bin 9 phase	03 / 04	0.001°	05FE	2	B5FE	2
32nd Harmonic Component - Magnitude	03 / 04	0.001% / mV / mA	0600	2	B600	2
32nd Harmonic Component - Phase	03 / 04	0.001°	0602	2	B602	2
Interharmonic Group 32 - Bin 1 magnitude	03 / 04	0.001% / mV / mA	0604	2	B604	2
Interharmonic Group 32 - Bin 1 phase	03 / 04	0.001°	0606	2	B606	2
Interharmonic Group 32 - Bin 2 magnitude	03 / 04	0.001% / mV / mA	0608	2	B608	2
Interharmonic Group 32 - Bin 2 phase	03 / 04	0.001°	060A	2	B60A	2
Interharmonic Group 32 - Bin 3 magnitude	03 / 04	0.001% / mV / mA	060C	2	B60C	2
Interharmonic Group 32 - Bin 3 phase	03 / 04	0.001°	060E	2	B60E	2
Interharmonic Group 32 - Bin 4 magnitude	03 / 04	0.001% / mV / mA	0610	2	B610	2
Interharmonic Group 32 - Bin 4 phase	03 / 04	0.001°	0612	2	B612	2
Interharmonic Group 32 - Bin 5 magnitude	03 / 04	0.001% / mV / mA	0614	2	B614	2
Interharmonic Group 32 - Bin 5 phase	03 / 04	0.001°	0616	2	B616	2
Interharmonic Group 32 - Bin 6 magnitude	03 / 04	0.001% / mV / mA	0618	2	B618	2
Interharmonic Group 32 - Bin 6 phase	03 / 04	0.001°	061A	2	B61A	2
Interharmonic Group 32 - Bin 7 magnitude	03 / 04	0.001% / mV / mA	061C	2	B61C	2
Interharmonic Group 32 - Bin 7 phase	03 / 04	0.001°	061E	2	B61E	2
Interharmonic Group 32 - Bin 8 magnitude	03 / 04	0.001% / mV / mA	0620	2	B620	2
Interharmonic Group 32 - Bin 8 phase	03 / 04	0.001°	0622	2	B622	2
Interharmonic Group 32 - Bin 9 magnitude	03 / 04	0.001% / mV / mA	0624	2	B624	2
Interharmonic Group 32 - Bin 9 phase	03 / 04	0.001°	0626	2	B626	2
33rd Harmonic Component - Magnitude	03 / 04	0.001% / mV / mA	0628	2	B628	2
33rd Harmonic Component - Phase	03 / 04	0.001°	062A	2	B62A	2
Interharmonic Group 33 - Bin 1 magnitude	03 / 04	0.001% / mV / mA	062C	2	B62C	2
Interharmonic Group 33 - Bin 1 phase	03 / 04	0.001°	062E	2	B62E	2

Parameter	F. code (Hex)	M.U.	INTEGER		IEEE	
			Register (Hex)	Words	Register (Hex)	Words
VOLTAGE & CURRENT HARMONICS & INTERHARMONICS MAGNITUDE&PHASE - f_{nom}=50 Hz						
Interharmonic Group 33 - Bin 2 magnitude	03 / 04	0.001% / mV / mA	0630	2	B630	2
Interharmonic Group 33 - Bin 2 phase	03 / 04	0.001°	0632	2	B632	2
Interharmonic Group 33 - Bin 3 magnitude	03 / 04	0.001% / mV / mA	0634	2	B634	2
Interharmonic Group 33 - Bin 3 phase	03 / 04	0.001°	0636	2	B636	2
Interharmonic Group 33 - Bin 4 magnitude	03 / 04	0.001% / mV / mA	0638	2	B638	2
Interharmonic Group 33 - Bin 4 phase	03 / 04	0.001°	063A	2	B63A	2
Interharmonic Group 33 - Bin 5 magnitude	03 / 04	0.001% / mV / mA	063C	2	B63C	2
Interharmonic Group 33 - Bin 5 phase	03 / 04	0.001°	063E	2	B63E	2
Interharmonic Group 33 - Bin 6 magnitude	03 / 04	0.001% / mV / mA	0640	2	B640	2
Interharmonic Group 33 - Bin 6 phase	03 / 04	0.001°	0642	2	B642	2
Interharmonic Group 33 - Bin 7 magnitude	03 / 04	0.001% / mV / mA	0644	2	B644	2
Interharmonic Group 33 - Bin 7 phase	03 / 04	0.001°	0646	2	B646	2
Interharmonic Group 33 - Bin 8 magnitude	03 / 04	0.001% / mV / mA	0648	2	B648	2
Interharmonic Group 33 - Bin 8 phase	03 / 04	0.001°	064A	2	B64A	2
Interharmonic Group 33 - Bin 9 magnitude	03 / 04	0.001% / mV / mA	064C	2	B64C	2
Interharmonic Group 33 - Bin 9 phase	03 / 04	0.001°	064E	2	B64E	2
34th Harmonic Component - Magnitude	03 / 04	0.001% / mV / mA	0650	2	B650	2
34th Harmonic Component - Phase	03 / 04	0.001°	0652	2	B652	2
Interharmonic Group 34 - Bin 1 magnitude	03 / 04	0.001% / mV / mA	0654	2	B654	2
Interharmonic Group 34 - Bin 1 phase	03 / 04	0.001°	0656	2	B656	2
Interharmonic Group 34 - Bin 2 magnitude	03 / 04	0.001% / mV / mA	0658	2	B658	2
Interharmonic Group 34 - Bin 2 phase	03 / 04	0.001°	065A	2	B65A	2
Interharmonic Group 34 - Bin 3 magnitude	03 / 04	0.001% / mV / mA	065C	2	B65C	2
Interharmonic Group 34 - Bin 3 phase	03 / 04	0.001°	065E	2	B65E	2
Interharmonic Group 34 - Bin 4 magnitude	03 / 04	0.001% / mV / mA	0660	2	B660	2
Interharmonic Group 34 - Bin 4 phase	03 / 04	0.001°	0662	2	B662	2
Interharmonic Group 34 - Bin 5 magnitude	03 / 04	0.001% / mV / mA	0664	2	B664	2
Interharmonic Group 34 - Bin 5 phase	03 / 04	0.001°	0666	2	B666	2
Interharmonic Group 34 - Bin 6 magnitude	03 / 04	0.001% / mV / mA	0668	2	B668	2
Interharmonic Group 34 - Bin 6 phase	03 / 04	0.001°	066A	2	B66A	2
Interharmonic Group 34 - Bin 7 magnitude	03 / 04	0.001% / mV / mA	066C	2	B66C	2
Interharmonic Group 34 - Bin 7 phase	03 / 04	0.001°	066E	2	B66E	2
Interharmonic Group 34 - Bin 8 magnitude	03 / 04	0.001% / mV / mA	0670	2	B670	2
Interharmonic Group 34 - Bin 8 phase	03 / 04	0.001°	0672	2	B672	2
Interharmonic Group 34 - Bin 9 magnitude	03 / 04	0.001% / mV / mA	0674	2	B674	2
Interharmonic Group 34 - Bin 9 phase	03 / 04	0.001°	0676	2	B676	2
35th Harmonic Component - Magnitude	03 / 04	0.001% / mV / mA	0678	2	B678	2
35th Harmonic Component - Phase	03 / 04	0.001°	067A	2	B67A	2
Interharmonic Group 35 - Bin 1 magnitude	03 / 04	0.001% / mV / mA	067C	2	B67C	2
Interharmonic Group 35 - Bin 1 phase	03 / 04	0.001°	067E	2	B67E	2
Interharmonic Group 35 - Bin 2 magnitude	03 / 04	0.001% / mV / mA	0680	2	B680	2
Interharmonic Group 35 - Bin 2 phase	03 / 04	0.001°	0682	2	B682	2
Interharmonic Group 35 - Bin 3 magnitude	03 / 04	0.001% / mV / mA	0684	2	B684	2
Interharmonic Group 35 - Bin 3 phase	03 / 04	0.001°	0686	2	B686	2
Interharmonic Group 35 - Bin 4 magnitude	03 / 04	0.001% / mV / mA	0688	2	B688	2
Interharmonic Group 35 - Bin 4 phase	03 / 04	0.001°	068A	2	B68A	2
Interharmonic Group 35 - Bin 5 magnitude	03 / 04	0.001% / mV / mA	068C	2	B68C	2
Interharmonic Group 35 - Bin 5 phase	03 / 04	0.001°	068E	2	B68E	2
Interharmonic Group 35 - Bin 6 magnitude	03 / 04	0.001% / mV / mA	0690	2	B690	2
Interharmonic Group 35 - Bin 6 phase	03 / 04	0.001°	0692	2	B692	2

Parameter	F. code (Hex)	M.U.	INTEGER		IEEE	
			Register (Hex)	Words	Register (Hex)	Words
VOLTAGE & CURRENT HARMONICS & INTERHARMONICS MAGNITUDE&PHASE - f_{nom}=50 Hz						
Interharmonic Group 35 - Bin 7 magnitude	03 / 04	0.001% / mV / mA	0694	2	B694	2
Interharmonic Group 35 - Bin 7 phase	03 / 04	0.001°	0696	2	B696	2
Interharmonic Group 35 - Bin 8 magnitude	03 / 04	0.001% / mV / mA	0698	2	B698	2
Interharmonic Group 35 - Bin 8 phase	03 / 04	0.001°	069A	2	B69A	2
Interharmonic Group 35 - Bin 9 magnitude	03 / 04	0.001% / mV / mA	069C	2	B69C	2
Interharmonic Group 35 - Bin 9 phase	03 / 04	0.001°	069E	2	B69E	2
36th Harmonic Component - Magnitude	03 / 04	0.001% / mV / mA	06A0	2	B6A0	2
36th Harmonic Component - Phase	03 / 04	0.001°	06A2	2	B6A2	2
Interharmonic Group 36 - Bin 1 magnitude	03 / 04	0.001% / mV / mA	06A4	2	B6A4	2
Interharmonic Group 36 - Bin 1 phase	03 / 04	0.001°	06A6	2	B6A6	2
Interharmonic Group 36 - Bin 2 magnitude	03 / 04	0.001% / mV / mA	06A8	2	B6A8	2
Interharmonic Group 36 - Bin 2 phase	03 / 04	0.001°	06AA	2	B6AA	2
Interharmonic Group 36 - Bin 3 magnitude	03 / 04	0.001% / mV / mA	06AC	2	B6AC	2
Interharmonic Group 36 - Bin 3 phase	03 / 04	0.001°	06AE	2	B6AE	2
Interharmonic Group 36 - Bin 4 magnitude	03 / 04	0.001% / mV / mA	06B0	2	B6B0	2
Interharmonic Group 36 - Bin 4 phase	03 / 04	0.001°	06B2	2	B6B2	2
Interharmonic Group 36 - Bin 5 magnitude	03 / 04	0.001% / mV / mA	06B4	2	B6B4	2
Interharmonic Group 36 - Bin 5 phase	03 / 04	0.001°	06B6	2	B6B6	2
Interharmonic Group 36 - Bin 6 magnitude	03 / 04	0.001% / mV / mA	06B8	2	B6B8	2
Interharmonic Group 36 - Bin 6 phase	03 / 04	0.001°	06BA	2	B6BA	2
Interharmonic Group 36 - Bin 7 magnitude	03 / 04	0.001% / mV / mA	06BC	2	B6BC	2
Interharmonic Group 36 - Bin 7 phase	03 / 04	0.001°	06BE	2	B6BE	2
Interharmonic Group 36 - Bin 8 magnitude	03 / 04	0.001% / mV / mA	06C0	2	B6C0	2
Interharmonic Group 36 - Bin 8 phase	03 / 04	0.001°	06C2	2	B6C2	2
Interharmonic Group 36 - Bin 9 magnitude	03 / 04	0.001% / mV / mA	06C4	2	B6C4	2
Interharmonic Group 36 - Bin 9 phase	03 / 04	0.001°	06C6	2	B6C6	2
37th Harmonic Component - Magnitude	03 / 04	0.001% / mV / mA	06C8	2	B6C8	2
37th Harmonic Component - Phase	03 / 04	0.001°	06CA	2	B6CA	2
Interharmonic Group 37 - Bin 1 magnitude	03 / 04	0.001% / mV / mA	06CC	2	B6CC	2
Interharmonic Group 37 - Bin 1 phase	03 / 04	0.001°	06CE	2	B6CE	2
Interharmonic Group 37 - Bin 2 magnitude	03 / 04	0.001% / mV / mA	06D0	2	B6D0	2
Interharmonic Group 37 - Bin 2 phase	03 / 04	0.001°	06D2	2	B6D2	2
Interharmonic Group 37 - Bin 3 magnitude	03 / 04	0.001% / mV / mA	06D4	2	B6D4	2
Interharmonic Group 37 - Bin 3 phase	03 / 04	0.001°	06D6	2	B6D6	2
Interharmonic Group 37 - Bin 4 magnitude	03 / 04	0.001% / mV / mA	06D8	2	B6D8	2
Interharmonic Group 37 - Bin 4 phase	03 / 04	0.001°	06DA	2	B6DA	2
Interharmonic Group 37 - Bin 5 magnitude	03 / 04	0.001% / mV / mA	06DC	2	B6DC	2
Interharmonic Group 37 - Bin 5 phase	03 / 04	0.001°	06DE	2	B6DE	2
Interharmonic Group 37 - Bin 6 magnitude	03 / 04	0.001% / mV / mA	06E0	2	B6E0	2
Interharmonic Group 37 - Bin 6 phase	03 / 04	0.001°	06E2	2	B6E2	2
Interharmonic Group 37 - Bin 7 magnitude	03 / 04	0.001% / mV / mA	06E4	2	B6E4	2
Interharmonic Group 37 - Bin 7 phase	03 / 04	0.001°	06E6	2	B6E6	2
Interharmonic Group 37 - Bin 8 magnitude	03 / 04	0.001% / mV / mA	06E8	2	B6E8	2
Interharmonic Group 37 - Bin 8 phase	03 / 04	0.001°	06EA	2	B6EA	2
Interharmonic Group 37 - Bin 9 magnitude	03 / 04	0.001% / mV / mA	06EC	2	B6EC	2
Interharmonic Group 37 - Bin 9 phase	03 / 04	0.001°	06EE	2	B6EE	2
38th Harmonic Component - Magnitude	03 / 04	0.001% / mV / mA	06F0	2	B6F0	2
38th Harmonic Component - Phase	03 / 04	0.001°	06F2	2	B6F2	2
Interharmonic Group 38 - Bin 1 magnitude	03 / 04	0.001% / mV / mA	06F4	2	B6F4	2
Interharmonic Group 38 - Bin 1 phase	03 / 04	0.001°	06F6	2	B6F6	2

Parameter	F. code (Hex)	M.U.	INTEGER		IEEE	
			Register (Hex)	Words	Register (Hex)	Words
VOLTAGE & CURRENT HARMONICS & INTERHARMONICS MAGNITUDE&PHASE - fnom=50 Hz						
Interharmonic Group 38 - Bin 2 magnitude	03 / 04	0.001% / mV / mA	06F8	2	B6F8	2
Interharmonic Group 38 - Bin 2 phase	03 / 04	0.001°	06FA	2	B6FA	2
Interharmonic Group 38 - Bin 3 magnitude	03 / 04	0.001% / mV / mA	06FC	2	B6FC	2
Interharmonic Group 38 - Bin 3 phase	03 / 04	0.001°	06FE	2	B6FE	2
Interharmonic Group 38 - Bin 4 magnitude	03 / 04	0.001% / mV / mA	0700	2	B700	2
Interharmonic Group 38 - Bin 4 phase	03 / 04	0.001°	0702	2	B702	2
Interharmonic Group 38 - Bin 5 magnitude	03 / 04	0.001% / mV / mA	0704	2	B704	2
Interharmonic Group 38 - Bin 5 phase	03 / 04	0.001°	0706	2	B706	2
Interharmonic Group 38 - Bin 6 magnitude	03 / 04	0.001% / mV / mA	0708	2	B708	2
Interharmonic Group 38 - Bin 6 phase	03 / 04	0.001°	070A	2	B70A	2
Interharmonic Group 38 - Bin 7 magnitude	03 / 04	0.001% / mV / mA	070C	2	B70C	2
Interharmonic Group 38 - Bin 7 phase	03 / 04	0.001°	070E	2	B70E	2
Interharmonic Group 38 - Bin 8 magnitude	03 / 04	0.001% / mV / mA	0710	2	B710	2
Interharmonic Group 38 - Bin 8 phase	03 / 04	0.001°	0712	2	B712	2
Interharmonic Group 38 - Bin 9 magnitude	03 / 04	0.001% / mV / mA	0714	2	B714	2
Interharmonic Group 38 - Bin 9 phase	03 / 04	0.001°	0716	2	B716	2
39th Harmonic Component - Magnitude	03 / 04	0.001% / mV / mA	0718	2	B718	2
39th Harmonic Component - Phase	03 / 04	0.001°	071A	2	B71A	2
Interharmonic Group 39 - Bin 1 magnitude	03 / 04	0.001% / mV / mA	071C	2	B71C	2
Interharmonic Group 39 - Bin 1 phase	03 / 04	0.001°	071E	2	B71E	2
Interharmonic Group 39 - Bin 2 magnitude	03 / 04	0.001% / mV / mA	0720	2	B720	2
Interharmonic Group 39 - Bin 2 phase	03 / 04	0.001°	0722	2	B722	2
Interharmonic Group 39 - Bin 3 magnitude	03 / 04	0.001% / mV / mA	0724	2	B724	2
Interharmonic Group 39 - Bin 3 phase	03 / 04	0.001°	0726	2	B726	2
Interharmonic Group 39 - Bin 4 magnitude	03 / 04	0.001% / mV / mA	0728	2	B728	2
Interharmonic Group 39 - Bin 4 phase	03 / 04	0.001°	072A	2	B72A	2
Interharmonic Group 39 - Bin 5 magnitude	03 / 04	0.001% / mV / mA	072C	2	B72C	2
Interharmonic Group 39 - Bin 5 phase	03 / 04	0.001°	072E	2	B72E	2
Interharmonic Group 39 - Bin 6 magnitude	03 / 04	0.001% / mV / mA	0730	2	B730	2
Interharmonic Group 39 - Bin 6 phase	03 / 04	0.001°	0732	2	B732	2
Interharmonic Group 39 - Bin 7 magnitude	03 / 04	0.001% / mV / mA	0734	2	B734	2
Interharmonic Group 39 - Bin 7 phase	03 / 04	0.001°	0736	2	B736	2
Interharmonic Group 39 - Bin 8 magnitude	03 / 04	0.001% / mV / mA	0738	2	B738	2
Interharmonic Group 39 - Bin 8 phase	03 / 04	0.001°	073A	2	B73A	2
Interharmonic Group 39 - Bin 9 magnitude	03 / 04	0.001% / mV / mA	073C	2	B73C	2
Interharmonic Group 39 - Bin 9 phase	03 / 04	0.001°	073E	2	B73E	2
40th Harmonic Component - Magnitude	03 / 04	0.001% / mV / mA	0740	2	B740	2
40th Harmonic Component - Phase	03 / 04	0.001°	0742	2	B742	2
Interharmonic Group 40 - Bin 1 magnitude	03 / 04	0.001% / mV / mA	0744	2	B744	2
Interharmonic Group 40 - Bin 1 phase	03 / 04	0.001°	0746	2	B746	2
Interharmonic Group 40 - Bin 2 magnitude	03 / 04	0.001% / mV / mA	0748	2	B748	2
Interharmonic Group 40 - Bin 2 phase	03 / 04	0.001°	074A	2	B74A	2
Interharmonic Group 40 - Bin 3 magnitude	03 / 04	0.001% / mV / mA	074C	2	B74C	2
Interharmonic Group 40 - Bin 3 phase	03 / 04	0.001°	074E	2	B74E	2
Interharmonic Group 40 - Bin 4 magnitude	03 / 04	0.001% / mV / mA	0750	2	B750	2
Interharmonic Group 40 - Bin 4 phase	03 / 04	0.001°	0752	2	B752	2
Interharmonic Group 40 - Bin 5 magnitude	03 / 04	0.001% / mV / mA	0754	2	B754	2
Interharmonic Group 40 - Bin 5 phase	03 / 04	0.001°	0756	2	B756	2
Interharmonic Group 40 - Bin 6 magnitude	03 / 04	0.001% / mV / mA	0758	2	B758	2
Interharmonic Group 40 - Bin 6 phase	03 / 04	0.001°	075A	2	B75A	2

Parameter	F. code (Hex)	M.U.	INTEGER		IEEE	
			Register (Hex)	Words	Register (Hex)	Words
VOLTAGE & CURRENT HARMONICS & INTERHARMONICS MAGNITUDE&PHASE - fnom=50 Hz						
Interharmonic Group 40 - Bin 7 magnitude	03 / 04	0.001% / mV / mA	075C	2	B75C	2
Interharmonic Group 40 - Bin 7 phase	03 / 04	0.001°	075E	2	B75E	2
Interharmonic Group 40 - Bin 8 magnitude	03 / 04	0.001% / mV / mA	0760	2	B760	2
Interharmonic Group 40 - Bin 8 phase	03 / 04	0.001°	0762	2	B762	2
Interharmonic Group 40 - Bin 9 magnitude	03 / 04	0.001% / mV / mA	0764	2	B764	2
Interharmonic Group 40 - Bin 9 phase	03 / 04	0.001°	0766	2	B766	2
41st Harmonic Component - Magnitude	03 / 04	0.001% / mV / mA	0768	2	B768	2
41st Harmonic Component - Phase	03 / 04	0.001°	076A	2	B76A	2
Interharmonic Group 41 - Bin 1 magnitude	03 / 04	0.001% / mV / mA	076C	2	B76C	2
Interharmonic Group 41 - Bin 1 phase	03 / 04	0.001°	076E	2	B76E	2
Interharmonic Group 41 - Bin 2 magnitude	03 / 04	0.001% / mV / mA	0770	2	B770	2
Interharmonic Group 41 - Bin 2 phase	03 / 04	0.001°	0772	2	B772	2
Interharmonic Group 41 - Bin 3 magnitude	03 / 04	0.001% / mV / mA	0774	2	B774	2
Interharmonic Group 41 - Bin 3 phase	03 / 04	0.001°	0776	2	B776	2
Interharmonic Group 41 - Bin 4 magnitude	03 / 04	0.001% / mV / mA	0778	2	B778	2
Interharmonic Group 41 - Bin 4 phase	03 / 04	0.001°	077A	2	B77A	2
Interharmonic Group 41 - Bin 5 magnitude	03 / 04	0.001% / mV / mA	077C	2	B77C	2
Interharmonic Group 41 - Bin 5 phase	03 / 04	0.001°	077E	2	B77E	2
Interharmonic Group 41 - Bin 6 magnitude	03 / 04	0.001% / mV / mA	0780	2	B780	2
Interharmonic Group 41 - Bin 6 phase	03 / 04	0.001°	0782	2	B782	2
Interharmonic Group 41 - Bin 7 magnitude	03 / 04	0.001% / mV / mA	0784	2	B784	2
Interharmonic Group 41 - Bin 7 phase	03 / 04	0.001°	0786	2	B786	2
Interharmonic Group 41 - Bin 8 magnitude	03 / 04	0.001% / mV / mA	0788	2	B788	2
Interharmonic Group 41 - Bin 8 phase	03 / 04	0.001°	078A	2	B78A	2
Interharmonic Group 41 - Bin 9 magnitude	03 / 04	0.001% / mV / mA	078C	2	B78C	2
Interharmonic Group 41 - Bin 9 phase	03 / 04	0.001°	078E	2	B78E	2
42nd Harmonic Component - Magnitude	03 / 04	0.001% / mV / mA	0790	2	B790	2
42nd Harmonic Component - Phase	03 / 04	0.001°	0792	2	B792	2
Interharmonic Group 42 - Bin 1 magnitude	03 / 04	0.001% / mV / mA	0794	2	B794	2
Interharmonic Group 42 - Bin 1 phase	03 / 04	0.001°	0796	2	B796	2
Interharmonic Group 42 - Bin 2 magnitude	03 / 04	0.001% / mV / mA	0798	2	B798	2
Interharmonic Group 42 - Bin 2 phase	03 / 04	0.001°	079A	2	B79A	2
Interharmonic Group 42 - Bin 3 magnitude	03 / 04	0.001% / mV / mA	079C	2	B79C	2
Interharmonic Group 42 - Bin 3 phase	03 / 04	0.001°	079E	2	B79E	2
Interharmonic Group 42 - Bin 4 magnitude	03 / 04	0.001% / mV / mA	07A0	2	B7A0	2
Interharmonic Group 42 - Bin 4 phase	03 / 04	0.001°	07A2	2	B7A2	2
Interharmonic Group 42 - Bin 5 magnitude	03 / 04	0.001% / mV / mA	07A4	2	B7A4	2
Interharmonic Group 42 - Bin 5 phase	03 / 04	0.001°	07A6	2	B7A6	2
Interharmonic Group 42 - Bin 6 magnitude	03 / 04	0.001% / mV / mA	07A8	2	B7A8	2
Interharmonic Group 42 - Bin 6 phase	03 / 04	0.001°	07AA	2	B7AA	2
Interharmonic Group 42 - Bin 7 magnitude	03 / 04	0.001% / mV / mA	07AC	2	B7AC	2
Interharmonic Group 42 - Bin 7 phase	03 / 04	0.001°	07AE	2	B7AE	2
Interharmonic Group 42 - Bin 8 magnitude	03 / 04	0.001% / mV / mA	07B0	2	B7B0	2
Interharmonic Group 42 - Bin 8 phase	03 / 04	0.001°	07B2	2	B7B2	2
Interharmonic Group 42 - Bin 9 magnitude	03 / 04	0.001% / mV / mA	07B4	2	B7B4	2
Interharmonic Group 42 - Bin 9 phase	03 / 04	0.001°	07B6	2	B7B6	2
43rd Harmonic Component - Magnitude	03 / 04	0.001% / mV / mA	07B8	2	B7B8	2
43rd Harmonic Component - Phase	03 / 04	0.001°	07BA	2	B7BA	2
Interharmonic Group 43 - Bin 1 magnitude	03 / 04	0.001% / mV / mA	07BC	2	B7BC	2
Interharmonic Group 43 - Bin 1 phase	03 / 04	0.001°	07BE	2	B7BE	2

Parameter	F. code (Hex)	M.U.	INTEGER		IEEE	
			Register (Hex)	Words	Register (Hex)	Words
VOLTAGE & CURRENT HARMONICS & INTERHARMONICS MAGNITUDE&PHASE - f_{nom}=50 Hz						
Interharmonic Group 43 - Bin 2 magnitude	03 / 04	0.001% / mV / mA	07C0	2	B7C0	2
Interharmonic Group 43 - Bin 2 phase	03 / 04	0.001°	07C2	2	B7C2	2
Interharmonic Group 43 - Bin 3 magnitude	03 / 04	0.001% / mV / mA	07C4	2	B7C4	2
Interharmonic Group 43 - Bin 3 phase	03 / 04	0.001°	07C6	2	B7C6	2
Interharmonic Group 43 - Bin 4 magnitude	03 / 04	0.001% / mV / mA	07C8	2	B7C8	2
Interharmonic Group 43 - Bin 4 phase	03 / 04	0.001°	07CA	2	B7CA	2
Interharmonic Group 43 - Bin 5 magnitude	03 / 04	0.001% / mV / mA	07CC	2	B7CC	2
Interharmonic Group 43 - Bin 5 phase	03 / 04	0.001°	07CE	2	B7CE	2
Interharmonic Group 43 - Bin 6 magnitude	03 / 04	0.001% / mV / mA	07D0	2	B7D0	2
Interharmonic Group 43 - Bin 6 phase	03 / 04	0.001°	07D2	2	B7D2	2
Interharmonic Group 43 - Bin 7 magnitude	03 / 04	0.001% / mV / mA	07D4	2	B7D4	2
Interharmonic Group 43 - Bin 7 phase	03 / 04	0.001°	07D6	2	B7D6	2
Interharmonic Group 43 - Bin 8 magnitude	03 / 04	0.001% / mV / mA	07D8	2	B7D8	2
Interharmonic Group 43 - Bin 8 phase	03 / 04	0.001°	07DA	2	B7DA	2
Interharmonic Group 43 - Bin 9 magnitude	03 / 04	0.001% / mV / mA	07DC	2	B7DC	2
Interharmonic Group 43 - Bin 9 phase	03 / 04	0.001°	07DE	2	B7DE	2
44th Harmonic Component - Magnitude	03 / 04	0.001% / mV / mA	07E0	2	B7E0	2
44th Harmonic Component - Phase	03 / 04	0.001°	07E2	2	B7E2	2
Interharmonic Group 44 - Bin 1 magnitude	03 / 04	0.001% / mV / mA	07E4	2	B7E4	2
Interharmonic Group 44 - Bin 1 phase	03 / 04	0.001°	07E6	2	B7E6	2
Interharmonic Group 44 - Bin 2 magnitude	03 / 04	0.001% / mV / mA	07E8	2	B7E8	2
Interharmonic Group 44 - Bin 2 phase	03 / 04	0.001°	07EA	2	B7EA	2
Interharmonic Group 44 - Bin 3 magnitude	03 / 04	0.001% / mV / mA	07EC	2	B7EC	2
Interharmonic Group 44 - Bin 3 phase	03 / 04	0.001°	07EE	2	B7EE	2
Interharmonic Group 44 - Bin 4 magnitude	03 / 04	0.001% / mV / mA	07F0	2	B7F0	2
Interharmonic Group 44 - Bin 4 phase	03 / 04	0.001°	07F2	2	B7F2	2
Interharmonic Group 44 - Bin 5 magnitude	03 / 04	0.001% / mV / mA	07F4	2	B7F4	2
Interharmonic Group 44 - Bin 5 phase	03 / 04	0.001°	07F6	2	B7F6	2
Interharmonic Group 44 - Bin 6 magnitude	03 / 04	0.001% / mV / mA	07F8	2	B7F8	2
Interharmonic Group 44 - Bin 6 phase	03 / 04	0.001°	07FA	2	B7FA	2
Interharmonic Group 44 - Bin 7 magnitude	03 / 04	0.001% / mV / mA	07FC	2	B7FC	2
Interharmonic Group 44 - Bin 7 phase	03 / 04	0.001°	07FE	2	B7FE	2
Interharmonic Group 44 - Bin 8 magnitude	03 / 04	0.001% / mV / mA	0800	2	B800	2
Interharmonic Group 44 - Bin 8 phase	03 / 04	0.001°	0802	2	B802	2
Interharmonic Group 44 - Bin 9 magnitude	03 / 04	0.001% / mV / mA	0804	2	B804	2
Interharmonic Group 44 - Bin 9 phase	03 / 04	0.001°	0806	2	B806	2
45th Harmonic Component - Magnitude	03 / 04	0.001% / mV / mA	0808	2	B808	2
45th Harmonic Component - Phase	03 / 04	0.001°	080A	2	B80A	2
Interharmonic Group 45 - Bin 1 magnitude	03 / 04	0.001% / mV / mA	080C	2	B80C	2
Interharmonic Group 45 - Bin 1 phase	03 / 04	0.001°	080E	2	B80E	2
Interharmonic Group 45 - Bin 2 magnitude	03 / 04	0.001% / mV / mA	0810	2	B810	2
Interharmonic Group 45 - Bin 2 phase	03 / 04	0.001°	0812	2	B812	2
Interharmonic Group 45 - Bin 3 magnitude	03 / 04	0.001% / mV / mA	0814	2	B814	2
Interharmonic Group 45 - Bin 3 phase	03 / 04	0.001°	0816	2	B816	2
Interharmonic Group 45 - Bin 4 magnitude	03 / 04	0.001% / mV / mA	0818	2	B818	2
Interharmonic Group 45 - Bin 4 phase	03 / 04	0.001°	081A	2	B81A	2
Interharmonic Group 45 - Bin 5 magnitude	03 / 04	0.001% / mV / mA	081C	2	B81C	2
Interharmonic Group 45 - Bin 5 phase	03 / 04	0.001°	081E	2	B81E	2
Interharmonic Group 45 - Bin 6 magnitude	03 / 04	0.001% / mV / mA	0820	2	B820	2
Interharmonic Group 45 - Bin 6 phase	03 / 04	0.001°	0822	2	B822	2

Parameter	F. code (Hex)	M.U.	INTEGER		IEEE	
			Register (Hex)	Words	Register (Hex)	Words
VOLTAGE & CURRENT HARMONICS & INTERHARMONICS MAGNITUDE&PHASE - fnom=50 Hz						
Interharmonic Group 45 - Bin 7 magnitude	03 / 04	0.001% / mV / mA	0824	2	B824	2
Interharmonic Group 45 - Bin 7 phase	03 / 04	0.001°	0826	2	B826	2
Interharmonic Group 45 - Bin 8 magnitude	03 / 04	0.001% / mV / mA	0828	2	B828	2
Interharmonic Group 45 - Bin 8 phase	03 / 04	0.001°	082A	2	B82A	2
Interharmonic Group 45 - Bin 9 magnitude	03 / 04	0.001% / mV / mA	082C	2	B82C	2
Interharmonic Group 45 - Bin 9 phase	03 / 04	0.001°	082E	2	B82E	2
46th Harmonic Component - Magnitude	03 / 04	0.001% / mV / mA	0830	2	B830	2
46th Harmonic Component - Phase	03 / 04	0.001°	0832	2	B832	2
Interharmonic Group 46 - Bin 1 magnitude	03 / 04	0.001% / mV / mA	0834	2	B834	2
Interharmonic Group 46 - Bin 1 phase	03 / 04	0.001°	0836	2	B836	2
Interharmonic Group 46 - Bin 2 magnitude	03 / 04	0.001% / mV / mA	0838	2	B838	2
Interharmonic Group 46 - Bin 2 phase	03 / 04	0.001°	083A	2	B83A	2
Interharmonic Group 46 - Bin 3 magnitude	03 / 04	0.001% / mV / mA	083C	2	B83C	2
Interharmonic Group 46 - Bin 3 phase	03 / 04	0.001°	083E	2	B83E	2
Interharmonic Group 46 - Bin 4 magnitude	03 / 04	0.001% / mV / mA	0840	2	B840	2
Interharmonic Group 46 - Bin 4 phase	03 / 04	0.001°	0842	2	B842	2
Interharmonic Group 46 - Bin 5 magnitude	03 / 04	0.001% / mV / mA	0844	2	B844	2
Interharmonic Group 46 - Bin 5 phase	03 / 04	0.001°	0846	2	B846	2
Interharmonic Group 46 - Bin 6 magnitude	03 / 04	0.001% / mV / mA	0848	2	B848	2
Interharmonic Group 46 - Bin 6 phase	03 / 04	0.001°	084A	2	B84A	2
Interharmonic Group 46 - Bin 7 magnitude	03 / 04	0.001% / mV / mA	084C	2	B84C	2
Interharmonic Group 46 - Bin 7 phase	03 / 04	0.001°	084E	2	B84E	2
Interharmonic Group 46 - Bin 8 magnitude	03 / 04	0.001% / mV / mA	0850	2	B850	2
Interharmonic Group 46 - Bin 8 phase	03 / 04	0.001°	0852	2	B852	2
Interharmonic Group 46 - Bin 9 magnitude	03 / 04	0.001% / mV / mA	0854	2	B854	2
Interharmonic Group 46 - Bin 9 phase	03 / 04	0.001°	0856	2	B856	2
47th Harmonic Component - Magnitude	03 / 04	0.001% / mV / mA	0858	2	B858	2
47th Harmonic Component - Phase	03 / 04	0.001°	085A	2	B85A	2
Interharmonic Group 47 - Bin 1 magnitude	03 / 04	0.001% / mV / mA	085C	2	B85C	2
Interharmonic Group 47 - Bin 1 phase	03 / 04	0.001°	085E	2	B85E	2
Interharmonic Group 47 - Bin 2 magnitude	03 / 04	0.001% / mV / mA	0860	2	B860	2
Interharmonic Group 47 - Bin 2 phase	03 / 04	0.001°	0862	2	B862	2
Interharmonic Group 47 - Bin 3 magnitude	03 / 04	0.001% / mV / mA	0864	2	B864	2
Interharmonic Group 47 - Bin 3 phase	03 / 04	0.001°	0866	2	B866	2
Interharmonic Group 47 - Bin 4 magnitude	03 / 04	0.001% / mV / mA	0868	2	B868	2
Interharmonic Group 47 - Bin 4 phase	03 / 04	0.001°	086A	2	B86A	2
Interharmonic Group 47 - Bin 5 magnitude	03 / 04	0.001% / mV / mA	086C	2	B86C	2
Interharmonic Group 47 - Bin 5 phase	03 / 04	0.001°	086E	2	B86E	2
Interharmonic Group 47 - Bin 6 magnitude	03 / 04	0.001% / mV / mA	0870	2	B870	2
Interharmonic Group 47 - Bin 6 phase	03 / 04	0.001°	0872	2	B872	2
Interharmonic Group 47 - Bin 7 magnitude	03 / 04	0.001% / mV / mA	0874	2	B874	2
Interharmonic Group 47 - Bin 7 phase	03 / 04	0.001°	0876	2	B876	2
Interharmonic Group 47 - Bin 8 magnitude	03 / 04	0.001% / mV / mA	0878	2	B878	2
Interharmonic Group 47 - Bin 8 phase	03 / 04	0.001°	087A	2	B87A	2
Interharmonic Group 47 - Bin 9 magnitude	03 / 04	0.001% / mV / mA	087C	2	B87C	2
Interharmonic Group 47 - Bin 9 phase	03 / 04	0.001°	087E	2	B87E	2
48th Harmonic Component - Magnitude	03 / 04	0.001% / mV / mA	0880	2	B880	2
48th Harmonic Component - Phase	03 / 04	0.001°	0882	2	B882	2
Interharmonic Group 48 - Bin 1 magnitude	03 / 04	0.001% / mV / mA	0884	2	B884	2
Interharmonic Group 48 - Bin 1 phase	03 / 04	0.001°	0886	2	B886	2

Parameter	F. code (Hex)	M.U.	INTEGER		IEEE	
			Register (Hex)	Words	Register (Hex)	Words
VOLTAGE & CURRENT HARMONICS & INTERHARMONICS MAGNITUDE&PHASE - fnom=50 Hz						
Interharmonic Group 48 - Bin 2 magnitude	03 / 04	0.001% / mV / mA	0888	2	B888	2
Interharmonic Group 48 - Bin 2 phase	03 / 04	0.001°	088A	2	B88A	2
Interharmonic Group 48 - Bin 3 magnitude	03 / 04	0.001% / mV / mA	088C	2	B88C	2
Interharmonic Group 48 - Bin 3 phase	03 / 04	0.001°	088E	2	B88E	2
Interharmonic Group 48 - Bin 4 magnitude	03 / 04	0.001% / mV / mA	0890	2	B890	2
Interharmonic Group 48 - Bin 4 phase	03 / 04	0.001°	0892	2	B892	2
Interharmonic Group 48 - Bin 5 magnitude	03 / 04	0.001% / mV / mA	0894	2	B894	2
Interharmonic Group 48 - Bin 5 phase	03 / 04	0.001°	0896	2	B896	2
Interharmonic Group 48 - Bin 6 magnitude	03 / 04	0.001% / mV / mA	0898	2	B898	2
Interharmonic Group 48 - Bin 6 phase	03 / 04	0.001°	089A	2	B89A	2
Interharmonic Group 48 - Bin 7 magnitude	03 / 04	0.001% / mV / mA	089C	2	B89C	2
Interharmonic Group 48 - Bin 7 phase	03 / 04	0.001°	089E	2	B89E	2
Interharmonic Group 48 - Bin 8 magnitude	03 / 04	0.001% / mV / mA	08A0	2	B8A0	2
Interharmonic Group 48 - Bin 8 phase	03 / 04	0.001°	08A2	2	B8A2	2
Interharmonic Group 48 - Bin 9 magnitude	03 / 04	0.001% / mV / mA	08A4	2	B8A4	2
Interharmonic Group 48 - Bin 9 phase	03 / 04	0.001°	08A6	2	B8A6	2
49th Harmonic Component - Magnitude	03 / 04	0.001% / mV / mA	08A8	2	B8A8	2
49th Harmonic Component - Phase	03 / 04	0.001°	08AA	2	B8AA	2
Interharmonic Group 49 - Bin 1 magnitude	03 / 04	0.001% / mV / mA	08AC	2	B8AC	2
Interharmonic Group 49 - Bin 1 phase	03 / 04	0.001°	08AE	2	B8AE	2
Interharmonic Group 49 - Bin 2 magnitude	03 / 04	0.001% / mV / mA	08B0	2	B8B0	2
Interharmonic Group 49 - Bin 2 phase	03 / 04	0.001°	08B2	2	B8B2	2
Interharmonic Group 49 - Bin 3 magnitude	03 / 04	0.001% / mV / mA	08B4	2	B8B4	2
Interharmonic Group 49 - Bin 3 phase	03 / 04	0.001°	08B6	2	B8B6	2
Interharmonic Group 49 - Bin 4 magnitude	03 / 04	0.001% / mV / mA	08B8	2	B8B8	2
Interharmonic Group 49 - Bin 4 phase	03 / 04	0.001°	08BA	2	B8BA	2
Interharmonic Group 49 - Bin 5 magnitude	03 / 04	0.001% / mV / mA	08BC	2	B8BC	2
Interharmonic Group 49 - Bin 5 phase	03 / 04	0.001°	08BE	2	B8BE	2
Interharmonic Group 49 - Bin 6 magnitude	03 / 04	0.001% / mV / mA	08C0	2	B8C0	2
Interharmonic Group 49 - Bin 6 phase	03 / 04	0.001°	08C2	2	B8C2	2
Interharmonic Group 49 - Bin 7 magnitude	03 / 04	0.001% / mV / mA	08C4	2	B8C4	2
Interharmonic Group 49 - Bin 7 phase	03 / 04	0.001°	08C6	2	B8C6	2
Interharmonic Group 49 - Bin 8 magnitude	03 / 04	0.001% / mV / mA	08C8	2	B8C8	2
Interharmonic Group 49 - Bin 8 phase	03 / 04	0.001°	08CA	2	B8CA	2
Interharmonic Group 49 - Bin 9 magnitude	03 / 04	0.001% / mV / mA	08CC	2	B8CC	2
Interharmonic Group 49 - Bin 9 phase	03 / 04	0.001°	08CE	2	B8CE	2
50th Harmonic Component - Magnitude	03 / 04	0.001% / mV / mA	08D0	2	B8D0	2
50th Harmonic Component - Phase	03 / 04	0.001°	08D2	2	B8D2	2
Interharmonic Group 50 - Bin 1 magnitude	03 / 04	0.001% / mV / mA	08D4	2	B8D4	2
Interharmonic Group 50 - Bin 1 phase	03 / 04	0.001°	08D6	2	B8D6	2
Interharmonic Group 50 - Bin 2 magnitude	03 / 04	0.001% / mV / mA	08D8	2	B8D8	2
Interharmonic Group 50 - Bin 2 phase	03 / 04	0.001°	08DA	2	B8DA	2
Interharmonic Group 50 - Bin 3 magnitude	03 / 04	0.001% / mV / mA	08DC	2	B8DC	2
Interharmonic Group 50 - Bin 3 phase	03 / 04	0.001°	08DE	2	B8DE	2
Interharmonic Group 50 - Bin 4 magnitude	03 / 04	0.001% / mV / mA	08E0	2	B8E0	2
Interharmonic Group 50 - Bin 4 phase	03 / 04	0.001°	08E2	2	B8E2	2
Interharmonic Group 50 - Bin 5 magnitude	03 / 04	0.001% / mV / mA	08E4	2	B8E4	2
Interharmonic Group 50 - Bin 5 phase	03 / 04	0.001°	08E6	2	B8E6	2
Interharmonic Group 50 - Bin 6 magnitude	03 / 04	0.001% / mV / mA	08E8	2	B8E8	2
Interharmonic Group 50 - Bin 6 phase	03 / 04	0.001°	08EA	2	B8EA	2

Parameter	F. code (Hex)	M.U.	INTEGER		IEEE	
			Register (Hex)	Words	Register (Hex)	Words
VOLTAGE & CURRENT HARMONICS & INTERHARMONICS MAGNITUDE&PHASE - fnom=50 Hz						
Interharmonic Group 50 - Bin 7 magnitude	03 / 04	0.001% / mV / mA	08EC	2	B8EC	2
Interharmonic Group 50 - Bin 7 phase	03 / 04	0.001°	08EE	2	B8EE	2
Interharmonic Group 50 - Bin 8 magnitude	03 / 04	0.001% / mV / mA	08F0	2	B8F0	2
Interharmonic Group 50 - Bin 8 phase	03 / 04	0.001°	08F2	2	B8F2	2
Interharmonic Group 50 - Bin 9 magnitude	03 / 04	0.001% / mV / mA	08F4	2	B8F4	2
Interharmonic Group 50 - Bin 9 phase	03 / 04	0.001°	08F6	2	B8F6	2
51st Harmonic Component - Magnitude	03 / 04	0.001% / mV / mA	08F8	2	B8F8	2
51st Harmonic Component - Phase	03 / 04	0.001°	08FA	2	B8FA	2
Interharmonic Group 51 - Bin 1 magnitude	03 / 04	0.001% / mV / mA	08FC	2	B8FC	2
Interharmonic Group 51 - Bin 1 phase	03 / 04	0.001°	08FE	2	B8FE	2
Interharmonic Group 51 - Bin 2 magnitude	03 / 04	0.001% / mV / mA	0900	2	B900	2
Interharmonic Group 51 - Bin 2 phase	03 / 04	0.001°	0902	2	B902	2
Interharmonic Group 51 - Bin 3 magnitude	03 / 04	0.001% / mV / mA	0904	2	B904	2
Interharmonic Group 51 - Bin 3 phase	03 / 04	0.001°	0906	2	B906	2
Interharmonic Group 51 - Bin 4 magnitude	03 / 04	0.001% / mV / mA	0908	2	B908	2
Interharmonic Group 51 - Bin 4 phase	03 / 04	0.001°	090A	2	B90A	2
Interharmonic Group 51 - Bin 5 magnitude	03 / 04	0.001% / mV / mA	090C	2	B90C	2
Interharmonic Group 51 - Bin 5 phase	03 / 04	0.001°	090E	2	B90E	2
Interharmonic Group 51 - Bin 6 magnitude	03 / 04	0.001% / mV / mA	0910	2	B910	2
Interharmonic Group 51 - Bin 6 phase	03 / 04	0.001°	0912	2	B912	2
Interharmonic Group 51 - Bin 7 magnitude	03 / 04	0.001% / mV / mA	0914	2	B914	2
Interharmonic Group 51 - Bin 7 phase	03 / 04	0.001°	0916	2	B916	2
Interharmonic Group 51 - Bin 8 magnitude	03 / 04	0.001% / mV / mA	0918	2	B918	2
Interharmonic Group 51 - Bin 8 phase	03 / 04	0.001°	091A	2	B91A	2
Interharmonic Group 51 - Bin 9 magnitude	03 / 04	0.001% / mV / mA	091C	2	B91C	2
Interharmonic Group 51 - Bin 9 phase	03 / 04	0.001°	091E	2	B91E	2
52nd Harmonic Component - Magnitude	03 / 04	0.001% / mV / mA	0920	2	B920	2
52nd Harmonic Component - Phase	03 / 04	0.001°	0922	2	B922	2
Interharmonic Group 52 - Bin 1 magnitude	03 / 04	0.001% / mV / mA	0924	2	B924	2
Interharmonic Group 52 - Bin 1 phase	03 / 04	0.001°	0926	2	B926	2
Interharmonic Group 52 - Bin 2 magnitude	03 / 04	0.001% / mV / mA	0928	2	B928	2
Interharmonic Group 52 - Bin 2 phase	03 / 04	0.001°	092A	2	B92A	2
Interharmonic Group 52 - Bin 3 magnitude	03 / 04	0.001% / mV / mA	092C	2	B92C	2
Interharmonic Group 52 - Bin 3 phase	03 / 04	0.001°	092E	2	B92E	2
Interharmonic Group 52 - Bin 4 magnitude	03 / 04	0.001% / mV / mA	0930	2	B930	2
Interharmonic Group 52 - Bin 4 phase	03 / 04	0.001°	0932	2	B932	2
Interharmonic Group 52 - Bin 5 magnitude	03 / 04	0.001% / mV / mA	0934	2	B934	2
Interharmonic Group 52 - Bin 5 phase	03 / 04	0.001°	0936	2	B936	2
Interharmonic Group 52 - Bin 6 magnitude	03 / 04	0.001% / mV / mA	0938	2	B938	2
Interharmonic Group 52 - Bin 6 phase	03 / 04	0.001°	093A	2	B93A	2
Interharmonic Group 52 - Bin 7 magnitude	03 / 04	0.001% / mV / mA	093C	2	B93C	2
Interharmonic Group 52 - Bin 7 phase	03 / 04	0.001°	093E	2	B93E	2
Interharmonic Group 52 - Bin 8 magnitude	03 / 04	0.001% / mV / mA	0940	2	B940	2
Interharmonic Group 52 - Bin 8 phase	03 / 04	0.001°	0942	2	B942	2
Interharmonic Group 52 - Bin 9 magnitude	03 / 04	0.001% / mV / mA	0944	2	B944	2
Interharmonic Group 52 - Bin 9 phase	03 / 04	0.001°	0946	2	B946	2
53rd Harmonic Component - Magnitude	03 / 04	0.001% / mV / mA	0948	2	B948	2
53rd Harmonic Component - Phase	03 / 04	0.001°	094A	2	B94A	2
Interharmonic Group 53 - Bin 1 magnitude	03 / 04	0.001% / mV / mA	094C	2	B94C	2
Interharmonic Group 53 - Bin 1 phase	03 / 04	0.001°	094E	2	B94E	2

Parameter	F. code (Hex)	M.U.	INTEGER		IEEE	
			Register (Hex)	Words	Register (Hex)	Words
VOLTAGE & CURRENT HARMONICS & INTERHARMONICS MAGNITUDE&PHASE - fnom=50 Hz						
Interharmonic Group 53 - Bin 2 magnitude	03 / 04	0.001% / mV / mA	0950	2	B950	2
Interharmonic Group 53 - Bin 2 phase	03 / 04	0.001°	0952	2	B952	2
Interharmonic Group 53 - Bin 3 magnitude	03 / 04	0.001% / mV / mA	0954	2	B954	2
Interharmonic Group 53 - Bin 3 phase	03 / 04	0.001°	0956	2	B956	2
Interharmonic Group 53 - Bin 4 magnitude	03 / 04	0.001% / mV / mA	0958	2	B958	2
Interharmonic Group 53 - Bin 4 phase	03 / 04	0.001°	095A	2	B95A	2
Interharmonic Group 53 - Bin 5 magnitude	03 / 04	0.001% / mV / mA	095C	2	B95C	2
Interharmonic Group 53 - Bin 5 phase	03 / 04	0.001°	095E	2	B95E	2
Interharmonic Group 53 - Bin 6 magnitude	03 / 04	0.001% / mV / mA	0960	2	B960	2
Interharmonic Group 53 - Bin 6 phase	03 / 04	0.001°	0962	2	B962	2
Interharmonic Group 53 - Bin 7 magnitude	03 / 04	0.001% / mV / mA	0964	2	B964	2
Interharmonic Group 53 - Bin 7 phase	03 / 04	0.001°	0966	2	B966	2
Interharmonic Group 53 - Bin 8 magnitude	03 / 04	0.001% / mV / mA	0968	2	B968	2
Interharmonic Group 53 - Bin 8 phase	03 / 04	0.001°	096A	2	B96A	2
Interharmonic Group 53 - Bin 9 magnitude	03 / 04	0.001% / mV / mA	096C	2	B96C	2
Interharmonic Group 53 - Bin 9 phase	03 / 04	0.001°	096E	2	B96E	2
54th Harmonic Component - Magnitude	03 / 04	0.001% / mV / mA	0970	2	B970	2
54th Harmonic Component - Phase	03 / 04	0.001°	0972	2	B972	2
Interharmonic Group 54 - Bin 1 magnitude	03 / 04	0.001% / mV / mA	0974	2	B974	2
Interharmonic Group 54 - Bin 1 phase	03 / 04	0.001°	0976	2	B976	2
Interharmonic Group 54 - Bin 2 magnitude	03 / 04	0.001% / mV / mA	0978	2	B978	2
Interharmonic Group 54 - Bin 2 phase	03 / 04	0.001°	097A	2	B97A	2
Interharmonic Group 54 - Bin 3 magnitude	03 / 04	0.001% / mV / mA	097C	2	B97C	2
Interharmonic Group 54 - Bin 3 phase	03 / 04	0.001°	097E	2	B97E	2
Interharmonic Group 54 - Bin 4 magnitude	03 / 04	0.001% / mV / mA	0980	2	B980	2
Interharmonic Group 54 - Bin 4 phase	03 / 04	0.001°	0982	2	B982	2
Interharmonic Group 54 - Bin 5 magnitude	03 / 04	0.001% / mV / mA	0984	2	B984	2
Interharmonic Group 54 - Bin 5 phase	03 / 04	0.001°	0986	2	B986	2
Interharmonic Group 54 - Bin 6 magnitude	03 / 04	0.001% / mV / mA	0988	2	B988	2
Interharmonic Group 54 - Bin 6 phase	03 / 04	0.001°	098A	2	B98A	2
Interharmonic Group 54 - Bin 7 magnitude	03 / 04	0.001% / mV / mA	098C	2	B98C	2
Interharmonic Group 54 - Bin 7 phase	03 / 04	0.001°	098E	2	B98E	2
Interharmonic Group 54 - Bin 8 magnitude	03 / 04	0.001% / mV / mA	0990	2	B990	2
Interharmonic Group 54 - Bin 8 phase	03 / 04	0.001°	0992	2	B992	2
Interharmonic Group 54 - Bin 9 magnitude	03 / 04	0.001% / mV / mA	0994	2	B994	2
Interharmonic Group 54 - Bin 9 phase	03 / 04	0.001°	0996	2	B996	2
55th Harmonic Component - Magnitude	03 / 04	0.001% / mV / mA	0998	2	B998	2
55th Harmonic Component - Phase	03 / 04	0.001°	099A	2	B99A	2
Interharmonic Group 55 - Bin 1 magnitude	03 / 04	0.001% / mV / mA	099C	2	B99C	2
Interharmonic Group 55 - Bin 1 phase	03 / 04	0.001°	099E	2	B99E	2
Interharmonic Group 55 - Bin 2 magnitude	03 / 04	0.001% / mV / mA	09A0	2	B9A0	2
Interharmonic Group 55 - Bin 2 phase	03 / 04	0.001°	09A2	2	B9A2	2
Interharmonic Group 55 - Bin 3 magnitude	03 / 04	0.001% / mV / mA	09A4	2	B9A4	2
Interharmonic Group 55 - Bin 3 phase	03 / 04	0.001°	09A6	2	B9A6	2
Interharmonic Group 55 - Bin 4 magnitude	03 / 04	0.001% / mV / mA	09A8	2	B9A8	2
Interharmonic Group 55 - Bin 4 phase	03 / 04	0.001°	09AA	2	B9AA	2
Interharmonic Group 55 - Bin 5 magnitude	03 / 04	0.001% / mV / mA	09AC	2	B9AC	2
Interharmonic Group 55 - Bin 5 phase	03 / 04	0.001°	09AE	2	B9AE	2
Interharmonic Group 55 - Bin 6 magnitude	03 / 04	0.001% / mV / mA	09B0	2	B9B0	2
Interharmonic Group 55 - Bin 6 phase	03 / 04	0.001°	09B2	2	B9B2	2

Parameter	F. code (Hex)	M.U.	INTEGER		IEEE	
			Register (Hex)	Words	Register (Hex)	Words
VOLTAGE & CURRENT HARMONICS & INTERHARMONICS MAGNITUDE&PHASE - f_{nom}=50 Hz						
Interharmonic Group 55 - Bin 7 magnitude	03 / 04	0.001% / mV / mA	09B4	2	B9B4	2
Interharmonic Group 55 - Bin 7 phase	03 / 04	0.001°	09B6	2	B9B6	2
Interharmonic Group 55 - Bin 8 magnitude	03 / 04	0.001% / mV / mA	09B8	2	B9B8	2
Interharmonic Group 55 - Bin 8 phase	03 / 04	0.001°	09BA	2	B9BA	2
Interharmonic Group 55 - Bin 9 magnitude	03 / 04	0.001% / mV / mA	09BC	2	B9BC	2
Interharmonic Group 55 - Bin 9 phase	03 / 04	0.001°	09BE	2	B9BE	2
56th Harmonic Component - Magnitude	03 / 04	0.001% / mV / mA	09C0	2	B9C0	2
56th Harmonic Component - Phase	03 / 04	0.001°	09C2	2	B9C2	2
Interharmonic Group 56 - Bin 1 magnitude	03 / 04	0.001% / mV / mA	09C4	2	B9C4	2
Interharmonic Group 56 - Bin 1 phase	03 / 04	0.001°	09C6	2	B9C6	2
Interharmonic Group 56 - Bin 2 magnitude	03 / 04	0.001% / mV / mA	09C8	2	B9C8	2
Interharmonic Group 56 - Bin 2 phase	03 / 04	0.001°	09CA	2	B9CA	2
Interharmonic Group 56 - Bin 3 magnitude	03 / 04	0.001% / mV / mA	09CC	2	B9CC	2
Interharmonic Group 56 - Bin 3 phase	03 / 04	0.001°	09CE	2	B9CE	2
Interharmonic Group 56 - Bin 4 magnitude	03 / 04	0.001% / mV / mA	09D0	2	B9D0	2
Interharmonic Group 56 - Bin 4 phase	03 / 04	0.001°	09D2	2	B9D2	2
Interharmonic Group 56 - Bin 5 magnitude	03 / 04	0.001% / mV / mA	09D4	2	B9D4	2
Interharmonic Group 56 - Bin 5 phase	03 / 04	0.001°	09D6	2	B9D6	2
Interharmonic Group 56 - Bin 6 magnitude	03 / 04	0.001% / mV / mA	09D8	2	B9D8	2
Interharmonic Group 56 - Bin 6 phase	03 / 04	0.001°	09DA	2	B9DA	2
Interharmonic Group 56 - Bin 7 magnitude	03 / 04	0.001% / mV / mA	09DC	2	B9DC	2
Interharmonic Group 56 - Bin 7 phase	03 / 04	0.001°	09DE	2	B9DE	2
Interharmonic Group 56 - Bin 8 magnitude	03 / 04	0.001% / mV / mA	09E0	2	B9E0	2
Interharmonic Group 56 - Bin 8 phase	03 / 04	0.001°	09E2	2	B9E2	2
Interharmonic Group 56 - Bin 9 magnitude	03 / 04	0.001% / mV / mA	09E4	2	B9E4	2
Interharmonic Group 56 - Bin 9 phase	03 / 04	0.001°	09E6	2	B9E6	2
57th Harmonic Component - Magnitude	03 / 04	0.001% / mV / mA	09E8	2	B9E8	2
57th Harmonic Component - Phase	03 / 04	0.001°	09EA	2	B9EA	2
Interharmonic Group 57 - Bin 1 magnitude	03 / 04	0.001% / mV / mA	09EC	2	B9EC	2
Interharmonic Group 57 - Bin 1 phase	03 / 04	0.001°	09EE	2	B9EE	2
Interharmonic Group 57 - Bin 2 magnitude	03 / 04	0.001% / mV / mA	09F0	2	B9F0	2
Interharmonic Group 57 - Bin 2 phase	03 / 04	0.001°	09F2	2	B9F2	2
Interharmonic Group 57 - Bin 3 magnitude	03 / 04	0.001% / mV / mA	09F4	2	B9F4	2
Interharmonic Group 57 - Bin 3 phase	03 / 04	0.001°	09F6	2	B9F6	2
Interharmonic Group 57 - Bin 4 magnitude	03 / 04	0.001% / mV / mA	09F8	2	B9F8	2
Interharmonic Group 57 - Bin 4 phase	03 / 04	0.001°	09FA	2	B9FA	2
Interharmonic Group 57 - Bin 5 magnitude	03 / 04	0.001% / mV / mA	09FC	2	B9FC	2
Interharmonic Group 57 - Bin 5 phase	03 / 04	0.001°	09FE	2	B9FE	2
Interharmonic Group 57 - Bin 6 magnitude	03 / 04	0.001% / mV / mA	0A00	2	BA00	2
Interharmonic Group 57 - Bin 6 phase	03 / 04	0.001°	0A02	2	BA02	2
Interharmonic Group 57 - Bin 7 magnitude	03 / 04	0.001% / mV / mA	0A04	2	BA04	2
Interharmonic Group 57 - Bin 7 phase	03 / 04	0.001°	0A06	2	BA06	2
Interharmonic Group 57 - Bin 8 magnitude	03 / 04	0.001% / mV / mA	0A08	2	BA08	2
Interharmonic Group 57 - Bin 8 phase	03 / 04	0.001°	0A0A	2	BA0A	2
Interharmonic Group 57 - Bin 9 magnitude	03 / 04	0.001% / mV / mA	0A0C	2	BA0C	2
Interharmonic Group 57 - Bin 9 phase	03 / 04	0.001°	0A0E	2	BA0E	2
58th Harmonic Component - Magnitude	03 / 04	0.001% / mV / mA	0A10	2	BA10	2
58th Harmonic Component - Phase	03 / 04	0.001°	0A12	2	BA12	2
Interharmonic Group 58 - Bin 1 magnitude	03 / 04	0.001% / mV / mA	0A14	2	BA14	2
Interharmonic Group 58 - Bin 1 phase	03 / 04	0.001°	0A16	2	BA16	2

Parameter	F. code (Hex)	M.U.	INTEGER		IEEE	
			Register (Hex)	Words	Register (Hex)	Words
VOLTAGE & CURRENT HARMONICS & INTERHARMONICS MAGNITUDE&PHASE - f_{nom}=50 Hz						
Interharmonic Group 58 - Bin 2 magnitude	03 / 04	0.001% / mV / mA	0A18	2	BA18	2
Interharmonic Group 58 - Bin 2 phase	03 / 04	0.001°	0A1A	2	BA1A	2
Interharmonic Group 58 - Bin 3 magnitude	03 / 04	0.001% / mV / mA	0A1C	2	BA1C	2
Interharmonic Group 58 - Bin 3 phase	03 / 04	0.001°	0A1E	2	BA1E	2
Interharmonic Group 58 - Bin 4 magnitude	03 / 04	0.001% / mV / mA	0A20	2	BA20	2
Interharmonic Group 58 - Bin 4 phase	03 / 04	0.001°	0A22	2	BA22	2
Interharmonic Group 58 - Bin 5 magnitude	03 / 04	0.001% / mV / mA	0A24	2	BA24	2
Interharmonic Group 58 - Bin 5 phase	03 / 04	0.001°	0A26	2	BA26	2
Interharmonic Group 58 - Bin 6 magnitude	03 / 04	0.001% / mV / mA	0A28	2	BA28	2
Interharmonic Group 58 - Bin 6 phase	03 / 04	0.001°	0A2A	2	BA2A	2
Interharmonic Group 58 - Bin 7 magnitude	03 / 04	0.001% / mV / mA	0A2C	2	BA2C	2
Interharmonic Group 58 - Bin 7 phase	03 / 04	0.001°	0A2E	2	BA2E	2
Interharmonic Group 58 - Bin 8 magnitude	03 / 04	0.001% / mV / mA	0A30	2	BA30	2
Interharmonic Group 58 - Bin 8 phase	03 / 04	0.001°	0A32	2	BA32	2
Interharmonic Group 58 - Bin 9 magnitude	03 / 04	0.001% / mV / mA	0A34	2	BA34	2
Interharmonic Group 58 - Bin 9 phase	03 / 04	0.001°	0A36	2	BA36	2
59th Harmonic Component - Magnitude	03 / 04	0.001% / mV / mA	0A38	2	BA38	2
59th Harmonic Component - Phase	03 / 04	0.001°	0A3A	2	BA3A	2
Interharmonic Group 59 - Bin 1 magnitude	03 / 04	0.001% / mV / mA	0A3C	2	BA3C	2
Interharmonic Group 59 - Bin 1 phase	03 / 04	0.001°	0A3E	2	BA3E	2
Interharmonic Group 59 - Bin 2 magnitude	03 / 04	0.001% / mV / mA	0A40	2	BA40	2
Interharmonic Group 59 - Bin 2 phase	03 / 04	0.001°	0A42	2	BA42	2
Interharmonic Group 59 - Bin 3 magnitude	03 / 04	0.001% / mV / mA	0A44	2	BA44	2
Interharmonic Group 59 - Bin 3 phase	03 / 04	0.001°	0A46	2	BA46	2
Interharmonic Group 59 - Bin 4 magnitude	03 / 04	0.001% / mV / mA	0A48	2	BA48	2
Interharmonic Group 59 - Bin 4 phase	03 / 04	0.001°	0A4A	2	BA4A	2
Interharmonic Group 59 - Bin 5 magnitude	03 / 04	0.001% / mV / mA	0A4C	2	BA4C	2
Interharmonic Group 59 - Bin 5 phase	03 / 04	0.001°	0A4E	2	BA4E	2
Interharmonic Group 59 - Bin 6 magnitude	03 / 04	0.001% / mV / mA	0A50	2	BA50	2
Interharmonic Group 59 - Bin 6 phase	03 / 04	0.001°	0A52	2	BA52	2
Interharmonic Group 59 - Bin 7 magnitude	03 / 04	0.001% / mV / mA	0A54	2	BA54	2
Interharmonic Group 59 - Bin 7 phase	03 / 04	0.001°	0A56	2	BA56	2
Interharmonic Group 59 - Bin 8 magnitude	03 / 04	0.001% / mV / mA	0A58	2	BA58	2
Interharmonic Group 59 - Bin 8 phase	03 / 04	0.001°	0A5A	2	BA5A	2
Interharmonic Group 59 - Bin 9 magnitude	03 / 04	0.001% / mV / mA	0A5C	2	BA5C	2
Interharmonic Group 59 - Bin 9 phase	03 / 04	0.001°	0A5E	2	BA5E	2
60th Harmonic Component - Magnitude	03 / 04	0.001% / mV / mA	0A60	2	BA60	2
60th Harmonic Component - Phase	03 / 04	0.001°	0A62	2	BA62	2
Interharmonic Group 60 - Bin 1 magnitude	03 / 04	0.001% / mV / mA	0A64	2	BA64	2
Interharmonic Group 60 - Bin 1 phase	03 / 04	0.001°	0A66	2	BA66	2
Interharmonic Group 60 - Bin 2 magnitude	03 / 04	0.001% / mV / mA	0A68	2	BA68	2
Interharmonic Group 60 - Bin 2 phase	03 / 04	0.001°	0A6A	2	BA6A	2
Interharmonic Group 60 - Bin 3 magnitude	03 / 04	0.001% / mV / mA	0A6C	2	BA6C	2
Interharmonic Group 60 - Bin 3 phase	03 / 04	0.001°	0A6E	2	BA6E	2
Interharmonic Group 60 - Bin 4 magnitude	03 / 04	0.001% / mV / mA	0A70	2	BA70	2
Interharmonic Group 60 - Bin 4 phase	03 / 04	0.001°	0A72	2	BA72	2
Interharmonic Group 60 - Bin 5 magnitude	03 / 04	0.001% / mV / mA	0A74	2	BA74	2
Interharmonic Group 60 - Bin 5 phase	03 / 04	0.001°	0A76	2	BA76	2
Interharmonic Group 60 - Bin 6 magnitude	03 / 04	0.001% / mV / mA	0A78	2	BA78	2
Interharmonic Group 60 - Bin 6 phase	03 / 04	0.001°	0A7A	2	BA7A	2

Parameter	F. code (Hex)	M.U.	INTEGER		IEEE	
			Register (Hex)	Words	Register (Hex)	Words
VOLTAGE & CURRENT HARMONICS & INTERHARMONICS MAGNITUDE&PHASE - fnom=50 Hz						
Interharmonic Group 60 - Bin 7 magnitude	03 / 04	0.001% / mV / mA	0A7C	2	BA7C	2
Interharmonic Group 60 - Bin 7 phase	03 / 04	0.001°	0A7E	2	BA7E	2
Interharmonic Group 60 - Bin 8 magnitude	03 / 04	0.001% / mV / mA	0A80	2	BA80	2
Interharmonic Group 60 - Bin 8 phase	03 / 04	0.001°	0A82	2	BA82	2
Interharmonic Group 60 - Bin 9 magnitude	03 / 04	0.001% / mV / mA	0A84	2	BA84	2
Interharmonic Group 60 - Bin 9 phase	03 / 04	0.001°	0A86	2	BA86	2
61st Harmonic Component - Magnitude	03 / 04	0.001% / mV / mA	0A88	2	BA88	2
61st Harmonic Component - Phase	03 / 04	0.001°	0A8A	2	BA8A	2
Interharmonic Group 61 - Bin 1 magnitude	03 / 04	0.001% / mV / mA	0A8C	2	BA8C	2
Interharmonic Group 61 - Bin 1 phase	03 / 04	0.001°	0A8E	2	BA8E	2
Interharmonic Group 61 - Bin 2 magnitude	03 / 04	0.001% / mV / mA	0A90	2	BA90	2
Interharmonic Group 61 - Bin 2 phase	03 / 04	0.001°	0A92	2	BA92	2
Interharmonic Group 61 - Bin 3 magnitude	03 / 04	0.001% / mV / mA	0A94	2	BA94	2
Interharmonic Group 61 - Bin 3 phase	03 / 04	0.001°	0A96	2	BA96	2
Interharmonic Group 61 - Bin 4 magnitude	03 / 04	0.001% / mV / mA	0A98	2	BA98	2
Interharmonic Group 61 - Bin 4 phase	03 / 04	0.001°	0A9A	2	BA9A	2
Interharmonic Group 61 - Bin 5 magnitude	03 / 04	0.001% / mV / mA	0A9C	2	BA9C	2
Interharmonic Group 61 - Bin 5 phase	03 / 04	0.001°	0A9E	2	BA9E	2
Interharmonic Group 61 - Bin 6 magnitude	03 / 04	0.001% / mV / mA	0AA0	2	BAA0	2
Interharmonic Group 61 - Bin 6 phase	03 / 04	0.001°	0AA2	2	BAA2	2
Interharmonic Group 61 - Bin 7 magnitude	03 / 04	0.001% / mV / mA	0AA4	2	BAA4	2
Interharmonic Group 61 - Bin 7 phase	03 / 04	0.001°	0AA6	2	BAA6	2
Interharmonic Group 61 - Bin 8 magnitude	03 / 04	0.001% / mV / mA	0AA8	2	BAA8	2
Interharmonic Group 61 - Bin 8 phase	03 / 04	0.001°	0AAA	2	BAAA	2
Interharmonic Group 61 - Bin 9 magnitude	03 / 04	0.001% / mV / mA	0AAC	2	BAAC	2
Interharmonic Group 61 - Bin 9 phase	03 / 04	0.001°	0AAE	2	BAAE	2
62nd Harmonic Component - Magnitude	03 / 04	0.001% / mV / mA	0AB0	2	BAB0	2
62nd Harmonic Component - Phase	03 / 04	0.001°	0AB2	2	BAB2	2
Interharmonic Group 62 - Bin 1 magnitude	03 / 04	0.001% / mV / mA	0AB4	2	BAB4	2
Interharmonic Group 62 - Bin 1 phase	03 / 04	0.001°	0AB6	2	BAB6	2
Interharmonic Group 62 - Bin 2 magnitude	03 / 04	0.001% / mV / mA	0AB8	2	BAB8	2
Interharmonic Group 62 - Bin 2 phase	03 / 04	0.001°	0ABA	2	BABA	2
Interharmonic Group 62 - Bin 3 magnitude	03 / 04	0.001% / mV / mA	0ABC	2	BABC	2
Interharmonic Group 62 - Bin 3 phase	03 / 04	0.001°	0ABE	2	BABE	2
Interharmonic Group 62 - Bin 4 magnitude	03 / 04	0.001% / mV / mA	0AC0	2	BAC0	2
Interharmonic Group 62 - Bin 4 phase	03 / 04	0.001°	0AC2	2	BAC2	2
Interharmonic Group 62 - Bin 5 magnitude	03 / 04	0.001% / mV / mA	0AC4	2	BAC4	2
Interharmonic Group 62 - Bin 5 phase	03 / 04	0.001°	0AC6	2	BAC6	2
Interharmonic Group 62 - Bin 6 magnitude	03 / 04	0.001% / mV / mA	0AC8	2	BAC8	2
Interharmonic Group 62 - Bin 6 phase	03 / 04	0.001°	0ACA	2	BACA	2
Interharmonic Group 62 - Bin 7 magnitude	03 / 04	0.001% / mV / mA	0ACC	2	BACC	2
Interharmonic Group 62 - Bin 7 phase	03 / 04	0.001°	0ACE	2	BACE	2
Interharmonic Group 62 - Bin 8 magnitude	03 / 04	0.001% / mV / mA	0AD0	2	BAD0	2
Interharmonic Group 62 - Bin 8 phase	03 / 04	0.001°	0AD2	2	BAD2	2
Interharmonic Group 62 - Bin 9 magnitude	03 / 04	0.001% / mV / mA	0AD4	2	BAD4	2
Interharmonic Group 62 - Bin 9 phase	03 / 04	0.001°	0AD6	2	BAD6	2
63rd Harmonic Component - Magnitude	03 / 04	0.001% / mV / mA	0AD8	2	BAD8	2
63rd Harmonic Component - Phase	03 / 04	0.001°	0ADA	2	BADA	2
Interharmonic Group 63 - Bin 1 magnitude	03 / 04	0.001% / mV / mA	0ADC	2	BADC	2
Interharmonic Group 63 - Bin 1 phase	03 / 04	0.001°	0ADE	2	BADE	2

Parameter	F. code (Hex)	M.U.	INTEGER		IEEE	
			Register (Hex)	Words	Register (Hex)	Words
VOLTAGE & CURRENT HARMONICS & INTERHARMONICS MAGNITUDE&PHASE - fnom=50 Hz						
Interharmonic Group 63 - Bin 2 magnitude	03 / 04	0.001% / mV / mA	0AE0	2	BAE0	2
Interharmonic Group 63 - Bin 2 phase	03 / 04	0.001°	0AE2	2	BAE2	2
Interharmonic Group 63 - Bin 3 magnitude	03 / 04	0.001% / mV / mA	0AE4	2	BAE4	2
Interharmonic Group 63 - Bin 3 phase	03 / 04	0.001°	0AE6	2	BAE6	2
Interharmonic Group 63 - Bin 4 magnitude	03 / 04	0.001% / mV / mA	0AE8	2	BAE8	2
Interharmonic Group 63 - Bin 4 phase	03 / 04	0.001°	0AEA	2	BAEA	2
Interharmonic Group 63 - Bin 5 magnitude	03 / 04	0.001% / mV / mA	0AEC	2	BAEC	2
Interharmonic Group 63 - Bin 5 phase	03 / 04	0.001°	0AEE	2	BAEE	2
Interharmonic Group 63 - Bin 6 magnitude	03 / 04	0.001% / mV / mA	0AF0	2	BAF0	2
Interharmonic Group 63 - Bin 6 phase	03 / 04	0.001°	0AF2	2	BAF2	2
Interharmonic Group 63 - Bin 7 magnitude	03 / 04	0.001% / mV / mA	0AF4	2	BAF4	2
Interharmonic Group 63 - Bin 7 phase	03 / 04	0.001°	0AF6	2	BAF6	2
Interharmonic Group 63 - Bin 8 magnitude	03 / 04	0.001% / mV / mA	0AF8	2	BAF8	2
Interharmonic Group 63 - Bin 8 phase	03 / 04	0.001°	0AFA	2	BAFA	2
Interharmonic Group 63 - Bin 9 magnitude	03 / 04	0.001% / mV / mA	0AFC	2	BAFC	2
Interharmonic Group 63 - Bin 9 phase	03 / 04	0.001°	0AFE	2	BAFE	2

Parameter	F. code (Hex)	M.U.	INTEGER		IEEE	
			Register (Hex)	Words	Register (Hex)	Words

VOLTAGE & CURRENT HARMONICS & INTERHARMONICS MAGNITUDE&PHASE - fnom=60 Hz

Set the parameter for the next reading command. Programmable data: \$01=Phase 1 to Neutral Voltage (U1N) \$02=Phase 2 to Neutral Voltage (U2N) \$03=Phase 3 to Neutral Voltage (U3N) \$04=Line 1 to 2 Voltage (U12) \$05=Line 2 to 3 Voltage (U23) \$06=Line 3 to 1 Voltage (U31) \$07=Phase 1 Current (I1) \$08=Phase 2 Current (I2) \$09=Phase 3 Current (I3)	10	-	0100	2	-	-
Example To read the Phase 1 current fundamental (1st) magnitude integer: 1. First send writing register 0100 by programming \$07 for parameter selection. 2. Then, send the reading register 0130.						
WARNING! The harmonic measuring unit changes according to the set display mode. If "Percentage" is set as display mode, the read harmonic magnitude will be in percentage values referred to the Fundamental. If "Absolute" is set as display mode, the read harmonic magnitude will be in absolute values (mV in case of voltage harmonics or mA in case of current harmonics).						
DC Component	03 / 04	0.001% / mV / mA	0102	2	B102	2
Interharmonic Group 0 - Bin 1 magnitude	03 / 04	0.001% / mV / mA	0104	2	B104	2
Interharmonic Group 0 - Bin 1 phase	03 / 04	0.001°	0106	2	B106	2
Interharmonic Group 0 - Bin 2 magnitude	03 / 04	0.001% / mV / mA	0108	2	B108	2
Interharmonic Group 0 - Bin 2 phase	03 / 04	0.001°	010A	2	B10A	2
Interharmonic Group 0 - Bin 3 magnitude	03 / 04	0.001% / mV / mA	010C	2	B10C	2
Interharmonic Group 0 - Bin 3 phase	03 / 04	0.001°	010E	2	B10E	2
Interharmonic Group 0 - Bin 4 magnitude	03 / 04	0.001% / mV / mA	0110	2	B110	2
Interharmonic Group 0 - Bin 4 phase	03 / 04	0.001°	0112	2	B112	2
Interharmonic Group 0 - Bin 5 magnitude	03 / 04	0.001% / mV / mA	0114	2	B114	2
Interharmonic Group 0 - Bin 5 phase	03 / 04	0.001°	0116	2	B116	2

Parameter	F. code (Hex)	M.U.	INTEGER		IEEE	
			Register (Hex)	Words	Register (Hex)	Words
VOLTAGE & CURRENT HARMONICS & INTERHARMONICS MAGNITUDE&PHASE - fnom=60 Hz						
Interharmonic Group 0 - Bin 6 magnitude	03 / 04	0.001% / mV / mA	0118	2	B118	2
Interharmonic Group 0 - Bin 6 phase	03 / 04	0.001°	011A	2	B11A	2
Interharmonic Group 0 - Bin 7 magnitude	03 / 04	0.001% / mV / mA	011C	2	B11C	2
Interharmonic Group 0 - Bin 7 phase	03 / 04	0.001°	011E	2	B11E	2
Interharmonic Group 0 - Bin 8 magnitude	03 / 04	0.001% / mV / mA	0120	2	B120	2
Interharmonic Group 0 - Bin 8 phase	03 / 04	0.001°	0122	2	B122	2
Interharmonic Group 0 - Bin 9 magnitude	03 / 04	0.001% / mV / mA	0124	2	B124	2
Interharmonic Group 0 - Bin 9 phase	03 / 04	0.001°	0126	2	B126	2
Interharmonic Group 0 - Bin 10 magnitude	03 / 04	0.001% / mV / mA	0128	2	B128	2
Interharmonic Group 0 - Bin 10 phase	03 / 04	0.001°	012A	2	B12A	2
Interharmonic Group 0 - Bin 11 magnitude	03 / 04	0.001% / mV / mA	012C	2	B12C	2
Interharmonic Group 0 - Bin 11 phase	03 / 04	0.001°	012E	2	B12E	2
1st Harmonic Component - Magnitude	03 / 04	0.001% / mV / mA	0130	2	B130	2
1st Harmonic Component - Phase	03 / 04	0.001°	0132	2	B132	2
Interharmonic Group 1 - Bin 1 magnitude	03 / 04	0.001% / mV / mA	0134	2	B134	2
Interharmonic Group 1 - Bin 1 phase	03 / 04	0.001°	0136	2	B136	2
Interharmonic Group 1 - Bin 2 magnitude	03 / 04	0.001% / mV / mA	0138	2	B138	2
Interharmonic Group 1 - Bin 2 phase	03 / 04	0.001°	013A	2	B13A	2
Interharmonic Group 1 - Bin 3 magnitude	03 / 04	0.001% / mV / mA	013C	2	B13C	2
Interharmonic Group 1 - Bin 3 phase	03 / 04	0.001°	013E	2	B13E	2
Interharmonic Group 1 - Bin 4 magnitude	03 / 04	0.001% / mV / mA	0140	2	B140	2
Interharmonic Group 1 - Bin 4 phase	03 / 04	0.001°	0142	2	B142	2
Interharmonic Group 1 - Bin 5 magnitude	03 / 04	0.001% / mV / mA	0144	2	B144	2
Interharmonic Group 1 - Bin 5 phase	03 / 04	0.001°	0146	2	B146	2
Interharmonic Group 1 - Bin 6 magnitude	03 / 04	0.001% / mV / mA	0148	2	B148	2
Interharmonic Group 1 - Bin 6 phase	03 / 04	0.001°	014A	2	B14A	2
Interharmonic Group 1 - Bin 7 magnitude	03 / 04	0.001% / mV / mA	014C	2	B14C	2
Interharmonic Group 1 - Bin 7 phase	03 / 04	0.001°	014E	2	B14E	2
Interharmonic Group 1 - Bin 8 magnitude	03 / 04	0.001% / mV / mA	0150	2	B150	2
Interharmonic Group 1 - Bin 8 phase	03 / 04	0.001°	0152	2	B152	2
Interharmonic Group 1 - Bin 9 magnitude	03 / 04	0.001% / mV / mA	0154	2	B154	2
Interharmonic Group 1 - Bin 9 phase	03 / 04	0.001°	0156	2	B156	2
Interharmonic Group 1 - Bin 10 magnitude	03 / 04	0.001% / mV / mA	0158	2	B158	2
Interharmonic Group 1 - Bin 10 phase	03 / 04	0.001°	015A	2	B15A	2
Interharmonic Group 1 - Bin 11 magnitude	03 / 04	0.001% / mV / mA	015C	2	B15C	2
Interharmonic Group 1 - Bin 11 phase	03 / 04	0.001°	015E	2	B15E	2
2nd Harmonic Component - Magnitude	03 / 04	0.001% / mV / mA	0160	2	B160	2
2nd Harmonic Component - Phase	03 / 04	0.001°	0162	2	B162	2
Interharmonic Group 2 - Bin 1 magnitude	03 / 04	0.001% / mV / mA	0164	2	B164	2
Interharmonic Group 2 - Bin 1 phase	03 / 04	0.001°	0166	2	B166	2
Interharmonic Group 2 - Bin 2 magnitude	03 / 04	0.001% / mV / mA	0168	2	B168	2
Interharmonic Group 2 - Bin 2 phase	03 / 04	0.001°	016A	2	B16A	2
Interharmonic Group 2 - Bin 3 magnitude	03 / 04	0.001% / mV / mA	016C	2	B16C	2
Interharmonic Group 2 - Bin 3 phase	03 / 04	0.001°	016E	2	B16E	2
Interharmonic Group 2 - Bin 4 magnitude	03 / 04	0.001% / mV / mA	0170	2	B170	2
Interharmonic Group 2 - Bin 4 phase	03 / 04	0.001°	0172	2	B172	2
Interharmonic Group 2 - Bin 5 magnitude	03 / 04	0.001% / mV / mA	0174	2	B174	2
Interharmonic Group 2 - Bin 5 phase	03 / 04	0.001°	0176	2	B176	2
Interharmonic Group 2 - Bin 6 magnitude	03 / 04	0.001% / mV / mA	0178	2	B178	2
Interharmonic Group 2 - Bin 6 phase	03 / 04	0.001°	017A	2	B17A	2

Parameter	F. code (Hex)	M.U.	INTEGER		IEEE	
			Register (Hex)	Words	Register (Hex)	Words
VOLTAGE & CURRENT HARMONICS & INTERHARMONICS MAGNITUDE&PHASE - fnom=60 Hz						
Interharmonic Group 2 - Bin 7 magnitude	03 / 04	0.001% / mV / mA	017C	2	B17C	2
Interharmonic Group 2 - Bin 7 phase	03 / 04	0.001°	017E	2	B17E	2
Interharmonic Group 2 - Bin 8 magnitude	03 / 04	0.001% / mV / mA	0180	2	B180	2
Interharmonic Group 2 - Bin 8 phase	03 / 04	0.001°	0182	2	B182	2
Interharmonic Group 2 - Bin 9 magnitude	03 / 04	0.001% / mV / mA	0184	2	B184	2
Interharmonic Group 2 - Bin 9 phase	03 / 04	0.001°	0186	2	B186	2
Interharmonic Group 2 - Bin 10 magnitude	03 / 04	0.001% / mV / mA	0188	2	B188	2
Interharmonic Group 2 - Bin 10 phase	03 / 04	0.001°	018A	2	B18A	2
Interharmonic Group 2 - Bin 11 magnitude	03 / 04	0.001% / mV / mA	018C	2	B18C	2
Interharmonic Group 2 - Bin 11 phase	03 / 04	0.001°	018E	2	B18E	2
3rd Harmonic Component - Magnitude	03 / 04	0.001% / mV / mA	0190	2	B190	2
3rd Harmonic Component - Phase	03 / 04	0.001°	0192	2	B192	2
Interharmonic Group 3 - Bin 1 magnitude	03 / 04	0.001% / mV / mA	0194	2	B194	2
Interharmonic Group 3 - Bin 1 phase	03 / 04	0.001°	0196	2	B196	2
Interharmonic Group 3 - Bin 2 magnitude	03 / 04	0.001% / mV / mA	0198	2	B198	2
Interharmonic Group 3 - Bin 2 phase	03 / 04	0.001°	019A	2	B19A	2
Interharmonic Group 3 - Bin 3 magnitude	03 / 04	0.001% / mV / mA	019C	2	B19C	2
Interharmonic Group 3 - Bin 3 phase	03 / 04	0.001°	019E	2	B19E	2
Interharmonic Group 3 - Bin 4 magnitude	03 / 04	0.001% / mV / mA	01A0	2	B1A0	2
Interharmonic Group 3 - Bin 4 phase	03 / 04	0.001°	01A2	2	B1A2	2
Interharmonic Group 3 - Bin 5 magnitude	03 / 04	0.001% / mV / mA	01A4	2	B1A4	2
Interharmonic Group 3 - Bin 5 phase	03 / 04	0.001°	01A6	2	B1A6	2
Interharmonic Group 3 - Bin 6 magnitude	03 / 04	0.001% / mV / mA	01A8	2	B1A8	2
Interharmonic Group 3 - Bin 6 phase	03 / 04	0.001°	01AA	2	B1AA	2
Interharmonic Group 3 - Bin 7 magnitude	03 / 04	0.001% / mV / mA	01AC	2	B1AC	2
Interharmonic Group 3 - Bin 7 phase	03 / 04	0.001°	01AE	2	B1AE	2
Interharmonic Group 3 - Bin 8 magnitude	03 / 04	0.001% / mV / mA	01B0	2	B1B0	2
Interharmonic Group 3 - Bin 8 phase	03 / 04	0.001°	01B2	2	B1B2	2
Interharmonic Group 3 - Bin 9 magnitude	03 / 04	0.001% / mV / mA	01B4	2	B1B4	2
Interharmonic Group 3 - Bin 9 phase	03 / 04	0.001°	01B6	2	B1B6	2
Interharmonic Group 3 - Bin 10 magnitude	03 / 04	0.001% / mV / mA	01B8	2	B1B8	2
Interharmonic Group 3 - Bin 10 phase	03 / 04	0.001°	01BA	2	B1BA	2
Interharmonic Group 3 - Bin 11 magnitude	03 / 04	0.001% / mV / mA	01BC	2	B1BC	2
Interharmonic Group 3 - Bin 11 phase	03 / 04	0.001°	01BE	2	B1BE	2
4th Harmonic Component - Magnitude	03 / 04	0.001% / mV / mA	01C0	2	B1C0	2
4th Harmonic Component - Phase	03 / 04	0.001°	01C2	2	B1C2	2
Interharmonic Group 4 - Bin 1 magnitude	03 / 04	0.001% / mV / mA	01C4	2	B1C4	2
Interharmonic Group 4 - Bin 1 phase	03 / 04	0.001°	01C6	2	B1C6	2
Interharmonic Group 4 - Bin 2 magnitude	03 / 04	0.001% / mV / mA	01C8	2	B1C8	2
Interharmonic Group 4 - Bin 2 phase	03 / 04	0.001°	01CA	2	B1CA	2
Interharmonic Group 4 - Bin 3 magnitude	03 / 04	0.001% / mV / mA	01CC	2	B1CC	2
Interharmonic Group 4 - Bin 3 phase	03 / 04	0.001°	01CE	2	B1CE	2
Interharmonic Group 4 - Bin 4 magnitude	03 / 04	0.001% / mV / mA	01D0	2	B1D0	2
Interharmonic Group 4 - Bin 4 phase	03 / 04	0.001°	01D2	2	B1D2	2
Interharmonic Group 4 - Bin 5 magnitude	03 / 04	0.001% / mV / mA	01D4	2	B1D4	2
Interharmonic Group 4 - Bin 5 phase	03 / 04	0.001°	01D6	2	B1D6	2
Interharmonic Group 4 - Bin 6 magnitude	03 / 04	0.001% / mV / mA	01D8	2	B1D8	2
Interharmonic Group 4 - Bin 6 phase	03 / 04	0.001°	01DA	2	B1DA	2
Interharmonic Group 4 - Bin 7 magnitude	03 / 04	0.001% / mV / mA	01DC	2	B1DC	2
Interharmonic Group 4 - Bin 7 phase	03 / 04	0.001°	01DE	2	B1DE	2

Parameter	F. code (Hex)	M.U.	INTEGER		IEEE	
			Register (Hex)	Words	Register (Hex)	Words
VOLTAGE & CURRENT HARMONICS & INTERHARMONICS MAGNITUDE&PHASE - fnom=60 Hz						
Interharmonic Group 4 - Bin 8 magnitude	03 / 04	0.001% / mV / mA	01E0	2	B1E0	2
Interharmonic Group 4 - Bin 8 phase	03 / 04	0.001°	01E2	2	B1E2	2
Interharmonic Group 4 - Bin 9 magnitude	03 / 04	0.001% / mV / mA	01E4	2	B1E4	2
Interharmonic Group 4 - Bin 9 phase	03 / 04	0.001°	01E6	2	B1E6	2
Interharmonic Group 4 - Bin 10 magnitude	03 / 04	0.001% / mV / mA	01E8	2	B1E8	2
Interharmonic Group 4 - Bin 10 phase	03 / 04	0.001°	01EA	2	B1EA	2
Interharmonic Group 4 - Bin 11 magnitude	03 / 04	0.001% / mV / mA	01EC	2	B1EC	2
Interharmonic Group 4 - Bin 11 phase	03 / 04	0.001°	01EE	2	B1EE	2
5th Harmonic Component - Magnitude	03 / 04	0.001% / mV / mA	01F0	2	B1F0	2
5th Harmonic Component - Phase	03 / 04	0.001°	01F2	2	B1F2	2
Interharmonic Group 5 - Bin 1 magnitude	03 / 04	0.001% / mV / mA	01F4	2	B1F4	2
Interharmonic Group 5 - Bin 1 phase	03 / 04	0.001°	01F6	2	B1F6	2
Interharmonic Group 5 - Bin 2 magnitude	03 / 04	0.001% / mV / mA	01F8	2	B1F8	2
Interharmonic Group 5 - Bin 2 phase	03 / 04	0.001°	01FA	2	B1FA	2
Interharmonic Group 5 - Bin 3 magnitude	03 / 04	0.001% / mV / mA	01FC	2	B1FC	2
Interharmonic Group 5 - Bin 3 phase	03 / 04	0.001°	01FE	2	B1FE	2
Interharmonic Group 5 - Bin 4 magnitude	03 / 04	0.001% / mV / mA	0200	2	B200	2
Interharmonic Group 5 - Bin 4 phase	03 / 04	0.001°	0202	2	B202	2
Interharmonic Group 5 - Bin 5 magnitude	03 / 04	0.001% / mV / mA	0204	2	B204	2
Interharmonic Group 5 - Bin 5 phase	03 / 04	0.001°	0206	2	B206	2
Interharmonic Group 5 - Bin 6 magnitude	03 / 04	0.001% / mV / mA	0208	2	B208	2
Interharmonic Group 5 - Bin 6 phase	03 / 04	0.001°	020A	2	B20A	2
Interharmonic Group 5 - Bin 7 magnitude	03 / 04	0.001% / mV / mA	020C	2	B20C	2
Interharmonic Group 5 - Bin 7 phase	03 / 04	0.001°	020E	2	B20E	2
Interharmonic Group 5 - Bin 8 magnitude	03 / 04	0.001% / mV / mA	0210	2	B210	2
Interharmonic Group 5 - Bin 8 phase	03 / 04	0.001°	0212	2	B212	2
Interharmonic Group 5 - Bin 9 magnitude	03 / 04	0.001% / mV / mA	0214	2	B214	2
Interharmonic Group 5 - Bin 9 phase	03 / 04	0.001°	0216	2	B216	2
Interharmonic Group 5 - Bin 10 magnitude	03 / 04	0.001% / mV / mA	0218	2	B218	2
Interharmonic Group 5 - Bin 10 phase	03 / 04	0.001°	021A	2	B21A	2
Interharmonic Group 5 - Bin 11 magnitude	03 / 04	0.001% / mV / mA	021C	2	B21C	2
Interharmonic Group 5 - Bin 11 phase	03 / 04	0.001°	021E	2	B21E	2
6th Harmonic Component - Magnitude	03 / 04	0.001% / mV / mA	0220	2	B220	2
6th Harmonic Component - Phase	03 / 04	0.001°	0222	2	B222	2
Interharmonic Group 6 - Bin 1 magnitude	03 / 04	0.001% / mV / mA	0224	2	B224	2
Interharmonic Group 6 - Bin 1 phase	03 / 04	0.001°	0226	2	B226	2
Interharmonic Group 6 - Bin 2 magnitude	03 / 04	0.001% / mV / mA	0228	2	B228	2
Interharmonic Group 6 - Bin 2 phase	03 / 04	0.001°	022A	2	B22A	2
Interharmonic Group 6 - Bin 3 magnitude	03 / 04	0.001% / mV / mA	022C	2	B22C	2
Interharmonic Group 6 - Bin 3 phase	03 / 04	0.001°	022E	2	B22E	2
Interharmonic Group 6 - Bin 4 magnitude	03 / 04	0.001% / mV / mA	0230	2	B230	2
Interharmonic Group 6 - Bin 4 phase	03 / 04	0.001°	0232	2	B232	2
Interharmonic Group 6 - Bin 5 magnitude	03 / 04	0.001% / mV / mA	0234	2	B234	2
Interharmonic Group 6 - Bin 5 phase	03 / 04	0.001°	0236	2	B236	2
Interharmonic Group 6 - Bin 6 magnitude	03 / 04	0.001% / mV / mA	0238	2	B238	2
Interharmonic Group 6 - Bin 6 phase	03 / 04	0.001°	023A	2	B23A	2
Interharmonic Group 6 - Bin 7 magnitude	03 / 04	0.001% / mV / mA	023C	2	B23C	2
Interharmonic Group 6 - Bin 7 phase	03 / 04	0.001°	023E	2	B23E	2
Interharmonic Group 6 - Bin 8 magnitude	03 / 04	0.001% / mV / mA	0240	2	B240	2
Interharmonic Group 6 - Bin 8 phase	03 / 04	0.001°	0242	2	B242	2

Parameter	F. code (Hex)	M.U.	INTEGER		IEEE	
			Register (Hex)	Words	Register (Hex)	Words
VOLTAGE & CURRENT HARMONICS & INTERHARMONICS MAGNITUDE&PHASE - fnom=60 Hz						
Interharmonic Group 6 - Bin 9 magnitude	03 / 04	0.001% / mV / mA	0244	2	B244	2
Interharmonic Group 6 - Bin 9 phase	03 / 04	0.001°	0246	2	B246	2
Interharmonic Group 6 - Bin 10 magnitude	03 / 04	0.001% / mV / mA	0248	2	B248	2
Interharmonic Group 6 - Bin 10 phase	03 / 04	0.001°	024A	2	B24A	2
Interharmonic Group 6 - Bin 11 magnitude	03 / 04	0.001% / mV / mA	024C	2	B24C	2
Interharmonic Group 6 - Bin 11 phase	03 / 04	0.001°	024E	2	B24E	2
7th Harmonic Component - Magnitude	03 / 04	0.001% / mV / mA	0250	2	B250	2
7th Harmonic Component - Phase	03 / 04	0.001°	0252	2	B252	2
Interharmonic Group 7 - Bin 1 magnitude	03 / 04	0.001% / mV / mA	0254	2	B254	2
Interharmonic Group 7 - Bin 1 phase	03 / 04	0.001°	0256	2	B256	2
Interharmonic Group 7 - Bin 2 magnitude	03 / 04	0.001% / mV / mA	0258	2	B258	2
Interharmonic Group 7 - Bin 2 phase	03 / 04	0.001°	025A	2	B25A	2
Interharmonic Group 7 - Bin 3 magnitude	03 / 04	0.001% / mV / mA	025C	2	B25C	2
Interharmonic Group 7 - Bin 3 phase	03 / 04	0.001°	025E	2	B25E	2
Interharmonic Group 7 - Bin 4 magnitude	03 / 04	0.001% / mV / mA	0260	2	B260	2
Interharmonic Group 7 - Bin 4 phase	03 / 04	0.001°	0262	2	B262	2
Interharmonic Group 7 - Bin 5 magnitude	03 / 04	0.001% / mV / mA	0264	2	B264	2
Interharmonic Group 7 - Bin 5 phase	03 / 04	0.001°	0266	2	B266	2
Interharmonic Group 7 - Bin 6 magnitude	03 / 04	0.001% / mV / mA	0268	2	B268	2
Interharmonic Group 7 - Bin 6 phase	03 / 04	0.001°	026A	2	B26A	2
Interharmonic Group 7 - Bin 7 magnitude	03 / 04	0.001% / mV / mA	026C	2	B26C	2
Interharmonic Group 7 - Bin 7 phase	03 / 04	0.001°	026E	2	B26E	2
Interharmonic Group 7 - Bin 8 magnitude	03 / 04	0.001% / mV / mA	0270	2	B270	2
Interharmonic Group 7 - Bin 8 phase	03 / 04	0.001°	0272	2	B272	2
Interharmonic Group 7 - Bin 9 magnitude	03 / 04	0.001% / mV / mA	0274	2	B274	2
Interharmonic Group 7 - Bin 9 phase	03 / 04	0.001°	0276	2	B276	2
Interharmonic Group 7 - Bin 10 magnitude	03 / 04	0.001% / mV / mA	0278	2	B278	2
Interharmonic Group 7 - Bin 10 phase	03 / 04	0.001°	027A	2	B27A	2
Interharmonic Group 7 - Bin 11 magnitude	03 / 04	0.001% / mV / mA	027C	2	B27C	2
Interharmonic Group 7 - Bin 11 phase	03 / 04	0.001°	027E	2	B27E	2
8th Harmonic Component - Magnitude	03 / 04	0.001% / mV / mA	0280	2	B280	2
8th Harmonic Component - Phase	03 / 04	0.001°	0282	2	B282	2
Interharmonic Group 8 - Bin 1 magnitude	03 / 04	0.001% / mV / mA	0284	2	B284	2
Interharmonic Group 8 - Bin 1 phase	03 / 04	0.001°	0286	2	B286	2
Interharmonic Group 8 - Bin 2 magnitude	03 / 04	0.001% / mV / mA	0288	2	B288	2
Interharmonic Group 8 - Bin 2 phase	03 / 04	0.001°	028A	2	B28A	2
Interharmonic Group 8 - Bin 3 magnitude	03 / 04	0.001% / mV / mA	028C	2	B28C	2
Interharmonic Group 8 - Bin 3 phase	03 / 04	0.001°	028E	2	B28E	2
Interharmonic Group 8 - Bin 4 magnitude	03 / 04	0.001% / mV / mA	0290	2	B290	2
Interharmonic Group 8 - Bin 4 phase	03 / 04	0.001°	0292	2	B292	2
Interharmonic Group 8 - Bin 5 magnitude	03 / 04	0.001% / mV / mA	0294	2	B294	2
Interharmonic Group 8 - Bin 5 phase	03 / 04	0.001°	0296	2	B296	2
Interharmonic Group 8 - Bin 6 magnitude	03 / 04	0.001% / mV / mA	0298	2	B298	2
Interharmonic Group 8 - Bin 6 phase	03 / 04	0.001°	029A	2	B29A	2
Interharmonic Group 8 - Bin 7 magnitude	03 / 04	0.001% / mV / mA	029C	2	B29C	2
Interharmonic Group 8 - Bin 7 phase	03 / 04	0.001°	029E	2	B29E	2
Interharmonic Group 8 - Bin 8 magnitude	03 / 04	0.001% / mV / mA	02A0	2	B2A0	2
Interharmonic Group 8 - Bin 8 phase	03 / 04	0.001°	02A2	2	B2A2	2
Interharmonic Group 8 - Bin 9 magnitude	03 / 04	0.001% / mV / mA	02A4	2	B2A4	2
Interharmonic Group 8 - Bin 9 phase	03 / 04	0.001°	02A6	2	B2A6	2

Parameter	F. code (Hex)	M.U.	INTEGER		IEEE	
			Register (Hex)	Words	Register (Hex)	Words
VOLTAGE & CURRENT HARMONICS & INTERHARMONICS MAGNITUDE&PHASE - fnom=60 Hz						
Interharmonic Group 8 - Bin 10 magnitude	03 / 04	0.001% / mV / mA	02A8	2	B2A8	2
Interharmonic Group 8 - Bin 10 phase	03 / 04	0.001°	02AA	2	B2AA	2
Interharmonic Group 8 - Bin 11 magnitude	03 / 04	0.001% / mV / mA	02AC	2	B2AC	2
Interharmonic Group 8 - Bin 11 phase	03 / 04	0.001°	02AE	2	B2AE	2
9th Harmonic Component - Magnitude	03 / 04	0.001% / mV / mA	02B0	2	B2B0	2
9th Harmonic Component - Phase	03 / 04	0.001°	02B2	2	B2B2	2
Interharmonic Group 9 - Bin 1 magnitude	03 / 04	0.001% / mV / mA	02B4	2	B2B4	2
Interharmonic Group 9 - Bin 1 phase	03 / 04	0.001°	02B6	2	B2B6	2
Interharmonic Group 9 - Bin 2 magnitude	03 / 04	0.001% / mV / mA	02B8	2	B2B8	2
Interharmonic Group 9 - Bin 2 phase	03 / 04	0.001°	02BA	2	B2BA	2
Interharmonic Group 9 - Bin 3 magnitude	03 / 04	0.001% / mV / mA	02BC	2	B2BC	2
Interharmonic Group 9 - Bin 3 phase	03 / 04	0.001°	02BE	2	B2BE	2
Interharmonic Group 9 - Bin 4 magnitude	03 / 04	0.001% / mV / mA	02C0	2	B2C0	2
Interharmonic Group 9 - Bin 4 phase	03 / 04	0.001°	02C2	2	B2C2	2
Interharmonic Group 9 - Bin 5 magnitude	03 / 04	0.001% / mV / mA	02C4	2	B2C4	2
Interharmonic Group 9 - Bin 5 phase	03 / 04	0.001°	02C6	2	B2C6	2
Interharmonic Group 9 - Bin 6 magnitude	03 / 04	0.001% / mV / mA	02C8	2	B2C8	2
Interharmonic Group 9 - Bin 6 phase	03 / 04	0.001°	02CA	2	B2CA	2
Interharmonic Group 9 - Bin 7 magnitude	03 / 04	0.001% / mV / mA	02CC	2	B2CC	2
Interharmonic Group 9 - Bin 7 phase	03 / 04	0.001°	02CE	2	B2CE	2
Interharmonic Group 9 - Bin 8 magnitude	03 / 04	0.001% / mV / mA	02D0	2	B2D0	2
Interharmonic Group 9 - Bin 8 phase	03 / 04	0.001°	02D2	2	B2D2	2
Interharmonic Group 9 - Bin 9 magnitude	03 / 04	0.001% / mV / mA	02D4	2	B2D4	2
Interharmonic Group 9 - Bin 9 phase	03 / 04	0.001°	02D6	2	B2D6	2
Interharmonic Group 9 - Bin 10 magnitude	03 / 04	0.001% / mV / mA	02D8	2	B2D8	2
Interharmonic Group 9 - Bin 10 phase	03 / 04	0.001°	02DA	2	B2DA	2
Interharmonic Group 9 - Bin 11 magnitude	03 / 04	0.001% / mV / mA	02DC	2	B2DC	2
Interharmonic Group 9 - Bin 11 phase	03 / 04	0.001°	02DE	2	B2DE	2
10th Harmonic Component - Magnitude	03 / 04	0.001% / mV / mA	02E0	2	B2E0	2
10th Harmonic Component - Phase	03 / 04	0.001°	02E2	2	B2E2	2
Interharmonic Group 10 - Bin 1 magnitude	03 / 04	0.001% / mV / mA	02E4	2	B2E4	2
Interharmonic Group 10 - Bin 1 phase	03 / 04	0.001°	02E6	2	B2E6	2
Interharmonic Group 10 - Bin 2 magnitude	03 / 04	0.001% / mV / mA	02E8	2	B2E8	2
Interharmonic Group 10 - Bin 2 phase	03 / 04	0.001°	02EA	2	B2EA	2
Interharmonic Group 10 - Bin 3 magnitude	03 / 04	0.001% / mV / mA	02EC	2	B2EC	2
Interharmonic Group 10 - Bin 3 phase	03 / 04	0.001°	02EE	2	B2EE	2
Interharmonic Group 10 - Bin 4 magnitude	03 / 04	0.001% / mV / mA	02F0	2	B2F0	2
Interharmonic Group 10 - Bin 4 phase	03 / 04	0.001°	02F2	2	B2F2	2
Interharmonic Group 10 - Bin 5 magnitude	03 / 04	0.001% / mV / mA	02F4	2	B2F4	2
Interharmonic Group 10 - Bin 5 phase	03 / 04	0.001°	02F6	2	B2F6	2
Interharmonic Group 10 - Bin 6 magnitude	03 / 04	0.001% / mV / mA	02F8	2	B2F8	2
Interharmonic Group 10 - Bin 6 phase	03 / 04	0.001°	02FA	2	B2FA	2
Interharmonic Group 10 - Bin 7 magnitude	03 / 04	0.001% / mV / mA	02FC	2	B2FC	2
Interharmonic Group 10 - Bin 7 phase	03 / 04	0.001°	02FE	2	B2FE	2
Interharmonic Group 10 - Bin 8 magnitude	03 / 04	0.001% / mV / mA	0300	2	B300	2
Interharmonic Group 10 - Bin 8 phase	03 / 04	0.001°	0302	2	B302	2
Interharmonic Group 10 - Bin 9 magnitude	03 / 04	0.001% / mV / mA	0304	2	B304	2
Interharmonic Group 10 - Bin 9 phase	03 / 04	0.001°	0306	2	B306	2
Interharmonic Group 10 - Bin 10 magnitude	03 / 04	0.001% / mV / mA	0308	2	B308	2
Interharmonic Group 10 - Bin 10 phase	03 / 04	0.001°	030A	2	B30A	2

Parameter	F. code (Hex)	M.U.	INTEGER		IEEE	
			Register (Hex)	Words	Register (Hex)	Words
VOLTAGE & CURRENT HARMONICS & INTERHARMONICS MAGNITUDE&PHASE - f_{nom}=60 Hz						
Interharmonic Group 10 - Bin 11 magnitude	03 / 04	0.001% / mV / mA	030C	2	B30C	2
Interharmonic Group 10 - Bin 11 phase	03 / 04	0.001°	030E	2	B30E	2
11th Harmonic Component - Magnitude	03 / 04	0.001% / mV / mA	0310	2	B310	2
11th Harmonic Component - Phase	03 / 04	0.001°	0312	2	B312	2
Interharmonic Group 11 - Bin 1 magnitude	03 / 04	0.001% / mV / mA	0314	2	B314	2
Interharmonic Group 11 - Bin 1 phase	03 / 04	0.001°	0316	2	B316	2
Interharmonic Group 11 - Bin 2 magnitude	03 / 04	0.001% / mV / mA	0318	2	B318	2
Interharmonic Group 11 - Bin 2 phase	03 / 04	0.001°	031A	2	B31A	2
Interharmonic Group 11 - Bin 3 magnitude	03 / 04	0.001% / mV / mA	031C	2	B31C	2
Interharmonic Group 11 - Bin 3 phase	03 / 04	0.001°	031E	2	B31E	2
Interharmonic Group 11 - Bin 4 magnitude	03 / 04	0.001% / mV / mA	0320	2	B320	2
Interharmonic Group 11 - Bin 4 phase	03 / 04	0.001°	0322	2	B322	2
Interharmonic Group 11 - Bin 5 magnitude	03 / 04	0.001% / mV / mA	0324	2	B324	2
Interharmonic Group 11 - Bin 5 phase	03 / 04	0.001°	0326	2	B326	2
Interharmonic Group 11 - Bin 6 magnitude	03 / 04	0.001% / mV / mA	0328	2	B328	2
Interharmonic Group 11 - Bin 6 phase	03 / 04	0.001°	032A	2	B32A	2
Interharmonic Group 11 - Bin 7 magnitude	03 / 04	0.001% / mV / mA	032C	2	B32C	2
Interharmonic Group 11 - Bin 7 phase	03 / 04	0.001°	032E	2	B32E	2
Interharmonic Group 11 - Bin 8 magnitude	03 / 04	0.001% / mV / mA	0330	2	B330	2
Interharmonic Group 11 - Bin 8 phase	03 / 04	0.001°	0332	2	B332	2
Interharmonic Group 11 - Bin 9 magnitude	03 / 04	0.001% / mV / mA	0334	2	B334	2
Interharmonic Group 11 - Bin 9 phase	03 / 04	0.001°	0336	2	B336	2
Interharmonic Group 11 - Bin 10 magnitude	03 / 04	0.001% / mV / mA	0338	2	B338	2
Interharmonic Group 11 - Bin 10 phase	03 / 04	0.001°	033A	2	B33A	2
Interharmonic Group 11 - Bin 11 magnitude	03 / 04	0.001% / mV / mA	033C	2	B33C	2
Interharmonic Group 11 - Bin 11 phase	03 / 04	0.001°	033E	2	B33E	2
12th Harmonic Component - Magnitude	03 / 04	0.001% / mV / mA	0340	2	B340	2
12th Harmonic Component - Phase	03 / 04	0.001°	0342	2	B342	2
Interharmonic Group 12 - Bin 1 magnitude	03 / 04	0.001% / mV / mA	0344	2	B344	2
Interharmonic Group 12 - Bin 1 phase	03 / 04	0.001°	0346	2	B346	2
Interharmonic Group 12 - Bin 2 magnitude	03 / 04	0.001% / mV / mA	0348	2	B348	2
Interharmonic Group 12 - Bin 2 phase	03 / 04	0.001°	034A	2	B34A	2
Interharmonic Group 12 - Bin 3 magnitude	03 / 04	0.001% / mV / mA	034C	2	B34C	2
Interharmonic Group 12 - Bin 3 phase	03 / 04	0.001°	034E	2	B34E	2
Interharmonic Group 12 - Bin 4 magnitude	03 / 04	0.001% / mV / mA	0350	2	B350	2
Interharmonic Group 12 - Bin 4 phase	03 / 04	0.001°	0352	2	B352	2
Interharmonic Group 12 - Bin 5 magnitude	03 / 04	0.001% / mV / mA	0354	2	B354	2
Interharmonic Group 12 - Bin 5 phase	03 / 04	0.001°	0356	2	B356	2
Interharmonic Group 12 - Bin 6 magnitude	03 / 04	0.001% / mV / mA	0358	2	B358	2
Interharmonic Group 12 - Bin 6 phase	03 / 04	0.001°	035A	2	B35A	2
Interharmonic Group 12 - Bin 7 magnitude	03 / 04	0.001% / mV / mA	035C	2	B35C	2
Interharmonic Group 12 - Bin 7 phase	03 / 04	0.001°	035E	2	B35E	2
Interharmonic Group 12 - Bin 8 magnitude	03 / 04	0.001% / mV / mA	0360	2	B360	2
Interharmonic Group 12 - Bin 8 phase	03 / 04	0.001°	0362	2	B362	2
Interharmonic Group 12 - Bin 9 magnitude	03 / 04	0.001% / mV / mA	0364	2	B364	2
Interharmonic Group 12 - Bin 9 phase	03 / 04	0.001°	0366	2	B366	2
Interharmonic Group 12 - Bin 10 magnitude	03 / 04	0.001% / mV / mA	0368	2	B368	2
Interharmonic Group 12 - Bin 10 phase	03 / 04	0.001°	036A	2	B36A	2
Interharmonic Group 12 - Bin 11 magnitude	03 / 04	0.001% / mV / mA	036C	2	B36C	2
Interharmonic Group 12 - Bin 11 phase	03 / 04	0.001°	036E	2	B36E	2

Parameter	F. code (Hex)	M.U.	INTEGER		IEEE	
			Register (Hex)	Words	Register (Hex)	Words
VOLTAGE & CURRENT HARMONICS & INTERHARMONICS MAGNITUDE&PHASE - f_{nom}=60 Hz						
13th Harmonic Component - Magnitude	03 / 04	0.001% / mV / mA	0370	2	B370	2
13th Harmonic Component - Phase	03 / 04	0.001°	0372	2	B372	2
Interharmonic Group 13 - Bin 1 magnitude	03 / 04	0.001% / mV / mA	0374	2	B374	2
Interharmonic Group 13 - Bin 1 phase	03 / 04	0.001°	0376	2	B376	2
Interharmonic Group 13 - Bin 2 magnitude	03 / 04	0.001% / mV / mA	0378	2	B378	2
Interharmonic Group 13 - Bin 2 phase	03 / 04	0.001°	037A	2	B37A	2
Interharmonic Group 13 - Bin 3 magnitude	03 / 04	0.001% / mV / mA	037C	2	B37C	2
Interharmonic Group 13 - Bin 3 phase	03 / 04	0.001°	037E	2	B37E	2
Interharmonic Group 13 - Bin 4 magnitude	03 / 04	0.001% / mV / mA	0380	2	B380	2
Interharmonic Group 13 - Bin 4 phase	03 / 04	0.001°	0382	2	B382	2
Interharmonic Group 13 - Bin 5 magnitude	03 / 04	0.001% / mV / mA	0384	2	B384	2
Interharmonic Group 13 - Bin 5 phase	03 / 04	0.001°	0386	2	B386	2
Interharmonic Group 13 - Bin 6 magnitude	03 / 04	0.001% / mV / mA	0388	2	B388	2
Interharmonic Group 13 - Bin 6 phase	03 / 04	0.001°	038A	2	B38A	2
Interharmonic Group 13 - Bin 7 magnitude	03 / 04	0.001% / mV / mA	038C	2	B38C	2
Interharmonic Group 13 - Bin 7 phase	03 / 04	0.001°	038E	2	B38E	2
Interharmonic Group 13 - Bin 8 magnitude	03 / 04	0.001% / mV / mA	0390	2	B390	2
Interharmonic Group 13 - Bin 8 phase	03 / 04	0.001°	0392	2	B392	2
Interharmonic Group 13 - Bin 9 magnitude	03 / 04	0.001% / mV / mA	0394	2	B394	2
Interharmonic Group 13 - Bin 9 phase	03 / 04	0.001°	0396	2	B396	2
Interharmonic Group 13 - Bin 10 magnitude	03 / 04	0.001% / mV / mA	0398	2	B398	2
Interharmonic Group 13 - Bin 10 phase	03 / 04	0.001°	039A	2	B39A	2
Interharmonic Group 13 - Bin 11 magnitude	03 / 04	0.001% / mV / mA	039C	2	B39C	2
Interharmonic Group 13 - Bin 11 phase	03 / 04	0.001°	039E	2	B39E	2
14th Harmonic Component - Magnitude	03 / 04	0.001% / mV / mA	03A0	2	B3A0	2
14th Harmonic Component - Phase	03 / 04	0.001°	03A2	2	B3A2	2
Interharmonic Group 14 - Bin 1 magnitude	03 / 04	0.001% / mV / mA	03A4	2	B3A4	2
Interharmonic Group 14 - Bin 1 phase	03 / 04	0.001°	03A6	2	B3A6	2
Interharmonic Group 14 - Bin 2 magnitude	03 / 04	0.001% / mV / mA	03A8	2	B3A8	2
Interharmonic Group 14 - Bin 2 phase	03 / 04	0.001°	03AA	2	B3AA	2
Interharmonic Group 14 - Bin 3 magnitude	03 / 04	0.001% / mV / mA	03AC	2	B3AC	2
Interharmonic Group 14 - Bin 3 phase	03 / 04	0.001°	03AE	2	B3AE	2
Interharmonic Group 14 - Bin 4 magnitude	03 / 04	0.001% / mV / mA	03B0	2	B3B0	2
Interharmonic Group 14 - Bin 4 phase	03 / 04	0.001°	03B2	2	B3B2	2
Interharmonic Group 14 - Bin 5 magnitude	03 / 04	0.001% / mV / mA	03B4	2	B3B4	2
Interharmonic Group 14 - Bin 5 phase	03 / 04	0.001°	03B6	2	B3B6	2
Interharmonic Group 14 - Bin 6 magnitude	03 / 04	0.001% / mV / mA	03B8	2	B3B8	2
Interharmonic Group 14 - Bin 6 phase	03 / 04	0.001°	03BA	2	B3BA	2
Interharmonic Group 14 - Bin 7 magnitude	03 / 04	0.001% / mV / mA	03BC	2	B3BC	2
Interharmonic Group 14 - Bin 7 phase	03 / 04	0.001°	03BE	2	B3BE	2
Interharmonic Group 14 - Bin 8 magnitude	03 / 04	0.001% / mV / mA	03C0	2	B3C0	2
Interharmonic Group 14 - Bin 8 phase	03 / 04	0.001°	03C2	2	B3C2	2
Interharmonic Group 14 - Bin 9 magnitude	03 / 04	0.001% / mV / mA	03C4	2	B3C4	2
Interharmonic Group 14 - Bin 9 phase	03 / 04	0.001°	03C6	2	B3C6	2
Interharmonic Group 14 - Bin 10 magnitude	03 / 04	0.001% / mV / mA	03C8	2	B3C8	2
Interharmonic Group 14 - Bin 10 phase	03 / 04	0.001°	03CA	2	B3CA	2
Interharmonic Group 14 - Bin 11 magnitude	03 / 04	0.001% / mV / mA	03CC	2	B3CC	2
Interharmonic Group 14 - Bin 11 phase	03 / 04	0.001°	03CE	2	B3CE	2
15th Harmonic Component - Magnitude	03 / 04	0.001% / mV / mA	03D0	2	B3D0	2
15th Harmonic Component - Phase	03 / 04	0.001°	03D2	2	B3D2	2

Parameter	F. code (Hex)	M.U.	INTEGER		IEEE	
			Register (Hex)	Words	Register (Hex)	Words
VOLTAGE & CURRENT HARMONICS & INTERHARMONICS MAGNITUDE&PHASE - fnom=60 Hz						
Interharmonic Group 15 - Bin 1 magnitude	03 / 04	0.001% / mV / mA	03D4	2	B3D4	2
Interharmonic Group 15 - Bin 1 phase	03 / 04	0.001°	03D6	2	B3D6	2
Interharmonic Group 15 - Bin 2 magnitude	03 / 04	0.001% / mV / mA	03D8	2	B3D8	2
Interharmonic Group 15 - Bin 2 phase	03 / 04	0.001°	03DA	2	B3DA	2
Interharmonic Group 15 - Bin 3 magnitude	03 / 04	0.001% / mV / mA	03DC	2	B3DC	2
Interharmonic Group 15 - Bin 3 phase	03 / 04	0.001°	03DE	2	B3DE	2
Interharmonic Group 15 - Bin 4 magnitude	03 / 04	0.001% / mV / mA	03E0	2	B3E0	2
Interharmonic Group 15 - Bin 4 phase	03 / 04	0.001°	03E2	2	B3E2	2
Interharmonic Group 15 - Bin 5 magnitude	03 / 04	0.001% / mV / mA	03E4	2	B3E4	2
Interharmonic Group 15 - Bin 5 phase	03 / 04	0.001°	03E6	2	B3E6	2
Interharmonic Group 15 - Bin 6 magnitude	03 / 04	0.001% / mV / mA	03E8	2	B3E8	2
Interharmonic Group 15 - Bin 6 phase	03 / 04	0.001°	03EA	2	B3EA	2
Interharmonic Group 15 - Bin 7 magnitude	03 / 04	0.001% / mV / mA	03EC	2	B3EC	2
Interharmonic Group 15 - Bin 7 phase	03 / 04	0.001°	03EE	2	B3EE	2
Interharmonic Group 15 - Bin 8 magnitude	03 / 04	0.001% / mV / mA	03F0	2	B3F0	2
Interharmonic Group 15 - Bin 8 phase	03 / 04	0.001°	03F2	2	B3F2	2
Interharmonic Group 15 - Bin 9 magnitude	03 / 04	0.001% / mV / mA	03F4	2	B3F4	2
Interharmonic Group 15 - Bin 9 phase	03 / 04	0.001°	03F6	2	B3F6	2
Interharmonic Group 15 - Bin 10 magnitude	03 / 04	0.001% / mV / mA	03F8	2	B3F8	2
Interharmonic Group 15 - Bin 10 phase	03 / 04	0.001°	03FA	2	B3FA	2
Interharmonic Group 15 - Bin 11 magnitude	03 / 04	0.001% / mV / mA	03FC	2	B3FC	2
Interharmonic Group 15 - Bin 11 phase	03 / 04	0.001°	03FE	2	B3FE	2
16th Harmonic Component - Magnitude	03 / 04	0.001% / mV / mA	0400	2	B400	2
16th Harmonic Component - Phase	03 / 04	0.001°	0402	2	B402	2
Interharmonic Group 16 - Bin 1 magnitude	03 / 04	0.001% / mV / mA	0404	2	B404	2
Interharmonic Group 16 - Bin 1 phase	03 / 04	0.001°	0406	2	B406	2
Interharmonic Group 16 - Bin 2 magnitude	03 / 04	0.001% / mV / mA	0408	2	B408	2
Interharmonic Group 16 - Bin 2 phase	03 / 04	0.001°	040A	2	B40A	2
Interharmonic Group 16 - Bin 3 magnitude	03 / 04	0.001% / mV / mA	040C	2	B40C	2
Interharmonic Group 16 - Bin 3 phase	03 / 04	0.001°	040E	2	B40E	2
Interharmonic Group 16 - Bin 4 magnitude	03 / 04	0.001% / mV / mA	0410	2	B410	2
Interharmonic Group 16 - Bin 4 phase	03 / 04	0.001°	0412	2	B412	2
Interharmonic Group 16 - Bin 5 magnitude	03 / 04	0.001% / mV / mA	0414	2	B414	2
Interharmonic Group 16 - Bin 5 phase	03 / 04	0.001°	0416	2	B416	2
Interharmonic Group 16 - Bin 6 magnitude	03 / 04	0.001% / mV / mA	0418	2	B418	2
Interharmonic Group 16 - Bin 6 phase	03 / 04	0.001°	041A	2	B41A	2
Interharmonic Group 16 - Bin 7 magnitude	03 / 04	0.001% / mV / mA	041C	2	B41C	2
Interharmonic Group 16 - Bin 7 phase	03 / 04	0.001°	041E	2	B41E	2
Interharmonic Group 16 - Bin 8 magnitude	03 / 04	0.001% / mV / mA	0420	2	B420	2
Interharmonic Group 16 - Bin 8 phase	03 / 04	0.001°	0422	2	B422	2
Interharmonic Group 16 - Bin 9 magnitude	03 / 04	0.001% / mV / mA	0424	2	B424	2
Interharmonic Group 16 - Bin 9 phase	03 / 04	0.001°	0426	2	B426	2
Interharmonic Group 16 - Bin 10 magnitude	03 / 04	0.001% / mV / mA	0428	2	B428	2
Interharmonic Group 16 - Bin 10 phase	03 / 04	0.001°	042A	2	B42A	2
Interharmonic Group 16 - Bin 11 magnitude	03 / 04	0.001% / mV / mA	042C	2	B42C	2
Interharmonic Group 16 - Bin 11 phase	03 / 04	0.001°	042E	2	B42E	2
17th Harmonic Component - Magnitude	03 / 04	0.001% / mV / mA	0430	2	B430	2
17th Harmonic Component - Phase	03 / 04	0.001°	0432	2	B432	2
Interharmonic Group 17 - Bin 1 magnitude	03 / 04	0.001% / mV / mA	0434	2	B434	2
Interharmonic Group 17 - Bin 1 phase	03 / 04	0.001°	0436	2	B436	2

Parameter	F. code (Hex)	M.U.	INTEGER		IEEE	
			Register (Hex)	Words	Register (Hex)	Words
VOLTAGE & CURRENT HARMONICS & INTERHARMONICS MAGNITUDE&PHASE - fnom=60 Hz						
Interharmonic Group 17 - Bin 2 magnitude	03 / 04	0.001% / mV / mA	0438	2	B438	2
Interharmonic Group 17 - Bin 2 phase	03 / 04	0.001°	043A	2	B43A	2
Interharmonic Group 17 - Bin 3 magnitude	03 / 04	0.001% / mV / mA	043C	2	B43C	2
Interharmonic Group 17 - Bin 3 phase	03 / 04	0.001°	043E	2	B43E	2
Interharmonic Group 17 - Bin 4 magnitude	03 / 04	0.001% / mV / mA	0440	2	B440	2
Interharmonic Group 17 - Bin 4 phase	03 / 04	0.001°	0442	2	B442	2
Interharmonic Group 17 - Bin 5 magnitude	03 / 04	0.001% / mV / mA	0444	2	B444	2
Interharmonic Group 17 - Bin 5 phase	03 / 04	0.001°	0446	2	B446	2
Interharmonic Group 17 - Bin 6 magnitude	03 / 04	0.001% / mV / mA	0448	2	B448	2
Interharmonic Group 17 - Bin 6 phase	03 / 04	0.001°	044A	2	B44A	2
Interharmonic Group 17 - Bin 7 magnitude	03 / 04	0.001% / mV / mA	044C	2	B44C	2
Interharmonic Group 17 - Bin 7 phase	03 / 04	0.001°	044E	2	B44E	2
Interharmonic Group 17 - Bin 8 magnitude	03 / 04	0.001% / mV / mA	0450	2	B450	2
Interharmonic Group 17 - Bin 8 phase	03 / 04	0.001°	0452	2	B452	2
Interharmonic Group 17 - Bin 9 magnitude	03 / 04	0.001% / mV / mA	0454	2	B454	2
Interharmonic Group 17 - Bin 9 phase	03 / 04	0.001°	0456	2	B456	2
Interharmonic Group 17 - Bin 10 magnitude	03 / 04	0.001% / mV / mA	0458	2	B458	2
Interharmonic Group 17 - Bin 10 phase	03 / 04	0.001°	045A	2	B45A	2
Interharmonic Group 17 - Bin 11 magnitude	03 / 04	0.001% / mV / mA	045C	2	B45C	2
Interharmonic Group 17 - Bin 11 phase	03 / 04	0.001°	045E	2	B45E	2
18th Harmonic Component - Magnitude	03 / 04	0.001% / mV / mA	0460	2	B460	2
18th Harmonic Component - Phase	03 / 04	0.001°	0462	2	B462	2
Interharmonic Group 18 - Bin 1 magnitude	03 / 04	0.001% / mV / mA	0464	2	B464	2
Interharmonic Group 18 - Bin 1 phase	03 / 04	0.001°	0466	2	B466	2
Interharmonic Group 18 - Bin 2 magnitude	03 / 04	0.001% / mV / mA	0468	2	B468	2
Interharmonic Group 18 - Bin 2 phase	03 / 04	0.001°	046A	2	B46A	2
Interharmonic Group 18 - Bin 3 magnitude	03 / 04	0.001% / mV / mA	046C	2	B46C	2
Interharmonic Group 18 - Bin 3 phase	03 / 04	0.001°	046E	2	B46E	2
Interharmonic Group 18 - Bin 4 magnitude	03 / 04	0.001% / mV / mA	0470	2	B470	2
Interharmonic Group 18 - Bin 4 phase	03 / 04	0.001°	0472	2	B472	2
Interharmonic Group 18 - Bin 5 magnitude	03 / 04	0.001% / mV / mA	0474	2	B474	2
Interharmonic Group 18 - Bin 5 phase	03 / 04	0.001°	0476	2	B476	2
Interharmonic Group 18 - Bin 6 magnitude	03 / 04	0.001% / mV / mA	0478	2	B478	2
Interharmonic Group 18 - Bin 6 phase	03 / 04	0.001°	047A	2	B47A	2
Interharmonic Group 18 - Bin 7 magnitude	03 / 04	0.001% / mV / mA	047C	2	B47C	2
Interharmonic Group 18 - Bin 7 phase	03 / 04	0.001°	047E	2	B47E	2
Interharmonic Group 18 - Bin 8 magnitude	03 / 04	0.001% / mV / mA	0480	2	B480	2
Interharmonic Group 18 - Bin 8 phase	03 / 04	0.001°	0482	2	B482	2
Interharmonic Group 18 - Bin 9 magnitude	03 / 04	0.001% / mV / mA	0484	2	B484	2
Interharmonic Group 18 - Bin 9 phase	03 / 04	0.001°	0486	2	B486	2
Interharmonic Group 18 - Bin 10 magnitude	03 / 04	0.001% / mV / mA	0488	2	B488	2
Interharmonic Group 18 - Bin 10 phase	03 / 04	0.001°	048A	2	B48A	2
Interharmonic Group 18 - Bin 11 magnitude	03 / 04	0.001% / mV / mA	048C	2	B48C	2
Interharmonic Group 18 - Bin 11 phase	03 / 04	0.001°	048E	2	B48E	2
19th Harmonic Component - Magnitude	03 / 04	0.001% / mV / mA	0490	2	B490	2
19th Harmonic Component - Phase	03 / 04	0.001°	0492	2	B492	2
Interharmonic Group 19 - Bin 1 magnitude	03 / 04	0.001% / mV / mA	0494	2	B494	2
Interharmonic Group 19 - Bin 1 phase	03 / 04	0.001°	0496	2	B496	2
Interharmonic Group 19 - Bin 2 magnitude	03 / 04	0.001% / mV / mA	0498	2	B498	2
Interharmonic Group 19 - Bin 2 phase	03 / 04	0.001°	049A	2	B49A	2

Parameter	F. code (Hex)	M.U.	INTEGER		IEEE	
			Register (Hex)	Words	Register (Hex)	Words
VOLTAGE & CURRENT HARMONICS & INTERHARMONICS MAGNITUDE&PHASE - fnom=60 Hz						
Interharmonic Group 19 - Bin 3 magnitude	03 / 04	0.001% / mV / mA	049C	2	B49C	2
Interharmonic Group 19 - Bin 3 phase	03 / 04	0.001°	049E	2	B49E	2
Interharmonic Group 19 - Bin 4 magnitude	03 / 04	0.001% / mV / mA	04A0	2	B4A0	2
Interharmonic Group 19 - Bin 4 phase	03 / 04	0.001°	04A2	2	B4A2	2
Interharmonic Group 19 - Bin 5 magnitude	03 / 04	0.001% / mV / mA	04A4	2	B4A4	2
Interharmonic Group 19 - Bin 5 phase	03 / 04	0.001°	04A6	2	B4A6	2
Interharmonic Group 19 - Bin 6 magnitude	03 / 04	0.001% / mV / mA	04A8	2	B4A8	2
Interharmonic Group 19 - Bin 6 phase	03 / 04	0.001°	04AA	2	B4AA	2
Interharmonic Group 19 - Bin 7 magnitude	03 / 04	0.001% / mV / mA	04AC	2	B4AC	2
Interharmonic Group 19 - Bin 7 phase	03 / 04	0.001°	04AE	2	B4AE	2
Interharmonic Group 19 - Bin 8 magnitude	03 / 04	0.001% / mV / mA	04B0	2	B4B0	2
Interharmonic Group 19 - Bin 8 phase	03 / 04	0.001°	04B2	2	B4B2	2
Interharmonic Group 19 - Bin 9 magnitude	03 / 04	0.001% / mV / mA	04B4	2	B4B4	2
Interharmonic Group 19 - Bin 9 phase	03 / 04	0.001°	04B6	2	B4B6	2
Interharmonic Group 19 - Bin 10 magnitude	03 / 04	0.001% / mV / mA	04B8	2	B4B8	2
Interharmonic Group 19 - Bin 10 phase	03 / 04	0.001°	04BA	2	B4BA	2
Interharmonic Group 19 - Bin 11 magnitude	03 / 04	0.001% / mV / mA	04BC	2	B4BC	2
Interharmonic Group 19 - Bin 11 phase	03 / 04	0.001°	04BE	2	B4BE	2
20th Harmonic Component - Magnitude	03 / 04	0.001% / mV / mA	04C0	2	B4C0	2
20th Harmonic Component - Phase	03 / 04	0.001°	04C2	2	B4C2	2
Interharmonic Group 20 - Bin 1 magnitude	03 / 04	0.001% / mV / mA	04C4	2	B4C4	2
Interharmonic Group 20 - Bin 1 phase	03 / 04	0.001°	04C6	2	B4C6	2
Interharmonic Group 20 - Bin 2 magnitude	03 / 04	0.001% / mV / mA	04C8	2	B4C8	2
Interharmonic Group 20 - Bin 2 phase	03 / 04	0.001°	04CA	2	B4CA	2
Interharmonic Group 20 - Bin 3 magnitude	03 / 04	0.001% / mV / mA	04CC	2	B4CC	2
Interharmonic Group 20 - Bin 3 phase	03 / 04	0.001°	04CE	2	B4CE	2
Interharmonic Group 20 - Bin 4 magnitude	03 / 04	0.001% / mV / mA	04D0	2	B4D0	2
Interharmonic Group 20 - Bin 4 phase	03 / 04	0.001°	04D2	2	B4D2	2
Interharmonic Group 20 - Bin 5 magnitude	03 / 04	0.001% / mV / mA	04D4	2	B4D4	2
Interharmonic Group 20 - Bin 5 phase	03 / 04	0.001°	04D6	2	B4D6	2
Interharmonic Group 20 - Bin 6 magnitude	03 / 04	0.001% / mV / mA	04D8	2	B4D8	2
Interharmonic Group 20 - Bin 6 phase	03 / 04	0.001°	04DA	2	B4DA	2
Interharmonic Group 20 - Bin 7 magnitude	03 / 04	0.001% / mV / mA	04DC	2	B4DC	2
Interharmonic Group 20 - Bin 7 phase	03 / 04	0.001°	04DE	2	B4DE	2
Interharmonic Group 20 - Bin 8 magnitude	03 / 04	0.001% / mV / mA	04E0	2	B4E0	2
Interharmonic Group 20 - Bin 8 phase	03 / 04	0.001°	04E2	2	B4E2	2
Interharmonic Group 20 - Bin 9 magnitude	03 / 04	0.001% / mV / mA	04E4	2	B4E4	2
Interharmonic Group 20 - Bin 9 phase	03 / 04	0.001°	04E6	2	B4E6	2
Interharmonic Group 20 - Bin 10 magnitude	03 / 04	0.001% / mV / mA	04E8	2	B4E8	2
Interharmonic Group 20 - Bin 10 phase	03 / 04	0.001°	04EA	2	B4EA	2
Interharmonic Group 20 - Bin 11 magnitude	03 / 04	0.001% / mV / mA	04EC	2	B4EC	2
Interharmonic Group 20 - Bin 11 phase	03 / 04	0.001°	04EE	2	B4EE	2
21st Harmonic Component - Magnitude	03 / 04	0.001% / mV / mA	04F0	2	B4F0	2
21st Harmonic Component - Phase	03 / 04	0.001°	04F2	2	B4F2	2
Interharmonic Group 21 - Bin 1 magnitude	03 / 04	0.001% / mV / mA	04F4	2	B4F4	2
Interharmonic Group 21 - Bin 1 phase	03 / 04	0.001°	04F6	2	B4F6	2
Interharmonic Group 21 - Bin 2 magnitude	03 / 04	0.001% / mV / mA	04F8	2	B4F8	2
Interharmonic Group 21 - Bin 2 phase	03 / 04	0.001°	04FA	2	B4FA	2
Interharmonic Group 21 - Bin 3 magnitude	03 / 04	0.001% / mV / mA	04FC	2	B4FC	2
Interharmonic Group 21 - Bin 3 phase	03 / 04	0.001°	04FE	2	B4FE	2

Parameter	F. code (Hex)	M.U.	INTEGER		IEEE	
			Register (Hex)	Words	Register (Hex)	Words
VOLTAGE & CURRENT HARMONICS & INTERHARMONICS MAGNITUDE&PHASE - fnom=60 Hz						
Interharmonic Group 21 - Bin 4 magnitude	03 / 04	0.001% / mV / mA	0500	2	B500	2
Interharmonic Group 21 - Bin 4 phase	03 / 04	0.001°	0502	2	B502	2
Interharmonic Group 21 - Bin 5 magnitude	03 / 04	0.001% / mV / mA	0504	2	B504	2
Interharmonic Group 21 - Bin 5 phase	03 / 04	0.001°	0506	2	B506	2
Interharmonic Group 21 - Bin 6 magnitude	03 / 04	0.001% / mV / mA	0508	2	B508	2
Interharmonic Group 21 - Bin 6 phase	03 / 04	0.001°	050A	2	B50A	2
Interharmonic Group 21 - Bin 7 magnitude	03 / 04	0.001% / mV / mA	050C	2	B50C	2
Interharmonic Group 21 - Bin 7 phase	03 / 04	0.001°	050E	2	B50E	2
Interharmonic Group 21 - Bin 8 magnitude	03 / 04	0.001% / mV / mA	0510	2	B510	2
Interharmonic Group 21 - Bin 8 phase	03 / 04	0.001°	0512	2	B512	2
Interharmonic Group 21 - Bin 9 magnitude	03 / 04	0.001% / mV / mA	0514	2	B514	2
Interharmonic Group 21 - Bin 9 phase	03 / 04	0.001°	0516	2	B516	2
Interharmonic Group 21 - Bin 10 magnitude	03 / 04	0.001% / mV / mA	0518	2	B518	2
Interharmonic Group 21 - Bin 10 phase	03 / 04	0.001°	051A	2	B51A	2
Interharmonic Group 21 - Bin 11 magnitude	03 / 04	0.001% / mV / mA	051C	2	B51C	2
Interharmonic Group 21 - Bin 11 phase	03 / 04	0.001°	051E	2	B51E	2
22nd Harmonic Component - Magnitude	03 / 04	0.001% / mV / mA	0520	2	B520	2
22nd Harmonic Component - Phase	03 / 04	0.001°	0522	2	B522	2
Interharmonic Group 22 - Bin 1 magnitude	03 / 04	0.001% / mV / mA	0524	2	B524	2
Interharmonic Group 22 - Bin 1 phase	03 / 04	0.001°	0526	2	B526	2
Interharmonic Group 22 - Bin 2 magnitude	03 / 04	0.001% / mV / mA	0528	2	B528	2
Interharmonic Group 22 - Bin 2 phase	03 / 04	0.001°	052A	2	B52A	2
Interharmonic Group 22 - Bin 3 magnitude	03 / 04	0.001% / mV / mA	052C	2	B52C	2
Interharmonic Group 22 - Bin 3 phase	03 / 04	0.001°	052E	2	B52E	2
Interharmonic Group 22 - Bin 4 magnitude	03 / 04	0.001% / mV / mA	0530	2	B530	2
Interharmonic Group 22 - Bin 4 phase	03 / 04	0.001°	0532	2	B532	2
Interharmonic Group 22 - Bin 5 magnitude	03 / 04	0.001% / mV / mA	0534	2	B534	2
Interharmonic Group 22 - Bin 5 phase	03 / 04	0.001°	0536	2	B536	2
Interharmonic Group 22 - Bin 6 magnitude	03 / 04	0.001% / mV / mA	0538	2	B538	2
Interharmonic Group 22 - Bin 6 phase	03 / 04	0.001°	053A	2	B53A	2
Interharmonic Group 22 - Bin 7 magnitude	03 / 04	0.001% / mV / mA	053C	2	B53C	2
Interharmonic Group 22 - Bin 7 phase	03 / 04	0.001°	053E	2	B53E	2
Interharmonic Group 22 - Bin 8 magnitude	03 / 04	0.001% / mV / mA	0540	2	B540	2
Interharmonic Group 22 - Bin 8 phase	03 / 04	0.001°	0542	2	B542	2
Interharmonic Group 22 - Bin 9 magnitude	03 / 04	0.001% / mV / mA	0544	2	B544	2
Interharmonic Group 22 - Bin 9 phase	03 / 04	0.001°	0546	2	B546	2
Interharmonic Group 21 - Bin 10 magnitude	03 / 04	0.001% / mV / mA	0548	2	B548	2
Interharmonic Group 21 - Bin 10 phase	03 / 04	0.001°	054A	2	B54A	2
Interharmonic Group 21 - Bin 11 magnitude	03 / 04	0.001% / mV / mA	054C	2	B54C	2
Interharmonic Group 21 - Bin 11 phase	03 / 04	0.001°	054E	2	B54E	2
23rd Harmonic Component - Magnitude	03 / 04	0.001% / mV / mA	0550	2	B550	2
23rd Harmonic Component - Phase	03 / 04	0.001°	0552	2	B552	2
Interharmonic Group 23 - Bin 1 magnitude	03 / 04	0.001% / mV / mA	0554	2	B554	2
Interharmonic Group 23 - Bin 1 phase	03 / 04	0.001°	0556	2	B556	2
Interharmonic Group 23 - Bin 2 magnitude	03 / 04	0.001% / mV / mA	0558	2	B558	2
Interharmonic Group 23 - Bin 2 phase	03 / 04	0.001°	055A	2	B55A	2
Interharmonic Group 23 - Bin 3 magnitude	03 / 04	0.001% / mV / mA	055C	2	B55C	2
Interharmonic Group 23 - Bin 3 phase	03 / 04	0.001°	055E	2	B55E	2
Interharmonic Group 23 - Bin 4 magnitude	03 / 04	0.001% / mV / mA	0560	2	B560	2
Interharmonic Group 23 - Bin 4 phase	03 / 04	0.001°	0562	2	B562	2

Parameter	F. code (Hex)	M.U.	INTEGER		IEEE	
			Register (Hex)	Words	Register (Hex)	Words
VOLTAGE & CURRENT HARMONICS & INTERHARMONICS MAGNITUDE&PHASE - f_{nom}=60 Hz						
Interharmonic Group 23 - Bin 5 magnitude	03 / 04	0.001% / mV / mA	0564	2	B564	2
Interharmonic Group 23 - Bin 5 phase	03 / 04	0.001°	0566	2	B566	2
Interharmonic Group 23 - Bin 6 magnitude	03 / 04	0.001% / mV / mA	0568	2	B568	2
Interharmonic Group 23 - Bin 6 phase	03 / 04	0.001°	056A	2	B56A	2
Interharmonic Group 23 - Bin 7 magnitude	03 / 04	0.001% / mV / mA	056C	2	B56C	2
Interharmonic Group 23 - Bin 7 phase	03 / 04	0.001°	056E	2	B56E	2
Interharmonic Group 23 - Bin 8 magnitude	03 / 04	0.001% / mV / mA	0570	2	B570	2
Interharmonic Group 23 - Bin 8 phase	03 / 04	0.001°	0572	2	B572	2
Interharmonic Group 23 - Bin 9 magnitude	03 / 04	0.001% / mV / mA	0574	2	B574	2
Interharmonic Group 23 - Bin 9 phase	03 / 04	0.001°	0576	2	B576	2
Interharmonic Group 23 - Bin 10 magnitude	03 / 04	0.001% / mV / mA	0578	2	B578	2
Interharmonic Group 23 - Bin 10 phase	03 / 04	0.001°	057A	2	B57A	2
Interharmonic Group 23 - Bin 11 magnitude	03 / 04	0.001% / mV / mA	057C	2	B57C	2
Interharmonic Group 23 - Bin 11 phase	03 / 04	0.001°	057E	2	B57E	2
24th Harmonic Component - Magnitude	03 / 04	0.001% / mV / mA	0580	2	B580	2
24th Harmonic Component - Phase	03 / 04	0.001°	0582	2	B582	2
Interharmonic Group 24 - Bin 1 magnitude	03 / 04	0.001% / mV / mA	0584	2	B584	2
Interharmonic Group 24 - Bin 1 phase	03 / 04	0.001°	0586	2	B586	2
Interharmonic Group 24 - Bin 2 magnitude	03 / 04	0.001% / mV / mA	0588	2	B588	2
Interharmonic Group 24 - Bin 2 phase	03 / 04	0.001°	058A	2	B58A	2
Interharmonic Group 24 - Bin 3 magnitude	03 / 04	0.001% / mV / mA	058C	2	B58C	2
Interharmonic Group 24 - Bin 3 phase	03 / 04	0.001°	058E	2	B58E	2
Interharmonic Group 24 - Bin 4 magnitude	03 / 04	0.001% / mV / mA	0590	2	B590	2
Interharmonic Group 24 - Bin 4 phase	03 / 04	0.001°	0592	2	B592	2
Interharmonic Group 24 - Bin 5 magnitude	03 / 04	0.001% / mV / mA	0594	2	B594	2
Interharmonic Group 24 - Bin 5 phase	03 / 04	0.001°	0596	2	B596	2
Interharmonic Group 24 - Bin 6 magnitude	03 / 04	0.001% / mV / mA	0598	2	B598	2
Interharmonic Group 24 - Bin 6 phase	03 / 04	0.001°	059A	2	B59A	2
Interharmonic Group 24 - Bin 7 magnitude	03 / 04	0.001% / mV / mA	059C	2	B59C	2
Interharmonic Group 24 - Bin 7 phase	03 / 04	0.001°	059E	2	B59E	2
Interharmonic Group 24 - Bin 8 magnitude	03 / 04	0.001% / mV / mA	05A0	2	B5A0	2
Interharmonic Group 24 - Bin 8 phase	03 / 04	0.001°	05A2	2	B5A2	2
Interharmonic Group 24 - Bin 9 magnitude	03 / 04	0.001% / mV / mA	05A4	2	B5A4	2
Interharmonic Group 24 - Bin 9 phase	03 / 04	0.001°	05A6	2	B5A6	2
Interharmonic Group 24 - Bin 10 magnitude	03 / 04	0.001% / mV / mA	05A8	2	B5A8	2
Interharmonic Group 24 - Bin 10 phase	03 / 04	0.001°	05AA	2	B5AA	2
Interharmonic Group 24 - Bin 11 magnitude	03 / 04	0.001% / mV / mA	05AC	2	B5AC	2
Interharmonic Group 24 - Bin 11 phase	03 / 04	0.001°	05AE	2	B5AE	2
25th Harmonic Component - Magnitude	03 / 04	0.001% / mV / mA	05B0	2	B5B0	2
25th Harmonic Component - Phase	03 / 04	0.001°	05B2	2	B5B2	2
Interharmonic Group 25 - Bin 1 magnitude	03 / 04	0.001% / mV / mA	05B4	2	B5B4	2
Interharmonic Group 25 - Bin 1 phase	03 / 04	0.001°	05B6	2	B5B6	2
Interharmonic Group 25 - Bin 2 magnitude	03 / 04	0.001% / mV / mA	05B8	2	B5B8	2
Interharmonic Group 25 - Bin 2 phase	03 / 04	0.001°	05BA	2	B5BA	2
Interharmonic Group 25 - Bin 3 magnitude	03 / 04	0.001% / mV / mA	05BC	2	B5BC	2
Interharmonic Group 25 - Bin 3 phase	03 / 04	0.001°	05BE	2	B5BE	2
Interharmonic Group 25 - Bin 4 magnitude	03 / 04	0.001% / mV / mA	05C0	2	B5C0	2
Interharmonic Group 25 - Bin 4 phase	03 / 04	0.001°	05C2	2	B5C2	2
Interharmonic Group 25 - Bin 5 magnitude	03 / 04	0.001% / mV / mA	05C4	2	B5C4	2
Interharmonic Group 25 - Bin 5 phase	03 / 04	0.001°	05C6	2	B5C6	2

Parameter	F. code (Hex)	M.U.	INTEGER		IEEE	
			Register (Hex)	Words	Register (Hex)	Words
VOLTAGE & CURRENT HARMONICS & INTERHARMONICS MAGNITUDE&PHASE - fnom=60 Hz						
Interharmonic Group 25 - Bin 6 magnitude	03 / 04	0.001% / mV / mA	05C8	2	B5C8	2
Interharmonic Group 25 - Bin 6 phase	03 / 04	0.001°	05CA	2	B5CA	2
Interharmonic Group 25 - Bin 7 magnitude	03 / 04	0.001% / mV / mA	05CC	2	B5CC	2
Interharmonic Group 25 - Bin 7 phase	03 / 04	0.001°	05CE	2	B5CE	2
Interharmonic Group 25 - Bin 8 magnitude	03 / 04	0.001% / mV / mA	05D0	2	B5D0	2
Interharmonic Group 25 - Bin 8 phase	03 / 04	0.001°	05D2	2	B5D2	2
Interharmonic Group 25 - Bin 9 magnitude	03 / 04	0.001% / mV / mA	05D4	2	B5D4	2
Interharmonic Group 25 - Bin 9 phase	03 / 04	0.001°	05D6	2	B5D6	2
Interharmonic Group 25 - Bin 10 magnitude	03 / 04	0.001% / mV / mA	05D8	2	B5D8	2
Interharmonic Group 25 - Bin 10 phase	03 / 04	0.001°	05DA	2	B5DA	2
Interharmonic Group 25 - Bin 11 magnitude	03 / 04	0.001% / mV / mA	05DC	2	B5DC	2
Interharmonic Group 25 - Bin 11 phase	03 / 04	0.001°	05DE	2	B5DE	2
26th Harmonic Component - Magnitude	03 / 04	0.001% / mV / mA	05E0	2	B5E0	2
26th Harmonic Component - Phase	03 / 04	0.001°	05E2	2	B5E2	2
Interharmonic Group 26 - Bin 1 magnitude	03 / 04	0.001% / mV / mA	05E4	2	B5E4	2
Interharmonic Group 26 - Bin 1 phase	03 / 04	0.001°	05E6	2	B5E6	2
Interharmonic Group 26 - Bin 2 magnitude	03 / 04	0.001% / mV / mA	05E8	2	B5E8	2
Interharmonic Group 26 - Bin 2 phase	03 / 04	0.001°	05EA	2	B5EA	2
Interharmonic Group 26 - Bin 3 magnitude	03 / 04	0.001% / mV / mA	05EC	2	B5EC	2
Interharmonic Group 26 - Bin 3 phase	03 / 04	0.001°	05EE	2	B5EE	2
Interharmonic Group 26 - Bin 4 magnitude	03 / 04	0.001% / mV / mA	05F0	2	B5F0	2
Interharmonic Group 26 - Bin 4 phase	03 / 04	0.001°	05F2	2	B5F2	2
Interharmonic Group 26 - Bin 5 magnitude	03 / 04	0.001% / mV / mA	05F4	2	B5F4	2
Interharmonic Group 26 - Bin 5 phase	03 / 04	0.001°	05F6	2	B5F6	2
Interharmonic Group 26 - Bin 6 magnitude	03 / 04	0.001% / mV / mA	05F8	2	B5F8	2
Interharmonic Group 26 - Bin 6 phase	03 / 04	0.001°	05FA	2	B5FA	2
Interharmonic Group 26 - Bin 7 magnitude	03 / 04	0.001% / mV / mA	05FC	2	B5FC	2
Interharmonic Group 26 - Bin 7 phase	03 / 04	0.001°	05FE	2	B5FE	2
Interharmonic Group 26 - Bin 8 magnitude	03 / 04	0.001% / mV / mA	0600	2	B600	2
Interharmonic Group 26 - Bin 8 phase	03 / 04	0.001°	0602	2	B602	2
Interharmonic Group 26 - Bin 9 magnitude	03 / 04	0.001% / mV / mA	0604	2	B604	2
Interharmonic Group 26 - Bin 9 phase	03 / 04	0.001°	0606	2	B606	2
Interharmonic Group 26 - Bin 10 magnitude	03 / 04	0.001% / mV / mA	0608	2	B608	2
Interharmonic Group 26 - Bin 10 phase	03 / 04	0.001°	060A	2	B60A	2
Interharmonic Group 26 - Bin 11 magnitude	03 / 04	0.001% / mV / mA	060C	2	B60C	2
Interharmonic Group 26 - Bin 11 phase	03 / 04	0.001°	060E	2	B60E	2
27th Harmonic Component - Magnitude	03 / 04	0.001% / mV / mA	0610	2	B610	2
27th Harmonic Component - Phase	03 / 04	0.001°	0612	2	B612	2
Interharmonic Group 27 - Bin 1 magnitude	03 / 04	0.001% / mV / mA	0614	2	B614	2
Interharmonic Group 27 - Bin 1 phase	03 / 04	0.001°	0616	2	B616	2
Interharmonic Group 27 - Bin 2 magnitude	03 / 04	0.001% / mV / mA	0618	2	B618	2
Interharmonic Group 27 - Bin 2 phase	03 / 04	0.001°	061A	2	B61A	2
Interharmonic Group 27 - Bin 3 magnitude	03 / 04	0.001% / mV / mA	061C	2	B61C	2
Interharmonic Group 27 - Bin 3 phase	03 / 04	0.001°	061E	2	B61E	2
Interharmonic Group 27 - Bin 4 magnitude	03 / 04	0.001% / mV / mA	0620	2	B620	2
Interharmonic Group 27 - Bin 4 phase	03 / 04	0.001°	0622	2	B622	2
Interharmonic Group 27 - Bin 5 magnitude	03 / 04	0.001% / mV / mA	0624	2	B624	2
Interharmonic Group 27 - Bin 5 phase	03 / 04	0.001°	0626	2	B626	2
Interharmonic Group 27 - Bin 6 magnitude	03 / 04	0.001% / mV / mA	0628	2	B628	2
Interharmonic Group 27 - Bin 6 phase	03 / 04	0.001°	062A	2	B62A	2

Parameter	F. code (Hex)	M.U.	INTEGER		IEEE	
			Register (Hex)	Words	Register (Hex)	Words
VOLTAGE & CURRENT HARMONICS & INTERHARMONICS MAGNITUDE&PHASE - fnom=60 Hz						
Interharmonic Group 27 - Bin 7 magnitude	03 / 04	0.001% / mV / mA	062C	2	B62C	2
Interharmonic Group 27 - Bin 7 phase	03 / 04	0.001°	062E	2	B62E	2
Interharmonic Group 27 - Bin 8 magnitude	03 / 04	0.001% / mV / mA	0630	2	B630	2
Interharmonic Group 27 - Bin 8 phase	03 / 04	0.001°	0632	2	B632	2
Interharmonic Group 27 - Bin 9 magnitude	03 / 04	0.001% / mV / mA	0634	2	B634	2
Interharmonic Group 27 - Bin 9 phase	03 / 04	0.001°	0636	2	B636	2
Interharmonic Group 27 - Bin 10 magnitude	03 / 04	0.001% / mV / mA	0638	2	B638	2
Interharmonic Group 27 - Bin 10 phase	03 / 04	0.001°	063A	2	B63A	2
Interharmonic Group 27 - Bin 11 magnitude	03 / 04	0.001% / mV / mA	063C	2	B63C	2
Interharmonic Group 27 - Bin 11 phase	03 / 04	0.001°	063E	2	B63E	2
28th Harmonic Component - Magnitude	03 / 04	0.001% / mV / mA	0640	2	B640	2
28th Harmonic Component - Phase	03 / 04	0.001°	0642	2	B642	2
Interharmonic Group 28 - Bin 1 magnitude	03 / 04	0.001% / mV / mA	0644	2	B644	2
Interharmonic Group 28 - Bin 1 phase	03 / 04	0.001°	0646	2	B646	2
Interharmonic Group 28 - Bin 2 magnitude	03 / 04	0.001% / mV / mA	0648	2	B648	2
Interharmonic Group 28 - Bin 2 phase	03 / 04	0.001°	064A	2	B64A	2
Interharmonic Group 28 - Bin 3 magnitude	03 / 04	0.001% / mV / mA	064C	2	B64C	2
Interharmonic Group 28 - Bin 3 phase	03 / 04	0.001°	064E	2	B64E	2
Interharmonic Group 28 - Bin 4 magnitude	03 / 04	0.001% / mV / mA	0650	2	B650	2
Interharmonic Group 28 - Bin 4 phase	03 / 04	0.001°	0652	2	B652	2
Interharmonic Group 28 - Bin 5 magnitude	03 / 04	0.001% / mV / mA	0654	2	B654	2
Interharmonic Group 28 - Bin 5 phase	03 / 04	0.001°	0656	2	B656	2
Interharmonic Group 28 - Bin 6 magnitude	03 / 04	0.001% / mV / mA	0658	2	B658	2
Interharmonic Group 28 - Bin 6 phase	03 / 04	0.001°	065A	2	B65A	2
Interharmonic Group 28 - Bin 7 magnitude	03 / 04	0.001% / mV / mA	065C	2	B65C	2
Interharmonic Group 28 - Bin 7 phase	03 / 04	0.001°	065E	2	B65E	2
Interharmonic Group 28 - Bin 8 magnitude	03 / 04	0.001% / mV / mA	0660	2	B660	2
Interharmonic Group 28 - Bin 8 phase	03 / 04	0.001°	0662	2	B662	2
Interharmonic Group 28 - Bin 9 magnitude	03 / 04	0.001% / mV / mA	0664	2	B664	2
Interharmonic Group 28 - Bin 9 phase	03 / 04	0.001°	0666	2	B666	2
Interharmonic Group 28 - Bin 10 magnitude	03 / 04	0.001% / mV / mA	0668	2	B668	2
Interharmonic Group 28 - Bin 10 phase	03 / 04	0.001°	066A	2	B66A	2
Interharmonic Group 28 - Bin 11 magnitude	03 / 04	0.001% / mV / mA	066C	2	B66C	2
Interharmonic Group 28 - Bin 11 phase	03 / 04	0.001°	066E	2	B66E	2
29th Harmonic Component - Magnitude	03 / 04	0.001% / mV / mA	0670	2	B670	2
29th Harmonic Component - Phase	03 / 04	0.001°	0672	2	B672	2
Interharmonic Group 29 - Bin 1 magnitude	03 / 04	0.001% / mV / mA	0674	2	B674	2
Interharmonic Group 29 - Bin 1 phase	03 / 04	0.001°	0676	2	B676	2
Interharmonic Group 29 - Bin 2 magnitude	03 / 04	0.001% / mV / mA	0678	2	B678	2
Interharmonic Group 29 - Bin 2 phase	03 / 04	0.001°	067A	2	B67A	2
Interharmonic Group 29 - Bin 3 magnitude	03 / 04	0.001% / mV / mA	067C	2	B67C	2
Interharmonic Group 29 - Bin 3 phase	03 / 04	0.001°	067E	2	B67E	2
Interharmonic Group 29 - Bin 4 magnitude	03 / 04	0.001% / mV / mA	0680	2	B680	2
Interharmonic Group 29 - Bin 4 phase	03 / 04	0.001°	0682	2	B682	2
Interharmonic Group 29 - Bin 5 magnitude	03 / 04	0.001% / mV / mA	0684	2	B684	2
Interharmonic Group 29 - Bin 5 phase	03 / 04	0.001°	0686	2	B686	2
Interharmonic Group 29 - Bin 6 magnitude	03 / 04	0.001% / mV / mA	0688	2	B688	2
Interharmonic Group 29 - Bin 6 phase	03 / 04	0.001°	068A	2	B68A	2
Interharmonic Group 29 - Bin 7 magnitude	03 / 04	0.001% / mV / mA	068C	2	B68C	2
Interharmonic Group 29 - Bin 7 phase	03 / 04	0.001°	068E	2	B68E	2

Parameter	F. code (Hex)	M.U.	INTEGER		IEEE	
			Register (Hex)	Words	Register (Hex)	Words
VOLTAGE & CURRENT HARMONICS & INTERHARMONICS MAGNITUDE&PHASE - fnom=60 Hz						
Interharmonic Group 29 - Bin 8 magnitude	03 / 04	0.001% / mV / mA	0690	2	B690	2
Interharmonic Group 29 - Bin 8 phase	03 / 04	0.001°	0692	2	B692	2
Interharmonic Group 29 - Bin 9 magnitude	03 / 04	0.001% / mV / mA	0694	2	B694	2
Interharmonic Group 29 - Bin 9 phase	03 / 04	0.001°	0696	2	B696	2
Interharmonic Group 29 - Bin 10 magnitude	03 / 04	0.001% / mV / mA	0698	2	B698	2
Interharmonic Group 29 - Bin 10 phase	03 / 04	0.001°	069A	2	B69A	2
Interharmonic Group 29 - Bin 11 magnitude	03 / 04	0.001% / mV / mA	069C	2	B69C	2
Interharmonic Group 29 - Bin 11 phase	03 / 04	0.001°	069E	2	B69E	2
30th Harmonic Component - Magnitude	03 / 04	0.001% / mV / mA	06A0	2	B6A0	2
30th Harmonic Component - Phase	03 / 04	0.001°	06A2	2	B6A2	2
Interharmonic Group 30 - Bin 1 magnitude	03 / 04	0.001% / mV / mA	06A4	2	B6A4	2
Interharmonic Group 30 - Bin 1 phase	03 / 04	0.001°	06A6	2	B6A6	2
Interharmonic Group 30 - Bin 2 magnitude	03 / 04	0.001% / mV / mA	06A8	2	B6A8	2
Interharmonic Group 30 - Bin 2 phase	03 / 04	0.001°	06AA	2	B6AA	2
Interharmonic Group 30 - Bin 3 magnitude	03 / 04	0.001% / mV / mA	06AC	2	B6AC	2
Interharmonic Group 30 - Bin 3 phase	03 / 04	0.001°	06AE	2	B6AE	2
Interharmonic Group 30 - Bin 4 magnitude	03 / 04	0.001% / mV / mA	06B0	2	B6B0	2
Interharmonic Group 30 - Bin 4 phase	03 / 04	0.001°	06B2	2	B6B2	2
Interharmonic Group 30 - Bin 5 magnitude	03 / 04	0.001% / mV / mA	06B4	2	B6B4	2
Interharmonic Group 30 - Bin 5 phase	03 / 04	0.001°	06B6	2	B6B6	2
Interharmonic Group 30 - Bin 6 magnitude	03 / 04	0.001% / mV / mA	06B8	2	B6B8	2
Interharmonic Group 30 - Bin 6 phase	03 / 04	0.001°	06BA	2	B6BA	2
Interharmonic Group 30 - Bin 7 magnitude	03 / 04	0.001% / mV / mA	06BC	2	B6BC	2
Interharmonic Group 30 - Bin 7 phase	03 / 04	0.001°	06BE	2	B6BE	2
Interharmonic Group 30 - Bin 8 magnitude	03 / 04	0.001% / mV / mA	06C0	2	B6C0	2
Interharmonic Group 30 - Bin 8 phase	03 / 04	0.001°	06C2	2	B6C2	2
Interharmonic Group 30 - Bin 9 magnitude	03 / 04	0.001% / mV / mA	06C4	2	B6C4	2
Interharmonic Group 30 - Bin 9 phase	03 / 04	0.001°	06C6	2	B6C6	2
Interharmonic Group 30 - Bin 10 magnitude	03 / 04	0.001% / mV / mA	06C8	2	B6C8	2
Interharmonic Group 30 - Bin 10 phase	03 / 04	0.001°	06CA	2	B6CA	2
Interharmonic Group 30 - Bin 11 magnitude	03 / 04	0.001% / mV / mA	06CC	2	B6CC	2
Interharmonic Group 30 - Bin 11 phase	03 / 04	0.001°	06CE	2	B6CE	2
31st Harmonic Component - Magnitude	03 / 04	0.001% / mV / mA	06D0	2	B6D0	2
31st Harmonic Component - Phase	03 / 04	0.001°	06D2	2	B6D2	2
Interharmonic Group 31 - Bin 1 magnitude	03 / 04	0.001% / mV / mA	06D4	2	B6D4	2
Interharmonic Group 31 - Bin 1 phase	03 / 04	0.001°	06D6	2	B6D6	2
Interharmonic Group 31 - Bin 2 magnitude	03 / 04	0.001% / mV / mA	06D8	2	B6D8	2
Interharmonic Group 31 - Bin 2 phase	03 / 04	0.001°	06DA	2	B6DA	2
Interharmonic Group 31 - Bin 3 magnitude	03 / 04	0.001% / mV / mA	06DC	2	B6DC	2
Interharmonic Group 31 - Bin 3 phase	03 / 04	0.001°	06DE	2	B6DE	2
Interharmonic Group 31 - Bin 4 magnitude	03 / 04	0.001% / mV / mA	06E0	2	B6E0	2
Interharmonic Group 31 - Bin 4 phase	03 / 04	0.001°	06E2	2	B6E2	2
Interharmonic Group 31 - Bin 5 magnitude	03 / 04	0.001% / mV / mA	06E4	2	B6E4	2
Interharmonic Group 31 - Bin 5 phase	03 / 04	0.001°	06E6	2	B6E6	2
Interharmonic Group 31 - Bin 6 magnitude	03 / 04	0.001% / mV / mA	06E8	2	B6E8	2
Interharmonic Group 31 - Bin 6 phase	03 / 04	0.001°	06EA	2	B6EA	2
Interharmonic Group 31 - Bin 7 magnitude	03 / 04	0.001% / mV / mA	06EC	2	B6EC	2
Interharmonic Group 31 - Bin 7 phase	03 / 04	0.001°	06EE	2	B6EE	2
Interharmonic Group 31 - Bin 8 magnitude	03 / 04	0.001% / mV / mA	06F0	2	B6F0	2
Interharmonic Group 31 - Bin 8 phase	03 / 04	0.001°	06F2	2	B6F2	2

Parameter	F. code (Hex)	M.U.	INTEGER		IEEE	
			Register (Hex)	Words	Register (Hex)	Words
VOLTAGE & CURRENT HARMONICS & INTERHARMONICS MAGNITUDE&PHASE - fnom=60 Hz						
Interharmonic Group 31 - Bin 9 magnitude	03 / 04	0.001% / mV / mA	06F4	2	B6F4	2
Interharmonic Group 31 - Bin 9 phase	03 / 04	0.001°	06F6	2	B6F6	2
Interharmonic Group 31 - Bin 10 magnitude	03 / 04	0.001% / mV / mA	06F8	2	B6F8	2
Interharmonic Group 31 - Bin 10 phase	03 / 04	0.001°	06FA	2	B6FA	2
Interharmonic Group 31 - Bin 11 magnitude	03 / 04	0.001% / mV / mA	06FC	2	B6FC	2
Interharmonic Group 31 - Bin 11 phase	03 / 04	0.001°	06FE	2	B6FE	2
32nd Harmonic Component - Magnitude	03 / 04	0.001% / mV / mA	0700	2	B700	2
32nd Harmonic Component - Phase	03 / 04	0.001°	0702	2	B702	2
Interharmonic Group 32 - Bin 1 magnitude	03 / 04	0.001% / mV / mA	0704	2	B704	2
Interharmonic Group 32 - Bin 1 phase	03 / 04	0.001°	0706	2	B706	2
Interharmonic Group 32 - Bin 2 magnitude	03 / 04	0.001% / mV / mA	0708	2	B708	2
Interharmonic Group 32 - Bin 2 phase	03 / 04	0.001°	070A	2	B70A	2
Interharmonic Group 32 - Bin 3 magnitude	03 / 04	0.001% / mV / mA	070C	2	B70C	2
Interharmonic Group 32 - Bin 3 phase	03 / 04	0.001°	070E	2	B70E	2
Interharmonic Group 32 - Bin 4 magnitude	03 / 04	0.001% / mV / mA	0710	2	B710	2
Interharmonic Group 32 - Bin 4 phase	03 / 04	0.001°	0712	2	B712	2
Interharmonic Group 32 - Bin 5 magnitude	03 / 04	0.001% / mV / mA	0714	2	B714	2
Interharmonic Group 32 - Bin 5 phase	03 / 04	0.001°	0716	2	B716	2
Interharmonic Group 32 - Bin 6 magnitude	03 / 04	0.001% / mV / mA	0718	2	B718	2
Interharmonic Group 32 - Bin 6 phase	03 / 04	0.001°	071A	2	B71A	2
Interharmonic Group 32 - Bin 7 magnitude	03 / 04	0.001% / mV / mA	071C	2	B71C	2
Interharmonic Group 32 - Bin 7 phase	03 / 04	0.001°	071E	2	B71E	2
Interharmonic Group 32 - Bin 8 magnitude	03 / 04	0.001% / mV / mA	0720	2	B720	2
Interharmonic Group 32 - Bin 8 phase	03 / 04	0.001°	0722	2	B722	2
Interharmonic Group 32 - Bin 9 magnitude	03 / 04	0.001% / mV / mA	0724	2	B724	2
Interharmonic Group 32 - Bin 9 phase	03 / 04	0.001°	0726	2	B726	2
Interharmonic Group 32 - Bin 10 magnitude	03 / 04	0.001% / mV / mA	0728	2	B728	2
Interharmonic Group 32 - Bin 10 phase	03 / 04	0.001°	072A	2	B72A	2
Interharmonic Group 32 - Bin 11 magnitude	03 / 04	0.001% / mV / mA	072C	2	B72C	2
Interharmonic Group 32 - Bin 11 phase	03 / 04	0.001°	072E	2	B72E	2
33rd Harmonic Component - Magnitude	03 / 04	0.001% / mV / mA	0730	2	B730	2
33rd Harmonic Component - Phase	03 / 04	0.001°	0732	2	B732	2
Interharmonic Group 33 - Bin 1 magnitude	03 / 04	0.001% / mV / mA	0734	2	B734	2
Interharmonic Group 33 - Bin 1 phase	03 / 04	0.001°	0736	2	B736	2
Interharmonic Group 33 - Bin 2 magnitude	03 / 04	0.001% / mV / mA	0738	2	B738	2
Interharmonic Group 33 - Bin 2 phase	03 / 04	0.001°	073A	2	B73A	2
Interharmonic Group 33 - Bin 3 magnitude	03 / 04	0.001% / mV / mA	073C	2	B73C	2
Interharmonic Group 33 - Bin 3 phase	03 / 04	0.001°	073E	2	B73E	2
Interharmonic Group 33 - Bin 4 magnitude	03 / 04	0.001% / mV / mA	0740	2	B740	2
Interharmonic Group 33 - Bin 4 phase	03 / 04	0.001°	0742	2	B742	2
Interharmonic Group 33 - Bin 5 magnitude	03 / 04	0.001% / mV / mA	0744	2	B744	2
Interharmonic Group 33 - Bin 5 phase	03 / 04	0.001°	0746	2	B746	2
Interharmonic Group 33 - Bin 6 magnitude	03 / 04	0.001% / mV / mA	0748	2	B748	2
Interharmonic Group 33 - Bin 6 phase	03 / 04	0.001°	074A	2	B74A	2
Interharmonic Group 33 - Bin 7 magnitude	03 / 04	0.001% / mV / mA	074C	2	B74C	2
Interharmonic Group 33 - Bin 7 phase	03 / 04	0.001°	074E	2	B74E	2
Interharmonic Group 33 - Bin 8 magnitude	03 / 04	0.001% / mV / mA	0750	2	B750	2
Interharmonic Group 33 - Bin 8 phase	03 / 04	0.001°	0752	2	B752	2
Interharmonic Group 33 - Bin 9 magnitude	03 / 04	0.001% / mV / mA	0754	2	B754	2
Interharmonic Group 33 - Bin 9 phase	03 / 04	0.001°	0756	2	B756	2

Parameter	F. code (Hex)	M.U.	INTEGER		IEEE	
			Register (Hex)	Words	Register (Hex)	Words
VOLTAGE & CURRENT HARMONICS & INTERHARMONICS MAGNITUDE&PHASE - fnom=60 Hz						
Interharmonic Group 33 - Bin 10 magnitude	03 / 04	0.001% / mV / mA	0758	2	B758	2
Interharmonic Group 33 - Bin 10 phase	03 / 04	0.001°	075A	2	B75A	2
Interharmonic Group 33 - Bin 11 magnitude	03 / 04	0.001% / mV / mA	075C	2	B75C	2
Interharmonic Group 33 - Bin 11 phase	03 / 04	0.001°	075E	2	B75E	2
34th Harmonic Component - Magnitude	03 / 04	0.001% / mV / mA	0760	2	B760	2
34th Harmonic Component - Phase	03 / 04	0.001°	0762	2	B762	2
Interharmonic Group 34 - Bin 1 magnitude	03 / 04	0.001% / mV / mA	0764	2	B764	2
Interharmonic Group 34 - Bin 1 phase	03 / 04	0.001°	0766	2	B766	2
Interharmonic Group 34 - Bin 2 magnitude	03 / 04	0.001% / mV / mA	0768	2	B768	2
Interharmonic Group 34 - Bin 2 phase	03 / 04	0.001°	076A	2	B76A	2
Interharmonic Group 34 - Bin 3 magnitude	03 / 04	0.001% / mV / mA	076C	2	B76C	2
Interharmonic Group 34 - Bin 3 phase	03 / 04	0.001°	076E	2	B76E	2
Interharmonic Group 34 - Bin 4 magnitude	03 / 04	0.001% / mV / mA	0770	2	B770	2
Interharmonic Group 34 - Bin 4 phase	03 / 04	0.001°	0772	2	B772	2
Interharmonic Group 34 - Bin 5 magnitude	03 / 04	0.001% / mV / mA	0774	2	B774	2
Interharmonic Group 34 - Bin 5 phase	03 / 04	0.001°	0776	2	B776	2
Interharmonic Group 34 - Bin 6 magnitude	03 / 04	0.001% / mV / mA	0778	2	B778	2
Interharmonic Group 34 - Bin 6 phase	03 / 04	0.001°	077A	2	B77A	2
Interharmonic Group 34 - Bin 7 magnitude	03 / 04	0.001% / mV / mA	077C	2	B77C	2
Interharmonic Group 34 - Bin 7 phase	03 / 04	0.001°	077E	2	B77E	2
Interharmonic Group 34 - Bin 8 magnitude	03 / 04	0.001% / mV / mA	0780	2	B780	2
Interharmonic Group 34 - Bin 8 phase	03 / 04	0.001°	0782	2	B782	2
Interharmonic Group 34 - Bin 9 magnitude	03 / 04	0.001% / mV / mA	0784	2	B784	2
Interharmonic Group 34 - Bin 9 phase	03 / 04	0.001°	0786	2	B786	2
Interharmonic Group 34 - Bin 10 magnitude	03 / 04	0.001% / mV / mA	0788	2	B788	2
Interharmonic Group 34 - Bin 10 phase	03 / 04	0.001°	078A	2	B78A	2
Interharmonic Group 34 - Bin 11 magnitude	03 / 04	0.001% / mV / mA	078C	2	B78C	2
Interharmonic Group 34 - Bin 11 phase	03 / 04	0.001°	078E	2	B78E	2
35th Harmonic Component - Magnitude	03 / 04	0.001% / mV / mA	0790	2	B790	2
35th Harmonic Component - Phase	03 / 04	0.001°	0792	2	B792	2
Interharmonic Group 35 - Bin 1 magnitude	03 / 04	0.001% / mV / mA	0794	2	B794	2
Interharmonic Group 35 - Bin 1 phase	03 / 04	0.001°	0796	2	B796	2
Interharmonic Group 35 - Bin 2 magnitude	03 / 04	0.001% / mV / mA	0798	2	B798	2
Interharmonic Group 35 - Bin 2 phase	03 / 04	0.001°	079A	2	B79A	2
Interharmonic Group 35 - Bin 3 magnitude	03 / 04	0.001% / mV / mA	079C	2	B79C	2
Interharmonic Group 35 - Bin 3 phase	03 / 04	0.001°	079E	2	B79E	2
Interharmonic Group 35 - Bin 4 magnitude	03 / 04	0.001% / mV / mA	07A0	2	B7A0	2
Interharmonic Group 35 - Bin 4 phase	03 / 04	0.001°	07A2	2	B7A2	2
Interharmonic Group 35 - Bin 5 magnitude	03 / 04	0.001% / mV / mA	07A4	2	B7A4	2
Interharmonic Group 35 - Bin 5 phase	03 / 04	0.001°	07A6	2	B7A6	2
Interharmonic Group 35 - Bin 6 magnitude	03 / 04	0.001% / mV / mA	07A8	2	B7A8	2
Interharmonic Group 35 - Bin 6 phase	03 / 04	0.001°	07AA	2	B7AA	2
Interharmonic Group 35 - Bin 7 magnitude	03 / 04	0.001% / mV / mA	07AC	2	B7AC	2
Interharmonic Group 35 - Bin 7 phase	03 / 04	0.001°	07AE	2	B7AE	2
Interharmonic Group 35 - Bin 8 magnitude	03 / 04	0.001% / mV / mA	07B0	2	B7B0	2
Interharmonic Group 35 - Bin 8 phase	03 / 04	0.001°	07B2	2	B7B2	2
Interharmonic Group 35 - Bin 9 magnitude	03 / 04	0.001% / mV / mA	07B4	2	B7B4	2
Interharmonic Group 35 - Bin 9 phase	03 / 04	0.001°	07B6	2	B7B6	2
Interharmonic Group 35 - Bin 10 magnitude	03 / 04	0.001% / mV / mA	07B8	2	B7B8	2
Interharmonic Group 35 - Bin 10 phase	03 / 04	0.001°	07BA	2	B7BA	2

Parameter	F. code (Hex)	M.U.	INTEGER		IEEE	
			Register (Hex)	Words	Register (Hex)	Words
VOLTAGE & CURRENT HARMONICS & INTERHARMONICS MAGNITUDE&PHASE - fnom=60 Hz						
Interharmonic Group 35 - Bin 11 magnitude	03 / 04	0.001% / mV / mA	07BC	2	B7BC	2
Interharmonic Group 35 - Bin 11 phase	03 / 04	0.001°	07BE	2	B7BE	2
36th Harmonic Component - Magnitude	03 / 04	0.001% / mV / mA	07C0	2	B7C0	2
36th Harmonic Component - Phase	03 / 04	0.001°	07C2	2	B7C2	2
Interharmonic Group 36 - Bin 1 magnitude	03 / 04	0.001% / mV / mA	07C4	2	B7C4	2
Interharmonic Group 36 - Bin 1 phase	03 / 04	0.001°	07C6	2	B7C6	2
Interharmonic Group 36 - Bin 2 magnitude	03 / 04	0.001% / mV / mA	07C8	2	B7C8	2
Interharmonic Group 36 - Bin 2 phase	03 / 04	0.001°	07CA	2	B7CA	2
Interharmonic Group 36 - Bin 3 magnitude	03 / 04	0.001% / mV / mA	07CC	2	B7CC	2
Interharmonic Group 36 - Bin 3 phase	03 / 04	0.001°	07CE	2	B7CE	2
Interharmonic Group 36 - Bin 4 magnitude	03 / 04	0.001% / mV / mA	07D0	2	B7D0	2
Interharmonic Group 36 - Bin 4 phase	03 / 04	0.001°	07D2	2	B7D2	2
Interharmonic Group 36 - Bin 5 magnitude	03 / 04	0.001% / mV / mA	07D4	2	B7D4	2
Interharmonic Group 36 - Bin 5 phase	03 / 04	0.001°	07D6	2	B7D6	2
Interharmonic Group 36 - Bin 6 magnitude	03 / 04	0.001% / mV / mA	07D8	2	B7D8	2
Interharmonic Group 36 - Bin 6 phase	03 / 04	0.001°	07DA	2	B7DA	2
Interharmonic Group 36 - Bin 7 magnitude	03 / 04	0.001% / mV / mA	07DC	2	B7DC	2
Interharmonic Group 36 - Bin 7 phase	03 / 04	0.001°	07DE	2	B7DE	2
Interharmonic Group 36 - Bin 8 magnitude	03 / 04	0.001% / mV / mA	07E0	2	B7E0	2
Interharmonic Group 36 - Bin 8 phase	03 / 04	0.001°	07E2	2	B7E2	2
Interharmonic Group 36 - Bin 9 magnitude	03 / 04	0.001% / mV / mA	07E4	2	B7E4	2
Interharmonic Group 36 - Bin 9 phase	03 / 04	0.001°	07E6	2	B7E6	2
Interharmonic Group 36 - Bin 10 magnitude	03 / 04	0.001% / mV / mA	07E8	2	B7E8	2
Interharmonic Group 36 - Bin 10 phase	03 / 04	0.001°	07EA	2	B7EA	2
Interharmonic Group 36 - Bin 11 magnitude	03 / 04	0.001% / mV / mA	07EC	2	B7EC	2
Interharmonic Group 36 - Bin 11 phase	03 / 04	0.001°	07EE	2	B7EE	2
37th Harmonic Component - Magnitude	03 / 04	0.001% / mV / mA	07F0	2	B7F0	2
37th Harmonic Component - Phase	03 / 04	0.001°	07F2	2	B7F2	2
Interharmonic Group 37 - Bin 1 magnitude	03 / 04	0.001% / mV / mA	07F4	2	B7F4	2
Interharmonic Group 37 - Bin 1 phase	03 / 04	0.001°	07F6	2	B7F6	2
Interharmonic Group 37 - Bin 2 magnitude	03 / 04	0.001% / mV / mA	07F8	2	B7F8	2
Interharmonic Group 37 - Bin 2 phase	03 / 04	0.001°	07FA	2	B7FA	2
Interharmonic Group 37 - Bin 3 magnitude	03 / 04	0.001% / mV / mA	07FC	2	B7FC	2
Interharmonic Group 37 - Bin 3 phase	03 / 04	0.001°	07FE	2	B7FE	2
Interharmonic Group 37 - Bin 4 magnitude	03 / 04	0.001% / mV / mA	0800	2	B800	2
Interharmonic Group 37 - Bin 4 phase	03 / 04	0.001°	0802	2	B802	2
Interharmonic Group 37 - Bin 5 magnitude	03 / 04	0.001% / mV / mA	0804	2	B804	2
Interharmonic Group 37 - Bin 5 phase	03 / 04	0.001°	0806	2	B806	2
Interharmonic Group 37 - Bin 6 magnitude	03 / 04	0.001% / mV / mA	0808	2	B808	2
Interharmonic Group 37 - Bin 6 phase	03 / 04	0.001°	080A	2	B80A	2
Interharmonic Group 37 - Bin 7 magnitude	03 / 04	0.001% / mV / mA	080C	2	B80C	2
Interharmonic Group 37 - Bin 7 phase	03 / 04	0.001°	080E	2	B80E	2
Interharmonic Group 37 - Bin 8 magnitude	03 / 04	0.001% / mV / mA	0810	2	B810	2
Interharmonic Group 37 - Bin 8 phase	03 / 04	0.001°	0812	2	B812	2
Interharmonic Group 37 - Bin 9 magnitude	03 / 04	0.001% / mV / mA	0814	2	B814	2
Interharmonic Group 37 - Bin 9 phase	03 / 04	0.001°	0816	2	B816	2
Interharmonic Group 37 - Bin 10 magnitude	03 / 04	0.001% / mV / mA	0818	2	B818	2
Interharmonic Group 37 - Bin 10 phase	03 / 04	0.001°	081A	2	B81A	2
Interharmonic Group 37 - Bin 11 magnitude	03 / 04	0.001% / mV / mA	081C	2	B81C	2
Interharmonic Group 37 - Bin 11 phase	03 / 04	0.001°	081E	2	B81E	2

Parameter	F. code (Hex)	M.U.	INTEGER		IEEE	
			Register (Hex)	Words	Register (Hex)	Words
VOLTAGE & CURRENT HARMONICS & INTERHARMONICS MAGNITUDE&PHASE - fnom=60 Hz						
38th Harmonic Component - Magnitude	03 / 04	0.001% / mV / mA	0820	2	B820	2
38th Harmonic Component - Phase	03 / 04	0.001°	0822	2	B822	2
Interharmonic Group 38 - Bin 1 magnitude	03 / 04	0.001% / mV / mA	0824	2	B824	2
Interharmonic Group 38 - Bin 1 phase	03 / 04	0.001°	0826	2	B826	2
Interharmonic Group 38 - Bin 2 magnitude	03 / 04	0.001% / mV / mA	0828	2	B828	2
Interharmonic Group 38 - Bin 2 phase	03 / 04	0.001°	082A	2	B82A	2
Interharmonic Group 38 - Bin 3 magnitude	03 / 04	0.001% / mV / mA	082C	2	B82C	2
Interharmonic Group 38 - Bin 3 phase	03 / 04	0.001°	082E	2	B82E	2
Interharmonic Group 38 - Bin 4 magnitude	03 / 04	0.001% / mV / mA	0830	2	B830	2
Interharmonic Group 38 - Bin 4 phase	03 / 04	0.001°	0832	2	B832	2
Interharmonic Group 38 - Bin 5 magnitude	03 / 04	0.001% / mV / mA	0834	2	B834	2
Interharmonic Group 38 - Bin 5 phase	03 / 04	0.001°	0836	2	B836	2
Interharmonic Group 38 - Bin 6 magnitude	03 / 04	0.001% / mV / mA	0838	2	B838	2
Interharmonic Group 38 - Bin 6 phase	03 / 04	0.001°	083A	2	B83A	2
Interharmonic Group 38 - Bin 7 magnitude	03 / 04	0.001% / mV / mA	083C	2	B83C	2
Interharmonic Group 38 - Bin 7 phase	03 / 04	0.001°	083E	2	B83E	2
Interharmonic Group 38 - Bin 8 magnitude	03 / 04	0.001% / mV / mA	0840	2	B840	2
Interharmonic Group 38 - Bin 8 phase	03 / 04	0.001°	0842	2	B842	2
Interharmonic Group 38 - Bin 9 magnitude	03 / 04	0.001% / mV / mA	0844	2	B844	2
Interharmonic Group 38 - Bin 9 phase	03 / 04	0.001°	0846	2	B846	2
Interharmonic Group 38 - Bin 10 magnitude	03 / 04	0.001% / mV / mA	0848	2	B848	2
Interharmonic Group 38 - Bin 10 phase	03 / 04	0.001°	084A	2	B84A	2
Interharmonic Group 38 - Bin 11 magnitude	03 / 04	0.001% / mV / mA	084C	2	B84C	2
Interharmonic Group 38 - Bin 11 phase	03 / 04	0.001°	084E	2	B84E	2
39th Harmonic Component - Magnitude	03 / 04	0.001% / mV / mA	0850	2	B850	2
39th Harmonic Component - Phase	03 / 04	0.001°	0852	2	B852	2
Interharmonic Group 39 - Bin 1 magnitude	03 / 04	0.001% / mV / mA	0854	2	B854	2
Interharmonic Group 39 - Bin 1 phase	03 / 04	0.001°	0856	2	B856	2
Interharmonic Group 39 - Bin 2 magnitude	03 / 04	0.001% / mV / mA	0858	2	B858	2
Interharmonic Group 39 - Bin 2 phase	03 / 04	0.001°	085A	2	B85A	2
Interharmonic Group 39 - Bin 3 magnitude	03 / 04	0.001% / mV / mA	085C	2	B85C	2
Interharmonic Group 39 - Bin 3 phase	03 / 04	0.001°	085E	2	B85E	2
Interharmonic Group 39 - Bin 4 magnitude	03 / 04	0.001% / mV / mA	0860	2	B860	2
Interharmonic Group 39 - Bin 4 phase	03 / 04	0.001°	0862	2	B862	2
Interharmonic Group 39 - Bin 5 magnitude	03 / 04	0.001% / mV / mA	0864	2	B864	2
Interharmonic Group 39 - Bin 5 phase	03 / 04	0.001°	0866	2	B866	2
Interharmonic Group 39 - Bin 6 magnitude	03 / 04	0.001% / mV / mA	0868	2	B868	2
Interharmonic Group 39 - Bin 6 phase	03 / 04	0.001°	086A	2	B86A	2
Interharmonic Group 39 - Bin 7 magnitude	03 / 04	0.001% / mV / mA	086C	2	B86C	2
Interharmonic Group 39 - Bin 7 phase	03 / 04	0.001°	086E	2	B86E	2
Interharmonic Group 39 - Bin 8 magnitude	03 / 04	0.001% / mV / mA	0870	2	B870	2
Interharmonic Group 39 - Bin 8 phase	03 / 04	0.001°	0872	2	B872	2
Interharmonic Group 39 - Bin 9 magnitude	03 / 04	0.001% / mV / mA	0874	2	B874	2
Interharmonic Group 39 - Bin 9 phase	03 / 04	0.001°	0876	2	B876	2
Interharmonic Group 39 - Bin 10 magnitude	03 / 04	0.001% / mV / mA	0878	2	B878	2
Interharmonic Group 39 - Bin 10 phase	03 / 04	0.001°	087A	2	B87A	2
Interharmonic Group 39 - Bin 11 magnitude	03 / 04	0.001% / mV / mA	087C	2	B87C	2
Interharmonic Group 39 - Bin 11 phase	03 / 04	0.001°	087E	2	B87E	2
40th Harmonic Component - Magnitude	03 / 04	0.001% / mV / mA	0880	2	B880	2
40th Harmonic Component - Phase	03 / 04	0.001°	0882	2	B882	2

Parameter	F. code (Hex)	M.U.	INTEGER		IEEE	
			Register (Hex)	Words	Register (Hex)	Words
VOLTAGE & CURRENT HARMONICS & INTERHARMONICS MAGNITUDE&PHASE - fnom=60 Hz						
Interharmonic Group 40 - Bin 1 magnitude	03 / 04	0.001% / mV / mA	0884	2	B884	2
Interharmonic Group 40 - Bin 1 phase	03 / 04	0.001°	0886	2	B886	2
Interharmonic Group 40 - Bin 2 magnitude	03 / 04	0.001% / mV / mA	0888	2	B888	2
Interharmonic Group 40 - Bin 2 phase	03 / 04	0.001°	088A	2	B88A	2
Interharmonic Group 40 - Bin 3 magnitude	03 / 04	0.001% / mV / mA	088C	2	B88C	2
Interharmonic Group 40 - Bin 3 phase	03 / 04	0.001°	088E	2	B88E	2
Interharmonic Group 40 - Bin 4 magnitude	03 / 04	0.001% / mV / mA	0890	2	B890	2
Interharmonic Group 40 - Bin 4 phase	03 / 04	0.001°	0892	2	B892	2
Interharmonic Group 40 - Bin 5 magnitude	03 / 04	0.001% / mV / mA	0894	2	B894	2
Interharmonic Group 40 - Bin 5 phase	03 / 04	0.001°	0896	2	B896	2
Interharmonic Group 40 - Bin 6 magnitude	03 / 04	0.001% / mV / mA	0898	2	B898	2
Interharmonic Group 40 - Bin 6 phase	03 / 04	0.001°	089A	2	B89A	2
Interharmonic Group 40 - Bin 7 magnitude	03 / 04	0.001% / mV / mA	089C	2	B89C	2
Interharmonic Group 40 - Bin 7 phase	03 / 04	0.001°	089E	2	B89E	2
Interharmonic Group 40 - Bin 8 magnitude	03 / 04	0.001% / mV / mA	08A0	2	B8A0	2
Interharmonic Group 40 - Bin 8 phase	03 / 04	0.001°	08A2	2	B8A2	2
Interharmonic Group 40 - Bin 9 magnitude	03 / 04	0.001% / mV / mA	08A4	2	B8A4	2
Interharmonic Group 40 - Bin 9 phase	03 / 04	0.001°	08A6	2	B8A6	2
Interharmonic Group 40 - Bin 10 magnitude	03 / 04	0.001% / mV / mA	08A8	2	B8A8	2
Interharmonic Group 40 - Bin 10 phase	03 / 04	0.001°	08AA	2	B8AA	2
Interharmonic Group 40 - Bin 11 magnitude	03 / 04	0.001% / mV / mA	08AC	2	B8AC	2
Interharmonic Group 40 - Bin 11 phase	03 / 04	0.001°	08AE	2	B8AE	2
41st Harmonic Component - Magnitude	03 / 04	0.001% / mV / mA	08B0	2	B8B0	2
41st Harmonic Component - Phase	03 / 04	0.001°	08B2	2	B8B2	2
Interharmonic Group 41 - Bin 1 magnitude	03 / 04	0.001% / mV / mA	08B4	2	B8B4	2
Interharmonic Group 41 - Bin 1 phase	03 / 04	0.001°	08B6	2	B8B6	2
Interharmonic Group 41 - Bin 2 magnitude	03 / 04	0.001% / mV / mA	08B8	2	B8B8	2
Interharmonic Group 41 - Bin 2 phase	03 / 04	0.001°	08BA	2	B8BA	2
Interharmonic Group 41 - Bin 3 magnitude	03 / 04	0.001% / mV / mA	08BC	2	B8BC	2
Interharmonic Group 41 - Bin 3 phase	03 / 04	0.001°	08BE	2	B8BE	2
Interharmonic Group 41 - Bin 4 magnitude	03 / 04	0.001% / mV / mA	08C0	2	B8C0	2
Interharmonic Group 41 - Bin 4 phase	03 / 04	0.001°	08C2	2	B8C2	2
Interharmonic Group 41 - Bin 5 magnitude	03 / 04	0.001% / mV / mA	08C4	2	B8C4	2
Interharmonic Group 41 - Bin 5 phase	03 / 04	0.001°	08C6	2	B8C6	2
Interharmonic Group 41 - Bin 6 magnitude	03 / 04	0.001% / mV / mA	08C8	2	B8C8	2
Interharmonic Group 41 - Bin 6 phase	03 / 04	0.001°	08CA	2	B8CA	2
Interharmonic Group 41 - Bin 7 magnitude	03 / 04	0.001% / mV / mA	08CC	2	B8CC	2
Interharmonic Group 41 - Bin 7 phase	03 / 04	0.001°	08CE	2	B8CE	2
Interharmonic Group 41 - Bin 8 magnitude	03 / 04	0.001% / mV / mA	08D0	2	B8D0	2
Interharmonic Group 41 - Bin 8 phase	03 / 04	0.001°	08D2	2	B8D2	2
Interharmonic Group 41 - Bin 9 magnitude	03 / 04	0.001% / mV / mA	08D4	2	B8D4	2
Interharmonic Group 41 - Bin 9 phase	03 / 04	0.001°	08D6	2	B8D6	2
Interharmonic Group 41 - Bin 10 magnitude	03 / 04	0.001% / mV / mA	08D8	2	B8D8	2
Interharmonic Group 41 - Bin 10 phase	03 / 04	0.001°	08DA	2	B8DA	2
Interharmonic Group 41 - Bin 11 magnitude	03 / 04	0.001% / mV / mA	08DC	2	B8DC	2
Interharmonic Group 41 - Bin 11 phase	03 / 04	0.001°	08DE	2	B8DE	2
42nd Harmonic Component - Magnitude	03 / 04	0.001% / mV / mA	08E0	2	B8E0	2
42nd Harmonic Component - Phase	03 / 04	0.001°	08E2	2	B8E2	2
Interharmonic Group 42 - Bin 1 magnitude	03 / 04	0.001% / mV / mA	08E4	2	B8E4	2
Interharmonic Group 42 - Bin 1 phase	03 / 04	0.001°	08E6	2	B8E6	2

Parameter	F. code (Hex)	M.U.	INTEGER		IEEE	
			Register (Hex)	Words	Register (Hex)	Words
VOLTAGE & CURRENT HARMONICS & INTERHARMONICS MAGNITUDE&PHASE - fnom=60 Hz						
Interharmonic Group 42 - Bin 2 magnitude	03 / 04	0.001% / mV / mA	08E8	2	B8E8	2
Interharmonic Group 42 - Bin 2 phase	03 / 04	0.001°	08EA	2	B8EA	2
Interharmonic Group 42 - Bin 3 magnitude	03 / 04	0.001% / mV / mA	08EC	2	B8EC	2
Interharmonic Group 42 - Bin 3 phase	03 / 04	0.001°	08EE	2	B8EE	2
Interharmonic Group 42 - Bin 4 magnitude	03 / 04	0.001% / mV / mA	08F0	2	B8F0	2
Interharmonic Group 42 - Bin 4 phase	03 / 04	0.001°	08F2	2	B8F2	2
Interharmonic Group 42 - Bin 5 magnitude	03 / 04	0.001% / mV / mA	08F4	2	B8F4	2
Interharmonic Group 42 - Bin 5 phase	03 / 04	0.001°	08F6	2	B8F6	2
Interharmonic Group 42 - Bin 6 magnitude	03 / 04	0.001% / mV / mA	08F8	2	B8F8	2
Interharmonic Group 42 - Bin 6 phase	03 / 04	0.001°	08FA	2	B8FA	2
Interharmonic Group 42 - Bin 7 magnitude	03 / 04	0.001% / mV / mA	08FC	2	B8FC	2
Interharmonic Group 42 - Bin 7 phase	03 / 04	0.001°	08FE	2	B8FE	2
Interharmonic Group 42 - Bin 8 magnitude	03 / 04	0.001% / mV / mA	0900	2	B900	2
Interharmonic Group 42 - Bin 8 phase	03 / 04	0.001°	0902	2	B902	2
Interharmonic Group 42 - Bin 9 magnitude	03 / 04	0.001% / mV / mA	0904	2	B904	2
Interharmonic Group 42 - Bin 9 phase	03 / 04	0.001°	0906	2	B906	2
Interharmonic Group 42 - Bin 10 magnitude	03 / 04	0.001% / mV / mA	0908	2	B908	2
Interharmonic Group 42 - Bin 10 phase	03 / 04	0.001°	090A	2	B90A	2
Interharmonic Group 42 - Bin 11 magnitude	03 / 04	0.001% / mV / mA	090C	2	B90C	2
Interharmonic Group 42 - Bin 11 phase	03 / 04	0.001°	090E	2	B90E	2
43rd Harmonic Component - Magnitude	03 / 04	0.001% / mV / mA	0910	2	B910	2
43rd Harmonic Component - Phase	03 / 04	0.001°	0912	2	B912	2
Interharmonic Group 43 - Bin 1 magnitude	03 / 04	0.001% / mV / mA	0914	2	B914	2
Interharmonic Group 43 - Bin 1 phase	03 / 04	0.001°	0916	2	B916	2
Interharmonic Group 43 - Bin 2 magnitude	03 / 04	0.001% / mV / mA	0918	2	B918	2
Interharmonic Group 43 - Bin 2 phase	03 / 04	0.001°	091A	2	B91A	2
Interharmonic Group 43 - Bin 3 magnitude	03 / 04	0.001% / mV / mA	091C	2	B91C	2
Interharmonic Group 43 - Bin 3 phase	03 / 04	0.001°	091E	2	B91E	2
Interharmonic Group 43 - Bin 4 magnitude	03 / 04	0.001% / mV / mA	0920	2	B920	2
Interharmonic Group 43 - Bin 4 phase	03 / 04	0.001°	0922	2	B922	2
Interharmonic Group 43 - Bin 5 magnitude	03 / 04	0.001% / mV / mA	0924	2	B924	2
Interharmonic Group 43 - Bin 5 phase	03 / 04	0.001°	0926	2	B926	2
Interharmonic Group 43 - Bin 6 magnitude	03 / 04	0.001% / mV / mA	0928	2	B928	2
Interharmonic Group 43 - Bin 6 phase	03 / 04	0.001°	092A	2	B92A	2
Interharmonic Group 43 - Bin 7 magnitude	03 / 04	0.001% / mV / mA	092C	2	B92C	2
Interharmonic Group 43 - Bin 7 phase	03 / 04	0.001°	092E	2	B92E	2
Interharmonic Group 43 - Bin 8 magnitude	03 / 04	0.001% / mV / mA	0930	2	B930	2
Interharmonic Group 43 - Bin 8 phase	03 / 04	0.001°	0932	2	B932	2
Interharmonic Group 43 - Bin 9 magnitude	03 / 04	0.001% / mV / mA	0934	2	B934	2
Interharmonic Group 43 - Bin 9 phase	03 / 04	0.001°	0936	2	B936	2
Interharmonic Group 43 - Bin 10 magnitude	03 / 04	0.001% / mV / mA	0938	2	B938	2
Interharmonic Group 43 - Bin 10 phase	03 / 04	0.001°	093A	2	B93A	2
Interharmonic Group 43 - Bin 11 magnitude	03 / 04	0.001% / mV / mA	093C	2	B93C	2
Interharmonic Group 43 - Bin 11 phase	03 / 04	0.001°	093E	2	B93E	2
44th Harmonic Component - Magnitude	03 / 04	0.001% / mV / mA	0940	2	B940	2
44th Harmonic Component - Phase	03 / 04	0.001°	0942	2	B942	2
Interharmonic Group 44 - Bin 1 magnitude	03 / 04	0.001% / mV / mA	0944	2	B944	2
Interharmonic Group 44 - Bin 1 phase	03 / 04	0.001°	0946	2	B946	2
Interharmonic Group 44 - Bin 2 magnitude	03 / 04	0.001% / mV / mA	0948	2	B948	2
Interharmonic Group 44 - Bin 2 phase	03 / 04	0.001°	094A	2	B94A	2

Parameter	F. code (Hex)	M.U.	INTEGER		IEEE	
			Register (Hex)	Words	Register (Hex)	Words
VOLTAGE & CURRENT HARMONICS & INTERHARMONICS MAGNITUDE&PHASE - fnom=60 Hz						
Interharmonic Group 44 - Bin 3 magnitude	03 / 04	0.001% / mV / mA	094C	2	B94C	2
Interharmonic Group 44 - Bin 3 phase	03 / 04	0.001°	094E	2	B94E	2
Interharmonic Group 44 - Bin 4 magnitude	03 / 04	0.001% / mV / mA	0950	2	B950	2
Interharmonic Group 44 - Bin 4 phase	03 / 04	0.001°	0952	2	B952	2
Interharmonic Group 44 - Bin 5 magnitude	03 / 04	0.001% / mV / mA	0954	2	B954	2
Interharmonic Group 44 - Bin 5 phase	03 / 04	0.001°	0956	2	B956	2
Interharmonic Group 44 - Bin 6 magnitude	03 / 04	0.001% / mV / mA	0958	2	B958	2
Interharmonic Group 44 - Bin 6 phase	03 / 04	0.001°	095A	2	B95A	2
Interharmonic Group 44 - Bin 7 magnitude	03 / 04	0.001% / mV / mA	095C	2	B95C	2
Interharmonic Group 44 - Bin 7 phase	03 / 04	0.001°	095E	2	B95E	2
Interharmonic Group 44 - Bin 8 magnitude	03 / 04	0.001% / mV / mA	0960	2	B960	2
Interharmonic Group 44 - Bin 8 phase	03 / 04	0.001°	0962	2	B962	2
Interharmonic Group 44 - Bin 9 magnitude	03 / 04	0.001% / mV / mA	0964	2	B964	2
Interharmonic Group 44 - Bin 9 phase	03 / 04	0.001°	0966	2	B966	2
Interharmonic Group 44 - Bin 10 magnitude	03 / 04	0.001% / mV / mA	0968	2	B968	2
Interharmonic Group 44 - Bin 10 phase	03 / 04	0.001°	096A	2	B96A	2
Interharmonic Group 44 - Bin 11 magnitude	03 / 04	0.001% / mV / mA	096C	2	B96C	2
Interharmonic Group 44 - Bin 11 phase	03 / 04	0.001°	096E	2	B96E	2
45th Harmonic Component - Magnitude	03 / 04	0.001% / mV / mA	0970	2	B970	2
45th Harmonic Component - Phase	03 / 04	0.001°	0972	2	B972	2
Interharmonic Group 45 - Bin 1 magnitude	03 / 04	0.001% / mV / mA	0974	2	B974	2
Interharmonic Group 45 - Bin 1 phase	03 / 04	0.001°	0976	2	B976	2
Interharmonic Group 45 - Bin 2 magnitude	03 / 04	0.001% / mV / mA	0978	2	B978	2
Interharmonic Group 45 - Bin 2 phase	03 / 04	0.001°	097A	2	B97A	2
Interharmonic Group 45 - Bin 3 magnitude	03 / 04	0.001% / mV / mA	097C	2	B97C	2
Interharmonic Group 45 - Bin 3 phase	03 / 04	0.001°	097E	2	B97E	2
Interharmonic Group 45 - Bin 4 magnitude	03 / 04	0.001% / mV / mA	0980	2	B980	2
Interharmonic Group 45 - Bin 4 phase	03 / 04	0.001°	0982	2	B982	2
Interharmonic Group 45 - Bin 5 magnitude	03 / 04	0.001% / mV / mA	0984	2	B984	2
Interharmonic Group 45 - Bin 5 phase	03 / 04	0.001°	0986	2	B986	2
Interharmonic Group 45 - Bin 6 magnitude	03 / 04	0.001% / mV / mA	0988	2	B988	2
Interharmonic Group 45 - Bin 6 phase	03 / 04	0.001°	098A	2	B98A	2
Interharmonic Group 45 - Bin 7 magnitude	03 / 04	0.001% / mV / mA	098C	2	B98C	2
Interharmonic Group 45 - Bin 7 phase	03 / 04	0.001°	098E	2	B98E	2
Interharmonic Group 45 - Bin 8 magnitude	03 / 04	0.001% / mV / mA	0990	2	B990	2
Interharmonic Group 45 - Bin 8 phase	03 / 04	0.001°	0992	2	B992	2
Interharmonic Group 45 - Bin 9 magnitude	03 / 04	0.001% / mV / mA	0994	2	B994	2
Interharmonic Group 45 - Bin 9 phase	03 / 04	0.001°	0996	2	B996	2
Interharmonic Group 45 - Bin 10 magnitude	03 / 04	0.001% / mV / mA	0998	2	B998	2
Interharmonic Group 45 - Bin 10 phase	03 / 04	0.001°	099A	2	B99A	2
Interharmonic Group 45 - Bin 11 magnitude	03 / 04	0.001% / mV / mA	099C	2	B99C	2
Interharmonic Group 45 - Bin 11 phase	03 / 04	0.001°	099E	2	B99E	2
46th Harmonic Component - Magnitude	03 / 04	0.001% / mV / mA	09A0	2	B9A0	2
46th Harmonic Component - Phase	03 / 04	0.001°	09A2	2	B9A2	2
Interharmonic Group 46 - Bin 1 magnitude	03 / 04	0.001% / mV / mA	09A4	2	B9A4	2
Interharmonic Group 46 - Bin 1 phase	03 / 04	0.001°	09A6	2	B9A6	2
Interharmonic Group 46 - Bin 2 magnitude	03 / 04	0.001% / mV / mA	09A8	2	B9A8	2
Interharmonic Group 46 - Bin 2 phase	03 / 04	0.001°	09AA	2	B9AA	2
Interharmonic Group 46 - Bin 3 magnitude	03 / 04	0.001% / mV / mA	09AC	2	B9AC	2
Interharmonic Group 46 - Bin 3 phase	03 / 04	0.001°	09AE	2	B9AE	2

Parameter	F. code (Hex)	M.U.	INTEGER		IEEE	
			Register (Hex)	Words	Register (Hex)	Words
VOLTAGE & CURRENT HARMONICS & INTERHARMONICS MAGNITUDE&PHASE - fnom=60 Hz						
Interharmonic Group 46 - Bin 4 magnitude	03 / 04	0.001% / mV / mA	09B0	2	B9B0	2
Interharmonic Group 46 - Bin 4 phase	03 / 04	0.001°	09B2	2	B9B2	2
Interharmonic Group 46 - Bin 5 magnitude	03 / 04	0.001% / mV / mA	09B4	2	B9B4	2
Interharmonic Group 46 - Bin 5 phase	03 / 04	0.001°	09B6	2	B9B6	2
Interharmonic Group 46 - Bin 6 magnitude	03 / 04	0.001% / mV / mA	09B8	2	B9B8	2
Interharmonic Group 46 - Bin 6 phase	03 / 04	0.001°	09BA	2	B9BA	2
Interharmonic Group 46 - Bin 7 magnitude	03 / 04	0.001% / mV / mA	09BC	2	B9BC	2
Interharmonic Group 46 - Bin 7 phase	03 / 04	0.001°	09BE	2	B9BE	2
Interharmonic Group 46 - Bin 8 magnitude	03 / 04	0.001% / mV / mA	09C0	2	B9C0	2
Interharmonic Group 46 - Bin 8 phase	03 / 04	0.001°	09C2	2	B9C2	2
Interharmonic Group 46 - Bin 9 magnitude	03 / 04	0.001% / mV / mA	09C4	2	B9C4	2
Interharmonic Group 46 - Bin 9 phase	03 / 04	0.001°	09C6	2	B9C6	2
Interharmonic Group 46 - Bin 10 magnitude	03 / 04	0.001% / mV / mA	09C8	2	B9C8	2
Interharmonic Group 46 - Bin 10 phase	03 / 04	0.001°	09CA	2	B9CA	2
Interharmonic Group 46 - Bin 11 magnitude	03 / 04	0.001% / mV / mA	09CC	2	B9CC	2
Interharmonic Group 46 - Bin 11 phase	03 / 04	0.001°	09CE	2	B9CE	2
47th Harmonic Component - Magnitude	03 / 04	0.001% / mV / mA	09D0	2	B9D0	2
47th Harmonic Component - Phase	03 / 04	0.001°	09D2	2	B9D2	2
Interharmonic Group 47 - Bin 1 magnitude	03 / 04	0.001% / mV / mA	09D4	2	B9D4	2
Interharmonic Group 47 - Bin 1 phase	03 / 04	0.001°	09D6	2	B9D6	2
Interharmonic Group 47 - Bin 2 magnitude	03 / 04	0.001% / mV / mA	09D8	2	B9D8	2
Interharmonic Group 47 - Bin 2 phase	03 / 04	0.001°	09DA	2	B9DA	2
Interharmonic Group 47 - Bin 3 magnitude	03 / 04	0.001% / mV / mA	09DC	2	B9DC	2
Interharmonic Group 47 - Bin 3 phase	03 / 04	0.001°	09DE	2	B9DE	2
Interharmonic Group 47 - Bin 4 magnitude	03 / 04	0.001% / mV / mA	09E0	2	B9E0	2
Interharmonic Group 47 - Bin 4 phase	03 / 04	0.001°	09E2	2	B9E2	2
Interharmonic Group 47 - Bin 5 magnitude	03 / 04	0.001% / mV / mA	09E4	2	B9E4	2
Interharmonic Group 47 - Bin 5 phase	03 / 04	0.001°	09E6	2	B9E6	2
Interharmonic Group 47 - Bin 6 magnitude	03 / 04	0.001% / mV / mA	09E8	2	B9E8	2
Interharmonic Group 47 - Bin 6 phase	03 / 04	0.001°	09EA	2	B9EA	2
Interharmonic Group 47 - Bin 7 magnitude	03 / 04	0.001% / mV / mA	09EC	2	B9EC	2
Interharmonic Group 47 - Bin 7 phase	03 / 04	0.001°	09EE	2	B9EE	2
Interharmonic Group 47 - Bin 8 magnitude	03 / 04	0.001% / mV / mA	09F0	2	B9F0	2
Interharmonic Group 47 - Bin 8 phase	03 / 04	0.001°	09F2	2	B9F2	2
Interharmonic Group 47 - Bin 9 magnitude	03 / 04	0.001% / mV / mA	09F4	2	B9F4	2
Interharmonic Group 47 - Bin 9 phase	03 / 04	0.001°	09F6	2	B9F6	2
Interharmonic Group 47 - Bin 10 magnitude	03 / 04	0.001% / mV / mA	09F8	2	B9F8	2
Interharmonic Group 47 - Bin 10 phase	03 / 04	0.001°	09FA	2	B9FA	2
Interharmonic Group 47 - Bin 11 magnitude	03 / 04	0.001% / mV / mA	09FC	2	B9FC	2
Interharmonic Group 47 - Bin 11 phase	03 / 04	0.001°	09FE	2	B9FE	2
48th Harmonic Component - Magnitude	03 / 04	0.001% / mV / mA	0A00	2	BA00	2
48th Harmonic Component - Phase	03 / 04	0.001°	0A02	2	BA02	2
Interharmonic Group 48 - Bin 1 magnitude	03 / 04	0.001% / mV / mA	0A04	2	BA04	2
Interharmonic Group 48 - Bin 1 phase	03 / 04	0.001°	0A06	2	BA06	2
Interharmonic Group 48 - Bin 2 magnitude	03 / 04	0.001% / mV / mA	0A08	2	BA08	2
Interharmonic Group 48 - Bin 2 phase	03 / 04	0.001°	0A0A	2	BA0A	2
Interharmonic Group 48 - Bin 3 magnitude	03 / 04	0.001% / mV / mA	0A0C	2	BA0C	2
Interharmonic Group 48 - Bin 3 phase	03 / 04	0.001°	0A0E	2	BA0E	2
Interharmonic Group 48 - Bin 4 magnitude	03 / 04	0.001% / mV / mA	0A10	2	BA10	2
Interharmonic Group 48 - Bin 4 phase	03 / 04	0.001°	0A12	2	BA12	2

Parameter	F. code (Hex)	M.U.	INTEGER		IEEE	
			Register (Hex)	Words	Register (Hex)	Words
VOLTAGE & CURRENT HARMONICS & INTERHARMONICS MAGNITUDE&PHASE - fnom=60 Hz						
Interharmonic Group 48 - Bin 5 magnitude	03 / 04	0.001% / mV / mA	0A14	2	BA14	2
Interharmonic Group 48 - Bin 5 phase	03 / 04	0.001°	0A16	2	BA16	2
Interharmonic Group 48 - Bin 6 magnitude	03 / 04	0.001% / mV / mA	0A18	2	BA18	2
Interharmonic Group 48 - Bin 6 phase	03 / 04	0.001°	0A1A	2	BA1A	2
Interharmonic Group 48 - Bin 7 magnitude	03 / 04	0.001% / mV / mA	0A1C	2	BA1C	2
Interharmonic Group 48 - Bin 7 phase	03 / 04	0.001°	0A1E	2	BA1E	2
Interharmonic Group 48 - Bin 8 magnitude	03 / 04	0.001% / mV / mA	0A20	2	BA20	2
Interharmonic Group 48 - Bin 8 phase	03 / 04	0.001°	0A22	2	BA22	2
Interharmonic Group 48 - Bin 9 magnitude	03 / 04	0.001% / mV / mA	0A24	2	BA24	2
Interharmonic Group 48 - Bin 9 phase	03 / 04	0.001°	0A26	2	BA26	2
Interharmonic Group 48 - Bin 10 magnitude	03 / 04	0.001% / mV / mA	0A28	2	BA28	2
Interharmonic Group 48 - Bin 10 phase	03 / 04	0.001°	0A2A	2	BA2A	2
Interharmonic Group 48 - Bin 11 magnitude	03 / 04	0.001% / mV / mA	0A2C	2	BA2C	2
Interharmonic Group 48 - Bin 11 phase	03 / 04	0.001°	0A2E	2	BA2E	2
49th Harmonic Component - Magnitude	03 / 04	0.001% / mV / mA	0A30	2	BA30	2
49th Harmonic Component - Phase	03 / 04	0.001°	0A32	2	BA32	2
Interharmonic Group 49 - Bin 1 magnitude	03 / 04	0.001% / mV / mA	0A34	2	BA34	2
Interharmonic Group 49 - Bin 1 phase	03 / 04	0.001°	0A36	2	BA36	2
Interharmonic Group 49 - Bin 2 magnitude	03 / 04	0.001% / mV / mA	0A38	2	BA38	2
Interharmonic Group 49 - Bin 2 phase	03 / 04	0.001°	0A3A	2	BA3A	2
Interharmonic Group 49 - Bin 3 magnitude	03 / 04	0.001% / mV / mA	0A3C	2	BA3C	2
Interharmonic Group 49 - Bin 3 phase	03 / 04	0.001°	0A3E	2	BA3E	2
Interharmonic Group 49 - Bin 4 magnitude	03 / 04	0.001% / mV / mA	0A40	2	BA40	2
Interharmonic Group 49 - Bin 4 phase	03 / 04	0.001°	0A42	2	BA42	2
Interharmonic Group 49 - Bin 5 magnitude	03 / 04	0.001% / mV / mA	0A44	2	BA44	2
Interharmonic Group 49 - Bin 5 phase	03 / 04	0.001°	0A46	2	BA46	2
Interharmonic Group 49 - Bin 6 magnitude	03 / 04	0.001% / mV / mA	0A48	2	BA48	2
Interharmonic Group 49 - Bin 6 phase	03 / 04	0.001°	0A4A	2	BA4A	2
Interharmonic Group 49 - Bin 7 magnitude	03 / 04	0.001% / mV / mA	0A4C	2	BA4C	2
Interharmonic Group 49 - Bin 7 phase	03 / 04	0.001°	0A4E	2	BA4E	2
Interharmonic Group 49 - Bin 8 magnitude	03 / 04	0.001% / mV / mA	0A50	2	BA50	2
Interharmonic Group 49 - Bin 8 phase	03 / 04	0.001°	0A52	2	BA52	2
Interharmonic Group 49 - Bin 9 magnitude	03 / 04	0.001% / mV / mA	0A54	2	BA54	2
Interharmonic Group 49 - Bin 9 phase	03 / 04	0.001°	0A56	2	BA56	2
Interharmonic Group 49 - Bin 10 magnitude	03 / 04	0.001% / mV / mA	0A58	2	BA58	2
Interharmonic Group 49 - Bin 10 phase	03 / 04	0.001°	0A5A	2	BA5A	2
Interharmonic Group 49 - Bin 11 magnitude	03 / 04	0.001% / mV / mA	0A5C	2	BA5C	2
Interharmonic Group 49 - Bin 11 phase	03 / 04	0.001°	0A5E	2	BA5E	2
50th Harmonic Component - Magnitude	03 / 04	0.001% / mV / mA	0A60	2	BA60	2
50th Harmonic Component - Phase	03 / 04	0.001°	0A62	2	BA62	2
Interharmonic Group 50 - Bin 1 magnitude	03 / 04	0.001% / mV / mA	0A64	2	BA64	2
Interharmonic Group 50 - Bin 1 phase	03 / 04	0.001°	0A66	2	BA66	2
Interharmonic Group 50 - Bin 2 magnitude	03 / 04	0.001% / mV / mA	0A68	2	BA68	2
Interharmonic Group 50 - Bin 2 phase	03 / 04	0.001°	0A6A	2	BA6A	2
Interharmonic Group 50 - Bin 3 magnitude	03 / 04	0.001% / mV / mA	0A6C	2	BA6C	2
Interharmonic Group 50 - Bin 3 phase	03 / 04	0.001°	0A6E	2	BA6E	2
Interharmonic Group 50 - Bin 4 magnitude	03 / 04	0.001% / mV / mA	0A70	2	BA70	2
Interharmonic Group 50 - Bin 4 phase	03 / 04	0.001°	0A72	2	BA72	2
Interharmonic Group 50 - Bin 5 magnitude	03 / 04	0.001% / mV / mA	0A74	2	BA74	2
Interharmonic Group 50 - Bin 5 phase	03 / 04	0.001°	0A76	2	BA76	2

Parameter	F. code (Hex)	M.U.	INTEGER		IEEE	
			Register (Hex)	Words	Register (Hex)	Words
VOLTAGE & CURRENT HARMONICS & INTERHARMONICS MAGNITUDE&PHASE - fnom=60 Hz						
Interharmonic Group 50 - Bin 6 magnitude	03 / 04	0.001% / mV / mA	0A78	2	BA78	2
Interharmonic Group 50 - Bin 6 phase	03 / 04	0.001°	0A7A	2	BA7A	2
Interharmonic Group 50 - Bin 7 magnitude	03 / 04	0.001% / mV / mA	0A7C	2	BA7C	2
Interharmonic Group 50 - Bin 7 phase	03 / 04	0.001°	0A7E	2	BA7E	2
Interharmonic Group 50 - Bin 8 magnitude	03 / 04	0.001% / mV / mA	0A80	2	BA80	2
Interharmonic Group 50 - Bin 8 phase	03 / 04	0.001°	0A82	2	BA82	2
Interharmonic Group 50 - Bin 9 magnitude	03 / 04	0.001% / mV / mA	0A84	2	BA84	2
Interharmonic Group 50 - Bin 9 phase	03 / 04	0.001°	0A86	2	BA86	2
Interharmonic Group 50 - Bin 10 magnitude	03 / 04	0.001% / mV / mA	0A88	2	BA88	2
Interharmonic Group 50 - Bin 10 phase	03 / 04	0.001°	0A8A	2	BA8A	2
Interharmonic Group 50 - Bin 11 magnitude	03 / 04	0.001% / mV / mA	0A8C	2	BA8C	2
Interharmonic Group 50 - Bin 11 phase	03 / 04	0.001°	0A8E	2	BA8E	2
51st Harmonic Component - Magnitude	03 / 04	0.001% / mV / mA	0A90	2	BA90	2
51st Harmonic Component - Phase	03 / 04	0.001°	0A92	2	BA92	2
Interharmonic Group 51 - Bin 1 magnitude	03 / 04	0.001% / mV / mA	0A94	2	BA94	2
Interharmonic Group 51 - Bin 1 phase	03 / 04	0.001°	0A96	2	BA96	2
Interharmonic Group 51 - Bin 2 magnitude	03 / 04	0.001% / mV / mA	0A98	2	BA98	2
Interharmonic Group 51 - Bin 2 phase	03 / 04	0.001°	0A9A	2	BA9A	2
Interharmonic Group 51 - Bin 3 magnitude	03 / 04	0.001% / mV / mA	0A9C	2	BA9C	2
Interharmonic Group 51 - Bin 3 phase	03 / 04	0.001°	0A9E	2	BA9E	2
Interharmonic Group 51 - Bin 4 magnitude	03 / 04	0.001% / mV / mA	0AA0	2	BAA0	2
Interharmonic Group 51 - Bin 4 phase	03 / 04	0.001°	0AA2	2	BAA2	2
Interharmonic Group 51 - Bin 5 magnitude	03 / 04	0.001% / mV / mA	0AA4	2	BAA4	2
Interharmonic Group 51 - Bin 5 phase	03 / 04	0.001°	0AA6	2	BAA6	2
Interharmonic Group 51 - Bin 6 magnitude	03 / 04	0.001% / mV / mA	0AA8	2	BAA8	2
Interharmonic Group 51 - Bin 6 phase	03 / 04	0.001°	0AAA	2	BAAA	2
Interharmonic Group 51 - Bin 7 magnitude	03 / 04	0.001% / mV / mA	0AAC	2	BAAC	2
Interharmonic Group 51 - Bin 7 phase	03 / 04	0.001°	0AAE	2	BAAE	2
Interharmonic Group 51 - Bin 8 magnitude	03 / 04	0.001% / mV / mA	0AB0	2	BAB0	2
Interharmonic Group 51 - Bin 8 phase	03 / 04	0.001°	0AB2	2	BAB2	2
Interharmonic Group 51 - Bin 9 magnitude	03 / 04	0.001% / mV / mA	0AB4	2	BAB4	2
Interharmonic Group 51 - Bin 9 phase	03 / 04	0.001°	0AB6	2	BAB6	2
Interharmonic Group 51 - Bin 10 magnitude	03 / 04	0.001% / mV / mA	0AB8	2	BAB8	2
Interharmonic Group 51 - Bin 10 phase	03 / 04	0.001°	0ABA	2	BABA	2
Interharmonic Group 51 - Bin 11 magnitude	03 / 04	0.001% / mV / mA	0ABC	2	BABC	2
Interharmonic Group 51 - Bin 11 phase	03 / 04	0.001°	0ABE	2	BABE	2
52nd Harmonic Component - Magnitude	03 / 04	0.001% / mV / mA	0AC0	2	BAC0	2
52nd Harmonic Component - Phase	03 / 04	0.001°	0AC2	2	BAC2	2
Interharmonic Group 52 - Bin 1 magnitude	03 / 04	0.001% / mV / mA	0AC4	2	BAC4	2
Interharmonic Group 52 - Bin 1 phase	03 / 04	0.001°	0AC6	2	BAC6	2
Interharmonic Group 52 - Bin 2 magnitude	03 / 04	0.001% / mV / mA	0AC8	2	BAC8	2
Interharmonic Group 52 - Bin 2 phase	03 / 04	0.001°	0ACA	2	BACA	2
Interharmonic Group 52 - Bin 3 magnitude	03 / 04	0.001% / mV / mA	0ACC	2	BACC	2
Interharmonic Group 52 - Bin 3 phase	03 / 04	0.001°	0ACE	2	BACE	2
Interharmonic Group 52 - Bin 4 magnitude	03 / 04	0.001% / mV / mA	0AD0	2	BAD0	2
Interharmonic Group 52 - Bin 4 phase	03 / 04	0.001°	0AD2	2	BAD2	2
Interharmonic Group 52 - Bin 5 magnitude	03 / 04	0.001% / mV / mA	0AD4	2	BAD4	2
Interharmonic Group 52 - Bin 5 phase	03 / 04	0.001°	0AD6	2	BAD6	2
Interharmonic Group 52 - Bin 6 magnitude	03 / 04	0.001% / mV / mA	0AD8	2	BAD8	2
Interharmonic Group 52 - Bin 6 phase	03 / 04	0.001°	0ADA	2	BADA	2

Parameter	F. code (Hex)	M.U.	INTEGER		IEEE	
			Register (Hex)	Words	Register (Hex)	Words
VOLTAGE & CURRENT HARMONICS & INTERHARMONICS MAGNITUDE&PHASE - fnom=60 Hz						
Interharmonic Group 52 - Bin 7 magnitude	03 / 04	0.001% / mV / mA	0ADC	2	BADC	2
Interharmonic Group 52 - Bin 7 phase	03 / 04	0.001°	0ADE	2	BADE	2
Interharmonic Group 52 - Bin 8 magnitude	03 / 04	0.001% / mV / mA	0AE0	2	BAE0	2
Interharmonic Group 52 - Bin 8 phase	03 / 04	0.001°	0AE2	2	BAE2	2
Interharmonic Group 52 - Bin 9 magnitude	03 / 04	0.001% / mV / mA	0AE4	2	BAE4	2
Interharmonic Group 52 - Bin 9 phase	03 / 04	0.001°	0AE6	2	BAE6	2
Interharmonic Group 52 - Bin 10 magnitude	03 / 04	0.001% / mV / mA	0AE8	2	BAE8	2
Interharmonic Group 52 - Bin 10 phase	03 / 04	0.001°	0AEA	2	BAEA	2
Interharmonic Group 52 - Bin 11 magnitude	03 / 04	0.001% / mV / mA	0AEC	2	BAEC	2
Interharmonic Group 52 - Bin 11 phase	03 / 04	0.001°	0AEE	2	BAEE	2
53rd Harmonic Component - Magnitude	03 / 04	0.001% / mV / mA	0AF0	2	BAF0	2
53rd Harmonic Component - Phase	03 / 04	0.001°	0AF2	2	BAF2	2
Interharmonic Group 53 - Bin 1 magnitude	03 / 04	0.001% / mV / mA	0AF4	2	BAF4	2
Interharmonic Group 53 - Bin 1 phase	03 / 04	0.001°	0AF6	2	BAF6	2
Interharmonic Group 53 - Bin 2 magnitude	03 / 04	0.001% / mV / mA	0AF8	2	BAF8	2
Interharmonic Group 53 - Bin 2 phase	03 / 04	0.001°	0AFA	2	BAFA	2
Interharmonic Group 53 - Bin 3 magnitude	03 / 04	0.001% / mV / mA	0AFC	2	BAFC	2
Interharmonic Group 53 - Bin 3 phase	03 / 04	0.001°	0AFE	2	BAFE	2
Interharmonic Group 53 - Bin 4 magnitude	03 / 04	0.001% / mV / mA	0B00	2	BB00	2
Interharmonic Group 53 - Bin 4 phase	03 / 04	0.001°	0B02	2	BB02	2
Interharmonic Group 53 - Bin 5 magnitude	03 / 04	0.001% / mV / mA	0B04	2	BB04	2
Interharmonic Group 53 - Bin 5 phase	03 / 04	0.001°	0B06	2	BB06	2
Interharmonic Group 53 - Bin 6 magnitude	03 / 04	0.001% / mV / mA	0B08	2	BB08	2
Interharmonic Group 53 - Bin 6 phase	03 / 04	0.001°	0B0A	2	BB0A	2
Interharmonic Group 53 - Bin 7 magnitude	03 / 04	0.001% / mV / mA	0B0C	2	BB0C	2
Interharmonic Group 53 - Bin 7 phase	03 / 04	0.001°	0B0E	2	BB0E	2
Interharmonic Group 53 - Bin 8 magnitude	03 / 04	0.001% / mV / mA	0B10	2	BB10	2
Interharmonic Group 53 - Bin 8 phase	03 / 04	0.001°	0B12	2	BB12	2
Interharmonic Group 53 - Bin 9 magnitude	03 / 04	0.001% / mV / mA	0B14	2	BB14	2
Interharmonic Group 53 - Bin 9 phase	03 / 04	0.001°	0B16	2	BB16	2
Interharmonic Group 53 - Bin 10 magnitude	03 / 04	0.001% / mV / mA	0B18	2	BB18	2
Interharmonic Group 53 - Bin 10 phase	03 / 04	0.001°	0B1A	2	BB1A	2
Interharmonic Group 53 - Bin 11 magnitude	03 / 04	0.001% / mV / mA	0B1C	2	BB1C	2
Interharmonic Group 53 - Bin 11 phase	03 / 04	0.001°	0B1E	2	BB1E	2
54th Harmonic Component - Magnitude	03 / 04	0.001% / mV / mA	0B20	2	BB20	2
54th Harmonic Component - Phase	03 / 04	0.001°	0B22	2	BB22	2
Interharmonic Group 54 - Bin 1 magnitude	03 / 04	0.001% / mV / mA	0B24	2	BB24	2
Interharmonic Group 54 - Bin 1 phase	03 / 04	0.001°	0B26	2	BB26	2
Interharmonic Group 54 - Bin 2 magnitude	03 / 04	0.001% / mV / mA	0B28	2	BB28	2
Interharmonic Group 54 - Bin 2 phase	03 / 04	0.001°	0B2A	2	BB2A	2
Interharmonic Group 54 - Bin 3 magnitude	03 / 04	0.001% / mV / mA	0B2C	2	BB2C	2
Interharmonic Group 54 - Bin 3 phase	03 / 04	0.001°	0B2E	2	BB2E	2
Interharmonic Group 54 - Bin 4 magnitude	03 / 04	0.001% / mV / mA	0B30	2	BB30	2
Interharmonic Group 54 - Bin 4 phase	03 / 04	0.001°	0B32	2	BB32	2
Interharmonic Group 54 - Bin 5 magnitude	03 / 04	0.001% / mV / mA	0B34	2	BB34	2
Interharmonic Group 54 - Bin 5 phase	03 / 04	0.001°	0B36	2	BB36	2
Interharmonic Group 54 - Bin 6 magnitude	03 / 04	0.001% / mV / mA	0B38	2	BB38	2
Interharmonic Group 54 - Bin 6 phase	03 / 04	0.001°	0B3A	2	BB3A	2
Interharmonic Group 54 - Bin 7 magnitude	03 / 04	0.001% / mV / mA	0B3C	2	BB3C	2
Interharmonic Group 54 - Bin 7 phase	03 / 04	0.001°	0B3E	2	BB3E	2

Parameter	F. code (Hex)	M.U.	INTEGER		IEEE	
			Register (Hex)	Words	Register (Hex)	Words
VOLTAGE & CURRENT HARMONICS & INTERHARMONICS MAGNITUDE&PHASE - fnom=60 Hz						
Interharmonic Group 54 - Bin 8 magnitude	03 / 04	0.001% / mV / mA	0B40	2	BB40	2
Interharmonic Group 54 - Bin 8 phase	03 / 04	0.001°	0B42	2	BB42	2
Interharmonic Group 54 - Bin 9 magnitude	03 / 04	0.001% / mV / mA	0B44	2	BB44	2
Interharmonic Group 54 - Bin 9 phase	03 / 04	0.001°	0B46	2	BB46	2
Interharmonic Group 54 - Bin 10 magnitude	03 / 04	0.001% / mV / mA	0B48	2	BB48	2
Interharmonic Group 54 - Bin 10 phase	03 / 04	0.001°	0B4A	2	BB4A	2
Interharmonic Group 54 - Bin 11 magnitude	03 / 04	0.001% / mV / mA	0B4C	2	BB4C	2
Interharmonic Group 54 - Bin 11 phase	03 / 04	0.001°	0B4E	2	BB4E	2
55th Harmonic Component - Magnitude	03 / 04	0.001% / mV / mA	0B50	2	BB50	2
55th Harmonic Component - Phase	03 / 04	0.001°	0B52	2	BB52	2
Interharmonic Group 55 - Bin 1 magnitude	03 / 04	0.001% / mV / mA	0B54	2	BB54	2
Interharmonic Group 55 - Bin 1 phase	03 / 04	0.001°	0B56	2	BB56	2
Interharmonic Group 55 - Bin 2 magnitude	03 / 04	0.001% / mV / mA	0B58	2	BB58	2
Interharmonic Group 55 - Bin 2 phase	03 / 04	0.001°	0B5A	2	BB5A	2
Interharmonic Group 55 - Bin 3 magnitude	03 / 04	0.001% / mV / mA	0B5C	2	BB5C	2
Interharmonic Group 55 - Bin 3 phase	03 / 04	0.001°	0B5E	2	BB5E	2
Interharmonic Group 55 - Bin 4 magnitude	03 / 04	0.001% / mV / mA	0B60	2	BB60	2
Interharmonic Group 55 - Bin 4 phase	03 / 04	0.001°	0B62	2	BB62	2
Interharmonic Group 55 - Bin 5 magnitude	03 / 04	0.001% / mV / mA	0B64	2	BB64	2
Interharmonic Group 55 - Bin 5 phase	03 / 04	0.001°	0B66	2	BB66	2
Interharmonic Group 55 - Bin 6 magnitude	03 / 04	0.001% / mV / mA	0B68	2	BB68	2
Interharmonic Group 55 - Bin 6 phase	03 / 04	0.001°	0B6A	2	BB6A	2
Interharmonic Group 55 - Bin 7 magnitude	03 / 04	0.001% / mV / mA	0B6C	2	BB6C	2
Interharmonic Group 55 - Bin 7 phase	03 / 04	0.001°	0B6E	2	BB6E	2
Interharmonic Group 55 - Bin 8 magnitude	03 / 04	0.001% / mV / mA	0B70	2	BB70	2
Interharmonic Group 55 - Bin 8 phase	03 / 04	0.001°	0B72	2	BB72	2
Interharmonic Group 55 - Bin 9 magnitude	03 / 04	0.001% / mV / mA	0B74	2	BB74	2
Interharmonic Group 55 - Bin 9 phase	03 / 04	0.001°	0B76	2	BB76	2
Interharmonic Group 55 - Bin 10 magnitude	03 / 04	0.001% / mV / mA	0B78	2	BB78	2
Interharmonic Group 55 - Bin 10 phase	03 / 04	0.001°	0B7A	2	BB7A	2
Interharmonic Group 55 - Bin 11 magnitude	03 / 04	0.001% / mV / mA	0B7C	2	BB7C	2
Interharmonic Group 55 - Bin 11 phase	03 / 04	0.001°	0B7E	2	BB7E	2
56th Harmonic Component - Magnitude	03 / 04	0.001% / mV / mA	0B80	2	BB80	2
56th Harmonic Component - Phase	03 / 04	0.001°	0B82	2	BB82	2
Interharmonic Group 56 - Bin 1 magnitude	03 / 04	0.001% / mV / mA	0B84	2	BB84	2
Interharmonic Group 56 - Bin 1 phase	03 / 04	0.001°	0B86	2	BB86	2
Interharmonic Group 56 - Bin 2 magnitude	03 / 04	0.001% / mV / mA	0B88	2	BB88	2
Interharmonic Group 56 - Bin 2 phase	03 / 04	0.001°	0B8A	2	BB8A	2
Interharmonic Group 56 - Bin 3 magnitude	03 / 04	0.001% / mV / mA	0B8C	2	BB8C	2
Interharmonic Group 56 - Bin 3 phase	03 / 04	0.001°	0B8E	2	BB8E	2
Interharmonic Group 56 - Bin 4 magnitude	03 / 04	0.001% / mV / mA	0B90	2	BB90	2
Interharmonic Group 56 - Bin 4 phase	03 / 04	0.001°	0B92	2	BB92	2
Interharmonic Group 56 - Bin 5 magnitude	03 / 04	0.001% / mV / mA	0B94	2	BB94	2
Interharmonic Group 56 - Bin 5 phase	03 / 04	0.001°	0B96	2	BB96	2
Interharmonic Group 56 - Bin 6 magnitude	03 / 04	0.001% / mV / mA	0B98	2	BB98	2
Interharmonic Group 56 - Bin 6 phase	03 / 04	0.001°	0B9A	2	BB9A	2
Interharmonic Group 56 - Bin 7 magnitude	03 / 04	0.001% / mV / mA	0B9C	2	BB9C	2
Interharmonic Group 56 - Bin 7 phase	03 / 04	0.001°	0B9E	2	BB9E	2
Interharmonic Group 56 - Bin 8 magnitude	03 / 04	0.001% / mV / mA	0BA0	2	BBA0	2
Interharmonic Group 56 - Bin 8 phase	03 / 04	0.001°	0BA2	2	BBA2	2

Parameter	F. code (Hex)	M.U.	INTEGER		IEEE	
			Register (Hex)	Words	Register (Hex)	Words
VOLTAGE & CURRENT HARMONICS & INTERHARMONICS MAGNITUDE&PHASE - fnom=60 Hz						
Interharmonic Group 56 - Bin 9 magnitude	03 / 04	0.001% / mV / mA	0BA4	2	BBA4	2
Interharmonic Group 56 - Bin 9 phase	03 / 04	0.001°	0BA6	2	BBA6	2
Interharmonic Group 56 - Bin 10 magnitude	03 / 04	0.001% / mV / mA	0BA8	2	BBA8	2
Interharmonic Group 56 - Bin 10 phase	03 / 04	0.001°	0BAA	2	BBAA	2
Interharmonic Group 56 - Bin 11 magnitude	03 / 04	0.001% / mV / mA	0BAC	2	BBAC	2
Interharmonic Group 56 - Bin 11 phase	03 / 04	0.001°	0BAE	2	BBAE	2
57th Harmonic Component - Magnitude	03 / 04	0.001% / mV / mA	0BB0	2	BBB0	2
57th Harmonic Component - Phase	03 / 04	0.001°	0BB2	2	BBB2	2
Interharmonic Group 57 - Bin 1 magnitude	03 / 04	0.001% / mV / mA	0BB4	2	BBB4	2
Interharmonic Group 57 - Bin 1 phase	03 / 04	0.001°	0BB6	2	BBB6	2
Interharmonic Group 57 - Bin 2 magnitude	03 / 04	0.001% / mV / mA	0BB8	2	BBB8	2
Interharmonic Group 57 - Bin 2 phase	03 / 04	0.001°	0BBA	2	BBBA	2
Interharmonic Group 57 - Bin 3 magnitude	03 / 04	0.001% / mV / mA	0BBC	2	BBBC	2
Interharmonic Group 57 - Bin 3 phase	03 / 04	0.001°	0BBE	2	BBBE	2
Interharmonic Group 57 - Bin 4 magnitude	03 / 04	0.001% / mV / mA	0BC0	2	BBC0	2
Interharmonic Group 57 - Bin 4 phase	03 / 04	0.001°	0BC2	2	BBC2	2
Interharmonic Group 57 - Bin 5 magnitude	03 / 04	0.001% / mV / mA	0BC4	2	BBC4	2
Interharmonic Group 57 - Bin 5 phase	03 / 04	0.001°	0BC6	2	BBC6	2
Interharmonic Group 57 - Bin 6 magnitude	03 / 04	0.001% / mV / mA	0BC8	2	BBC8	2
Interharmonic Group 57 - Bin 6 phase	03 / 04	0.001°	0BCA	2	BBCA	2
Interharmonic Group 57 - Bin 7 magnitude	03 / 04	0.001% / mV / mA	0BCC	2	BBCC	2
Interharmonic Group 57 - Bin 7 phase	03 / 04	0.001°	0BCE	2	BBCE	2
Interharmonic Group 57 - Bin 8 magnitude	03 / 04	0.001% / mV / mA	0BD0	2	BBD0	2
Interharmonic Group 57 - Bin 8 phase	03 / 04	0.001°	0BD2	2	BBD2	2
Interharmonic Group 57 - Bin 9 magnitude	03 / 04	0.001% / mV / mA	0BD4	2	BBD4	2
Interharmonic Group 57 - Bin 9 phase	03 / 04	0.001°	0BD6	2	BBD6	2
Interharmonic Group 57 - Bin 10 magnitude	03 / 04	0.001% / mV / mA	0BD8	2	BBD8	2
Interharmonic Group 57 - Bin 10 phase	03 / 04	0.001°	0BDA	2	BBDA	2
Interharmonic Group 57 - Bin 11 magnitude	03 / 04	0.001% / mV / mA	0BDC	2	BBDC	2
Interharmonic Group 57 - Bin 11 phase	03 / 04	0.001°	0BDE	2	BBDE	2
58th Harmonic Component - Magnitude	03 / 04	0.001% / mV / mA	0BE0	2	BBE0	2
58th Harmonic Component - Phase	03 / 04	0.001°	0BE2	2	BBE2	2
Interharmonic Group 58 - Bin 1 magnitude	03 / 04	0.001% / mV / mA	0BE4	2	BBE4	2
Interharmonic Group 58 - Bin 1 phase	03 / 04	0.001°	0BE6	2	BBE6	2
Interharmonic Group 58 - Bin 2 magnitude	03 / 04	0.001% / mV / mA	0BE8	2	BBE8	2
Interharmonic Group 58 - Bin 2 phase	03 / 04	0.001°	0BEA	2	BBEA	2
Interharmonic Group 58 - Bin 3 magnitude	03 / 04	0.001% / mV / mA	0BEC	2	BBEC	2
Interharmonic Group 58 - Bin 3 phase	03 / 04	0.001°	0BEE	2	BBEE	2
Interharmonic Group 58 - Bin 4 magnitude	03 / 04	0.001% / mV / mA	0BF0	2	BBF0	2
Interharmonic Group 58 - Bin 4 phase	03 / 04	0.001°	0BF2	2	BBF2	2
Interharmonic Group 58 - Bin 5 magnitude	03 / 04	0.001% / mV / mA	0BF4	2	BBF4	2
Interharmonic Group 58 - Bin 5 phase	03 / 04	0.001°	0BF6	2	BBF6	2
Interharmonic Group 58 - Bin 6 magnitude	03 / 04	0.001% / mV / mA	0BF8	2	BBF8	2
Interharmonic Group 58 - Bin 6 phase	03 / 04	0.001°	0BFA	2	BBFA	2
Interharmonic Group 58 - Bin 7 magnitude	03 / 04	0.001% / mV / mA	0BFC	2	BBFC	2
Interharmonic Group 58 - Bin 7 phase	03 / 04	0.001°	0BFE	2	BBFE	2
Interharmonic Group 58 - Bin 8 magnitude	03 / 04	0.001% / mV / mA	0C00	2	BC00	2
Interharmonic Group 58 - Bin 8 phase	03 / 04	0.001°	0C02	2	BC02	2
Interharmonic Group 58 - Bin 9 magnitude	03 / 04	0.001% / mV / mA	0C04	2	BC04	2
Interharmonic Group 58 - Bin 9 phase	03 / 04	0.001°	0C06	2	BC06	2

Parameter	F. code (Hex)	M.U.	INTEGER		IEEE	
			Register (Hex)	Words	Register (Hex)	Words
VOLTAGE & CURRENT HARMONICS & INTERHARMONICS MAGNITUDE&PHASE - fnom=60 Hz						
Interharmonic Group 58 - Bin 10 magnitude	03 / 04	0.001% / mV / mA	0C08	2	BC08	2
Interharmonic Group 58 - Bin 10 phase	03 / 04	0.001°	0C0A	2	BC0A	2
Interharmonic Group 58 - Bin 11 magnitude	03 / 04	0.001% / mV / mA	0C0C	2	BC0C	2
Interharmonic Group 58 - Bin 11 phase	03 / 04	0.001°	0C0E	2	BC0E	2
59th Harmonic Component - Magnitude	03 / 04	0.001% / mV / mA	0C10	2	BC10	2
59th Harmonic Component - Phase	03 / 04	0.001°	0C12	2	BC12	2
Interharmonic Group 59 - Bin 1 magnitude	03 / 04	0.001% / mV / mA	0C14	2	BC14	2
Interharmonic Group 59 - Bin 1 phase	03 / 04	0.001°	0C16	2	BC16	2
Interharmonic Group 59 - Bin 2 magnitude	03 / 04	0.001% / mV / mA	0C18	2	BC18	2
Interharmonic Group 59 - Bin 2 phase	03 / 04	0.001°	0C1A	2	BC1A	2
Interharmonic Group 59 - Bin 3 magnitude	03 / 04	0.001% / mV / mA	0C1C	2	BC1C	2
Interharmonic Group 59 - Bin 3 phase	03 / 04	0.001°	0C1E	2	BC1E	2
Interharmonic Group 59 - Bin 4 magnitude	03 / 04	0.001% / mV / mA	0C20	2	BC20	2
Interharmonic Group 59 - Bin 4 phase	03 / 04	0.001°	0C22	2	BC22	2
Interharmonic Group 59 - Bin 5 magnitude	03 / 04	0.001% / mV / mA	0C24	2	BC24	2
Interharmonic Group 59 - Bin 5 phase	03 / 04	0.001°	0C26	2	BC26	2
Interharmonic Group 59 - Bin 6 magnitude	03 / 04	0.001% / mV / mA	0C28	2	BC28	2
Interharmonic Group 59 - Bin 6 phase	03 / 04	0.001°	0C2A	2	BC2A	2
Interharmonic Group 59 - Bin 7 magnitude	03 / 04	0.001% / mV / mA	0C2C	2	BC2C	2
Interharmonic Group 59 - Bin 7 phase	03 / 04	0.001°	0C2E	2	BC2E	2
Interharmonic Group 59 - Bin 8 magnitude	03 / 04	0.001% / mV / mA	0C30	2	BC30	2
Interharmonic Group 59 - Bin 8 phase	03 / 04	0.001°	0C32	2	BC32	2
Interharmonic Group 59 - Bin 9 magnitude	03 / 04	0.001% / mV / mA	0C34	2	BC34	2
Interharmonic Group 59 - Bin 9 phase	03 / 04	0.001°	0C36	2	BC36	2
Interharmonic Group 59 - Bin 10 magnitude	03 / 04	0.001% / mV / mA	0C38	2	BC38	2
Interharmonic Group 59 - Bin 10 phase	03 / 04	0.001°	0C3A	2	BC3A	2
Interharmonic Group 59 - Bin 11 magnitude	03 / 04	0.001% / mV / mA	0C3C	2	BC3C	2
Interharmonic Group 59 - Bin 11 phase	03 / 04	0.001°	0C3E	2	BC3E	2
60th Harmonic Component - Magnitude	03 / 04	0.001% / mV / mA	0C40	2	BC40	2
60th Harmonic Component - Phase	03 / 04	0.001°	0C42	2	BC42	2
Interharmonic Group 60 - Bin 1 magnitude	03 / 04	0.001% / mV / mA	0C44	2	BC44	2
Interharmonic Group 60 - Bin 1 phase	03 / 04	0.001°	0C46	2	BC46	2
Interharmonic Group 60 - Bin 2 magnitude	03 / 04	0.001% / mV / mA	0C48	2	BC48	2
Interharmonic Group 60 - Bin 2 phase	03 / 04	0.001°	0C4A	2	BC4A	2
Interharmonic Group 60 - Bin 3 magnitude	03 / 04	0.001% / mV / mA	0C4C	2	BC4C	2
Interharmonic Group 60 - Bin 3 phase	03 / 04	0.001°	0C4E	2	BC4E	2
Interharmonic Group 60 - Bin 4 magnitude	03 / 04	0.001% / mV / mA	0C50	2	BC50	2
Interharmonic Group 60 - Bin 4 phase	03 / 04	0.001°	0C52	2	BC52	2
Interharmonic Group 60 - Bin 5 magnitude	03 / 04	0.001% / mV / mA	0C54	2	BC54	2
Interharmonic Group 60 - Bin 5 phase	03 / 04	0.001°	0C56	2	BC56	2
Interharmonic Group 60 - Bin 6 magnitude	03 / 04	0.001% / mV / mA	0C58	2	BC58	2
Interharmonic Group 60 - Bin 6 phase	03 / 04	0.001°	0C5A	2	BC5A	2
Interharmonic Group 60 - Bin 7 magnitude	03 / 04	0.001% / mV / mA	0C5C	2	BC5C	2
Interharmonic Group 60 - Bin 7 phase	03 / 04	0.001°	0C5E	2	BC5E	2
Interharmonic Group 60 - Bin 8 magnitude	03 / 04	0.001% / mV / mA	0C60	2	BC60	2
Interharmonic Group 60 - Bin 8 phase	03 / 04	0.001°	0C62	2	BC62	2
Interharmonic Group 60 - Bin 9 magnitude	03 / 04	0.001% / mV / mA	0C64	2	BC64	2
Interharmonic Group 60 - Bin 9 phase	03 / 04	0.001°	0C66	2	BC66	2
Interharmonic Group 60 - Bin 10 magnitude	03 / 04	0.001% / mV / mA	0C68	2	BC68	2
Interharmonic Group 60 - Bin 10 phase	03 / 04	0.001°	0C6A	2	BC6A	2

Parameter	F. code (Hex)	M.U.	INTEGER		IEEE	
			Register (Hex)	Words	Register (Hex)	Words
VOLTAGE & CURRENT HARMONICS & INTERHARMONICS MAGNITUDE&PHASE - fnom=60 Hz						
Interharmonic Group 60 - Bin 11 magnitude	03 / 04	0.001% / mV / mA	0C6C	2	BC6C	2
Interharmonic Group 60 - Bin 11 phase	03 / 04	0.001°	0C6E	2	BC6E	2
61st Harmonic Component - Magnitude	03 / 04	0.001% / mV / mA	0C70	2	BC70	2
61st Harmonic Component - Phase	03 / 04	0.001°	0C72	2	BC72	2
Interharmonic Group 61 - Bin 1 magnitude	03 / 04	0.001% / mV / mA	0C74	2	BC74	2
Interharmonic Group 61 - Bin 1 phase	03 / 04	0.001°	0C76	2	BC76	2
Interharmonic Group 61 - Bin 2 magnitude	03 / 04	0.001% / mV / mA	0C78	2	BC78	2
Interharmonic Group 61 - Bin 2 phase	03 / 04	0.001°	0C7A	2	BC7A	2
Interharmonic Group 61 - Bin 3 magnitude	03 / 04	0.001% / mV / mA	0C7C	2	BC7C	2
Interharmonic Group 61 - Bin 3 phase	03 / 04	0.001°	0C7E	2	BC7E	2
Interharmonic Group 61 - Bin 4 magnitude	03 / 04	0.001% / mV / mA	0C80	2	BC80	2
Interharmonic Group 61 - Bin 4 phase	03 / 04	0.001°	0C82	2	BC82	2
Interharmonic Group 61 - Bin 5 magnitude	03 / 04	0.001% / mV / mA	0C84	2	BC84	2
Interharmonic Group 61 - Bin 5 phase	03 / 04	0.001°	0C86	2	BC86	2
Interharmonic Group 61 - Bin 6 magnitude	03 / 04	0.001% / mV / mA	0C88	2	BC88	2
Interharmonic Group 61 - Bin 6 phase	03 / 04	0.001°	0C8A	2	BC8A	2
Interharmonic Group 61 - Bin 7 magnitude	03 / 04	0.001% / mV / mA	0C8C	2	BC8C	2
Interharmonic Group 61 - Bin 7 phase	03 / 04	0.001°	0C8E	2	BC8E	2
Interharmonic Group 61 - Bin 8 magnitude	03 / 04	0.001% / mV / mA	0C90	2	BC90	2
Interharmonic Group 61 - Bin 8 phase	03 / 04	0.001°	0C92	2	BC92	2
Interharmonic Group 61 - Bin 9 magnitude	03 / 04	0.001% / mV / mA	0C94	2	BC94	2
Interharmonic Group 61 - Bin 9 phase	03 / 04	0.001°	0C96	2	BC96	2
Interharmonic Group 61 - Bin 10 magnitude	03 / 04	0.001% / mV / mA	0C98	2	BC98	2
Interharmonic Group 61 - Bin 10 phase	03 / 04	0.001°	0C9A	2	BC9A	2
Interharmonic Group 61 - Bin 11 magnitude	03 / 04	0.001% / mV / mA	0C9C	2	BC9C	2
Interharmonic Group 61 - Bin 11 phase	03 / 04	0.001°	0C9E	2	BC9E	2
62nd Harmonic Component - Magnitude	03 / 04	0.001% / mV / mA	0CA0	2	BCA0	2
62nd Harmonic Component - Phase	03 / 04	0.001°	0CA2	2	BCA2	2
Interharmonic Group 62 - Bin 1 magnitude	03 / 04	0.001% / mV / mA	0CA4	2	BCA4	2
Interharmonic Group 62 - Bin 1 phase	03 / 04	0.001°	0CA6	2	BCA6	2
Interharmonic Group 62 - Bin 2 magnitude	03 / 04	0.001% / mV / mA	0CA8	2	BCA8	2
Interharmonic Group 62 - Bin 2 phase	03 / 04	0.001°	0CAA	2	BCAA	2
Interharmonic Group 62 - Bin 3 magnitude	03 / 04	0.001% / mV / mA	0CAC	2	BCAC	2
Interharmonic Group 62 - Bin 3 phase	03 / 04	0.001°	0CAE	2	BCAE	2
Interharmonic Group 62 - Bin 4 magnitude	03 / 04	0.001% / mV / mA	0CB0	2	BCB0	2
Interharmonic Group 62 - Bin 4 phase	03 / 04	0.001°	0CB2	2	BCB2	2
Interharmonic Group 62 - Bin 5 magnitude	03 / 04	0.001% / mV / mA	0CB4	2	BCB4	2
Interharmonic Group 62 - Bin 5 phase	03 / 04	0.001°	0CB6	2	BCB6	2
Interharmonic Group 62 - Bin 6 magnitude	03 / 04	0.001% / mV / mA	0CB8	2	BCB8	2
Interharmonic Group 62 - Bin 6 phase	03 / 04	0.001°	0CBA	2	BCBA	2
Interharmonic Group 62 - Bin 7 magnitude	03 / 04	0.001% / mV / mA	0CBC	2	BCBC	2
Interharmonic Group 62 - Bin 7 phase	03 / 04	0.001°	0CBE	2	BCBE	2
Interharmonic Group 62 - Bin 8 magnitude	03 / 04	0.001% / mV / mA	0CC0	2	BCC0	2
Interharmonic Group 62 - Bin 8 phase	03 / 04	0.001°	0CC2	2	BCC2	2
Interharmonic Group 62 - Bin 9 magnitude	03 / 04	0.001% / mV / mA	0CC4	2	BCC4	2
Interharmonic Group 62 - Bin 9 phase	03 / 04	0.001°	0CC6	2	BCC6	2
Interharmonic Group 62 - Bin 10 magnitude	03 / 04	0.001% / mV / mA	0CC8	2	BCC8	2
Interharmonic Group 62 - Bin 10 phase	03 / 04	0.001°	0CCA	2	BCCA	2
Interharmonic Group 62 - Bin 11 magnitude	03 / 04	0.001% / mV / mA	0CCC	2	BCCC	2
Interharmonic Group 62 - Bin 11 phase	03 / 04	0.001°	0CCE	2	BCCE	2

Parameter	F. code (Hex)	M.U.	INTEGER		IEEE	
			Register (Hex)	Words	Register (Hex)	Words
VOLTAGE & CURRENT HARMONICS & INTERHARMONICS MAGNITUDE&PHASE - fnom=60 Hz						
63rd Harmonic Component - Magnitude	03 / 04	0.001% / mV / mA	0CD0	2	BCD0	2
63rd Harmonic Component - Phase	03 / 04	0.001°	0CD2	2	BCD2	2
Interharmonic Group 63 - Bin 1 magnitude	03 / 04	0.001% / mV / mA	0CD4	2	BCD4	2
Interharmonic Group 63 - Bin 1 phase	03 / 04	0.001°	0CD6	2	BCD6	2
Interharmonic Group 63 - Bin 2 magnitude	03 / 04	0.001% / mV / mA	0CD8	2	BCD8	2
Interharmonic Group 63 - Bin 2 phase	03 / 04	0.001°	0CDA	2	BCDA	2
Interharmonic Group 63 - Bin 3 magnitude	03 / 04	0.001% / mV / mA	0CDC	2	BCDC	2
Interharmonic Group 63 - Bin 3 phase	03 / 04	0.001°	0CDE	2	BCDE	2
Interharmonic Group 63 - Bin 4 magnitude	03 / 04	0.001% / mV / mA	0CE0	2	BCE0	2
Interharmonic Group 63 - Bin 4 phase	03 / 04	0.001°	0CE2	2	BCE2	2
Interharmonic Group 63 - Bin 5 magnitude	03 / 04	0.001% / mV / mA	0CE4	2	BCE4	2
Interharmonic Group 63 - Bin 5 phase	03 / 04	0.001°	0CE6	2	BCE6	2
Interharmonic Group 63 - Bin 6 magnitude	03 / 04	0.001% / mV / mA	0CE8	2	BCE8	2
Interharmonic Group 63 - Bin 6 phase	03 / 04	0.001°	0CEA	2	BCEA	2
Interharmonic Group 63 - Bin 7 magnitude	03 / 04	0.001% / mV / mA	0CEC	2	BCEC	2
Interharmonic Group 63 - Bin 7 phase	03 / 04	0.001°	0CEE	2	BCEE	2
Interharmonic Group 63 - Bin 8 magnitude	03 / 04	0.001% / mV / mA	0CF0	2	BCF0	2
Interharmonic Group 63 - Bin 8 phase	03 / 04	0.001°	0CF2	2	BCF2	2
Interharmonic Group 63 - Bin 9 magnitude	03 / 04	0.001% / mV / mA	0CF4	2	BCF4	2
Interharmonic Group 63 - Bin 9 phase	03 / 04	0.001°	0CF6	2	BCF6	2
Interharmonic Group 63 - Bin 10 magnitude	03 / 04	0.001% / mV / mA	0CF8	2	BCF8	2
Interharmonic Group 63 - Bin 10 phase	03 / 04	0.001°	0CFA	2	BCFA	2
Interharmonic Group 63 - Bin 11 magnitude	03 / 04	0.001% / mV / mA	0CFC	2	BCFC	2
Interharmonic Group 63 - Bin 11 phase	03 / 04	0.001°	0CFE	2	BCFE	2

Parameter	F. code (Hex)	M.U.	INTEGER		IEEE	
			Register (Hex)	Words	Register (Hex)	Words
POWER HARMONICS & INTERHARMONICS - fnom=50 Hz						
Set the parameter for the next reading command. Programmable data: \$01=Phase 1 Active Power (P1) \$02=Phase 2 Active Power (P2) \$03=Phase 3 Active Power (P3) \$04=Phase 1 Reactive Power (Q1) \$05=Phase 2 Reactive Power (Q2) \$06=Phase 3 Reactive Power (Q3) Example To read the Phase 1 active power fundamental (1st) integer: 1. First send writing register 0B00 by programming \$01 for parameter selection. 2. Then, send the reading register 0B2A.	10	-	0B00	2	-	-
WARNING! The harmonic measuring unit changes according to the set display mode. If "Percentage" is set as display mode, the read harmonic will be in percentage values referred to the Fundamental. If "Absolute" is set as display mode, the read harmonic will be in absolute values (mW in case of active power harmonics or mvar in case of reactive power harmonics).						
DC Component	03 / 04	0.001%/mW/mvar	0E02	4	BB02	2
Interharmonic Group 0 - Bin 1	03 / 04	0.001%/mW/mvar	0E06	4	BB04	2
Interharmonic Group 0 - Bin 2	03 / 04	0.001%/mW/mvar	0E0A	4	BB06	2
Interharmonic Group 0 - Bin 3	03 / 04	0.001%/mW/mvar	0E0E	4	BB08	2

Parameter	F. code (Hex)	M.U.	INTEGER		IEEE	
			Register (Hex)	Words	Register (Hex)	Words
POWER HARMONICS & INTERHARMONICS - fnom=50 Hz						
Interharmonic Group 0 - Bin 4	03 / 04	0.001%/mW/mvar	0E12	4	BB0A	2
Interharmonic Group 0 - Bin 5	03 / 04	0.001%/mW/mvar	0E16	4	BB0C	2
Interharmonic Group 0 - Bin 6	03 / 04	0.001%/mW/mvar	0E1A	4	BB0E	2
Interharmonic Group 0 - Bin 7	03 / 04	0.001%/mW/mvar	0E1E	4	BB10	2
Interharmonic Group 0 - Bin 8	03 / 04	0.001%/mW/mvar	0E22	4	BB12	2
Interharmonic Group 0 - Bin 9	03 / 04	0.001%/mW/mvar	0E26	4	BB14	2
1st Harmonic Component	03 / 04	0.001%/mW/mvar	0E2A	4	BB16	2
Interharmonic Group 1 - Bin 1	03 / 04	0.001%/mW/mvar	0E2E	4	BB18	2
Interharmonic Group 1 - Bin 2	03 / 04	0.001%/mW/mvar	0E32	4	BB1A	2
Interharmonic Group 1 - Bin 3	03 / 04	0.001%/mW/mvar	0E36	4	BB1C	2
Interharmonic Group 1 - Bin 4	03 / 04	0.001%/mW/mvar	0E3A	4	BB1E	2
Interharmonic Group 1 - Bin 5	03 / 04	0.001%/mW/mvar	0E3E	4	BB20	2
Interharmonic Group 1 - Bin 6	03 / 04	0.001%/mW/mvar	0E42	4	BB22	2
Interharmonic Group 1 - Bin 7	03 / 04	0.001%/mW/mvar	0E46	4	BB24	2
Interharmonic Group 1 - Bin 8	03 / 04	0.001%/mW/mvar	0E4A	4	BB26	2
Interharmonic Group 1 - Bin 9	03 / 04	0.001%/mW/mvar	0E4E	4	BB28	2
2nd Harmonic Component	03 / 04	0.001%/mW/mvar	0E52	4	BB2A	2
Interharmonic Group 2 - Bin 1	03 / 04	0.001%/mW/mvar	0E56	4	BB2C	2
Interharmonic Group 2 - Bin 2	03 / 04	0.001%/mW/mvar	0E5A	4	BB2E	2
Interharmonic Group 2 - Bin 3	03 / 04	0.001%/mW/mvar	0E5E	4	BB30	2
Interharmonic Group 2 - Bin 4	03 / 04	0.001%/mW/mvar	0E62	4	BB32	2
Interharmonic Group 2 - Bin 5	03 / 04	0.001%/mW/mvar	0E66	4	BB34	2
Interharmonic Group 2 - Bin 6	03 / 04	0.001%/mW/mvar	0E6A	4	BB36	2
Interharmonic Group 2 - Bin 7	03 / 04	0.001%/mW/mvar	0E6E	4	BB38	2
Interharmonic Group 2 - Bin 8	03 / 04	0.001%/mW/mvar	0E72	4	BB3A	2
Interharmonic Group 2 - Bin 9	03 / 04	0.001%/mW/mvar	0E76	4	BB3C	2
3rd Harmonic Component	03 / 04	0.001%/mW/mvar	0E7A	4	BB3E	2
Interharmonic Group 3 - Bin 1	03 / 04	0.001%/mW/mvar	0E7E	4	BB40	2
Interharmonic Group 3 - Bin 2	03 / 04	0.001%/mW/mvar	0E82	4	BB42	2
Interharmonic Group 3 - Bin 3	03 / 04	0.001%/mW/mvar	0E86	4	BB44	2
Interharmonic Group 3 - Bin 4	03 / 04	0.001%/mW/mvar	0E8A	4	BB46	2
Interharmonic Group 3 - Bin 5	03 / 04	0.001%/mW/mvar	0E8E	4	BB48	2
Interharmonic Group 3 - Bin 6	03 / 04	0.001%/mW/mvar	0E92	4	BB4A	2
Interharmonic Group 3 - Bin 7	03 / 04	0.001%/mW/mvar	0E96	4	BB4C	2
Interharmonic Group 3 - Bin 8	03 / 04	0.001%/mW/mvar	0E9A	4	BB4E	2
Interharmonic Group 3 - Bin 9	03 / 04	0.001%/mW/mvar	0E9E	4	BB50	2
4th Harmonic Component	03 / 04	0.001%/mW/mvar	0EA2	4	BB52	2
Interharmonic Group 4 - Bin 1	03 / 04	0.001%/mW/mvar	0EA6	4	BB54	2
Interharmonic Group 4 - Bin 2	03 / 04	0.001%/mW/mvar	0EAA	4	BB56	2
Interharmonic Group 4 - Bin 3	03 / 04	0.001%/mW/mvar	0EAE	4	BB58	2
Interharmonic Group 4 - Bin 4	03 / 04	0.001%/mW/mvar	0EB2	4	BB5A	2
Interharmonic Group 4 - Bin 5	03 / 04	0.001%/mW/mvar	0EB6	4	BB5C	2
Interharmonic Group 4 - Bin 6	03 / 04	0.001%/mW/mvar	0EBA	4	BB5E	2
Interharmonic Group 4 - Bin 7	03 / 04	0.001%/mW/mvar	0EBE	4	BB60	2
Interharmonic Group 4 - Bin 8	03 / 04	0.001%/mW/mvar	0EC2	4	BB62	2
Interharmonic Group 4 - Bin 9	03 / 04	0.001%/mW/mvar	0EC6	4	BB64	2
5th Harmonic Component	03 / 04	0.001%/mW/mvar	0ECA	4	BB66	2
Interharmonic Group 5 - Bin 1	03 / 04	0.001%/mW/mvar	0ECE	4	BB68	2
Interharmonic Group 5 - Bin 2	03 / 04	0.001%/mW/mvar	0ED2	4	BB6A	2
Interharmonic Group 5 - Bin 3	03 / 04	0.001%/mW/mvar	0ED6	4	BB6C	2

Parameter	F. code (Hex)	M.U.	INTEGER		IEEE	
			Register (Hex)	Words	Register (Hex)	Words
POWER HARMONICS & INTERHARMONICS - fnom=50 Hz						
Interharmonic Group 5 - Bin 4	03 / 04	0.001%/mW/mvar	0EDA	4	BB6E	2
Interharmonic Group 5 - Bin 5	03 / 04	0.001%/mW/mvar	0EDE	4	BB70	2
Interharmonic Group 5 - Bin 6	03 / 04	0.001%/mW/mvar	0EE2	4	BB72	2
Interharmonic Group 5 - Bin 7	03 / 04	0.001%/mW/mvar	0EE6	4	BB74	2
Interharmonic Group 5 - Bin 8	03 / 04	0.001%/mW/mvar	0EEA	4	BB76	2
Interharmonic Group 5 - Bin 9	03 / 04	0.001%/mW/mvar	0EEE	4	BB78	2
6th Harmonic Component	03 / 04	0.001%/mW/mvar	0EF2	4	BB7A	2
Interharmonic Group 6 - Bin 1	03 / 04	0.001%/mW/mvar	0EF6	4	BB7C	2
Interharmonic Group 6 - Bin 2	03 / 04	0.001%/mW/mvar	0EFA	4	BB7E	2
Interharmonic Group 6 - Bin 3	03 / 04	0.001%/mW/mvar	0EFE	4	BB80	2
Interharmonic Group 6 - Bin 4	03 / 04	0.001%/mW/mvar	0F02	4	BB82	2
Interharmonic Group 6 - Bin 5	03 / 04	0.001%/mW/mvar	0F06	4	BB84	2
Interharmonic Group 6 - Bin 6	03 / 04	0.001%/mW/mvar	0F0A	4	BB86	2
Interharmonic Group 6 - Bin 7	03 / 04	0.001%/mW/mvar	0F0E	4	BB88	2
Interharmonic Group 6 - Bin 8	03 / 04	0.001%/mW/mvar	0F12	4	BB8A	2
Interharmonic Group 6 - Bin 9	03 / 04	0.001%/mW/mvar	0F16	4	BB8C	2
7th Harmonic Component	03 / 04	0.001%/mW/mvar	0F1A	4	BB8E	2
Interharmonic Group 7 - Bin 1	03 / 04	0.001%/mW/mvar	0F1E	4	BB90	2
Interharmonic Group 7 - Bin 2	03 / 04	0.001%/mW/mvar	0F22	4	BB92	2
Interharmonic Group 7 - Bin 3	03 / 04	0.001%/mW/mvar	0F26	4	BB94	2
Interharmonic Group 7 - Bin 4	03 / 04	0.001%/mW/mvar	0F2A	4	BB96	2
Interharmonic Group 7 - Bin 5	03 / 04	0.001%/mW/mvar	0F2E	4	BB98	2
Interharmonic Group 7 - Bin 6	03 / 04	0.001%/mW/mvar	0F32	4	BB9A	2
Interharmonic Group 7 - Bin 7	03 / 04	0.001%/mW/mvar	0F36	4	BB9C	2
Interharmonic Group 7 - Bin 8	03 / 04	0.001%/mW/mvar	0F3A	4	BB9E	2
Interharmonic Group 7 - Bin 9	03 / 04	0.001%/mW/mvar	0F3E	4	BBA0	2
8th Harmonic Component	03 / 04	0.001%/mW/mvar	0F42	4	BBA2	2
Interharmonic Group 8 - Bin 1	03 / 04	0.001%/mW/mvar	0F46	4	BBA4	2
Interharmonic Group 8 - Bin 2	03 / 04	0.001%/mW/mvar	0F4A	4	BBA6	2
Interharmonic Group 8 - Bin 3	03 / 04	0.001%/mW/mvar	0F4E	4	BBA8	2
Interharmonic Group 8 - Bin 4	03 / 04	0.001%/mW/mvar	0F52	4	BBAA	2
Interharmonic Group 8 - Bin 5	03 / 04	0.001%/mW/mvar	0F56	4	BBAC	2
Interharmonic Group 8 - Bin 6	03 / 04	0.001%/mW/mvar	0F5A	4	BBAE	2
Interharmonic Group 8 - Bin 7	03 / 04	0.001%/mW/mvar	0F5E	4	BBB0	2
Interharmonic Group 8 - Bin 8	03 / 04	0.001%/mW/mvar	0F62	4	BBB2	2
Interharmonic Group 8 - Bin 9	03 / 04	0.001%/mW/mvar	0F66	4	BBB4	2
9th Harmonic Component	03 / 04	0.001%/mW/mvar	0F6A	4	BBB6	2
Interharmonic Group 9 - Bin 1	03 / 04	0.001%/mW/mvar	0F6E	4	BBB8	2
Interharmonic Group 9 - Bin 2	03 / 04	0.001%/mW/mvar	0F72	4	BBBA	2
Interharmonic Group 9 - Bin 3	03 / 04	0.001%/mW/mvar	0F76	4	BBBC	2
Interharmonic Group 9 - Bin 4	03 / 04	0.001%/mW/mvar	0F7A	4	BBBE	2
Interharmonic Group 9 - Bin 5	03 / 04	0.001%/mW/mvar	0F7E	4	BBC0	2
Interharmonic Group 9 - Bin 6	03 / 04	0.001%/mW/mvar	0F82	4	BBC2	2
Interharmonic Group 9 - Bin 7	03 / 04	0.001%/mW/mvar	0F86	4	BBC4	2
Interharmonic Group 9 - Bin 8	03 / 04	0.001%/mW/mvar	0F8A	4	BBC6	2
Interharmonic Group 9 - Bin 9	03 / 04	0.001%/mW/mvar	0F8E	4	BBC8	2
10th Harmonic Component	03 / 04	0.001%/mW/mvar	0F92	4	BBCA	2
Interharmonic Group 10 - Bin 1	03 / 04	0.001%/mW/mvar	0F96	4	BBCC	2
Interharmonic Group 10 - Bin 2	03 / 04	0.001%/mW/mvar	0F9A	4	BBCE	2
Interharmonic Group 10 - Bin 3	03 / 04	0.001%/mW/mvar	0F9E	4	BBD0	2

Parameter	F. code (Hex)	M.U.	INTEGER		IEEE	
			Register (Hex)	Words	Register (Hex)	Words
POWER HARMONICS & INTERHARMONICS - fnom=50 Hz						
Interharmonic Group 10 - Bin 4	03 / 04	0.001%/mW/mvar	0FA2	4	BBD2	2
Interharmonic Group 10 - Bin 5	03 / 04	0.001%/mW/mvar	0FA6	4	BBD4	2
Interharmonic Group 10 - Bin 6	03 / 04	0.001%/mW/mvar	0FAA	4	BBD6	2
Interharmonic Group 10 - Bin 7	03 / 04	0.001%/mW/mvar	0FAE	4	BBD8	2
Interharmonic Group 10 - Bin 8	03 / 04	0.001%/mW/mvar	0FB2	4	BBDA	2
Interharmonic Group 10 - Bin 9	03 / 04	0.001%/mW/mvar	0FB6	4	BBDC	2
11th Harmonic Component	03 / 04	0.001%/mW/mvar	0FBA	4	BBDE	2
Interharmonic Group 11 - Bin 1	03 / 04	0.001%/mW/mvar	0FBE	4	BBE0	2
Interharmonic Group 11 - Bin 2	03 / 04	0.001%/mW/mvar	0FC2	4	BBE2	2
Interharmonic Group 11 - Bin 3	03 / 04	0.001%/mW/mvar	0FC6	4	BBE4	2
Interharmonic Group 11 - Bin 4	03 / 04	0.001%/mW/mvar	0FCA	4	BBE6	2
Interharmonic Group 11 - Bin 5	03 / 04	0.001%/mW/mvar	0FCE	4	BBE8	2
Interharmonic Group 11 - Bin 6	03 / 04	0.001%/mW/mvar	0FD2	4	BBEA	2
Interharmonic Group 11 - Bin 7	03 / 04	0.001%/mW/mvar	0FD6	4	BBEC	2
Interharmonic Group 11 - Bin 8	03 / 04	0.001%/mW/mvar	0FDA	4	BBEE	2
Interharmonic Group 11 - Bin 9	03 / 04	0.001%/mW/mvar	0FDE	4	BBF0	2
12th Harmonic Component	03 / 04	0.001%/mW/mvar	0FE2	4	BBF2	2
Interharmonic Group 12 - Bin 1	03 / 04	0.001%/mW/mvar	0FE6	4	BBF4	2
Interharmonic Group 12 - Bin 2	03 / 04	0.001%/mW/mvar	0FEA	4	BBF6	2
Interharmonic Group 12 - Bin 3	03 / 04	0.001%/mW/mvar	0FEE	4	BBF8	2
Interharmonic Group 12 - Bin 4	03 / 04	0.001%/mW/mvar	0FF2	4	BBFA	2
Interharmonic Group 12 - Bin 5	03 / 04	0.001%/mW/mvar	0FF6	4	BBFC	2
Interharmonic Group 12 - Bin 6	03 / 04	0.001%/mW/mvar	0FFA	4	BBFE	2
Interharmonic Group 12 - Bin 7	03 / 04	0.001%/mW/mvar	0FFE	4	BC00	2
Interharmonic Group 12 - Bin 8	03 / 04	0.001%/mW/mvar	1002	4	BC02	2
Interharmonic Group 12 - Bin 9	03 / 04	0.001%/mW/mvar	1006	4	BC04	2
13th Harmonic Component	03 / 04	0.001%/mW/mvar	100A	4	BC06	2
Interharmonic Group 13 - Bin 1	03 / 04	0.001%/mW/mvar	100E	4	BC08	2
Interharmonic Group 13 - Bin 2	03 / 04	0.001%/mW/mvar	1012	4	BC0A	2
Interharmonic Group 13 - Bin 3	03 / 04	0.001%/mW/mvar	1016	4	BC0C	2
Interharmonic Group 13 - Bin 4	03 / 04	0.001%/mW/mvar	101A	4	BC0E	2
Interharmonic Group 13 - Bin 5	03 / 04	0.001%/mW/mvar	101E	4	BC10	2
Interharmonic Group 13 - Bin 6	03 / 04	0.001%/mW/mvar	1022	4	BC12	2
Interharmonic Group 13 - Bin 7	03 / 04	0.001%/mW/mvar	1026	4	BC14	2
Interharmonic Group 13 - Bin 8	03 / 04	0.001%/mW/mvar	102A	4	BC16	2
Interharmonic Group 13 - Bin 9	03 / 04	0.001%/mW/mvar	102E	4	BC18	2
14th Harmonic Component	03 / 04	0.001%/mW/mvar	1032	4	BC1A	2
Interharmonic Group 14 - Bin 1	03 / 04	0.001%/mW/mvar	1036	4	BC1C	2
Interharmonic Group 14 - Bin 2	03 / 04	0.001%/mW/mvar	103A	4	BC1E	2
Interharmonic Group 14 - Bin 3	03 / 04	0.001%/mW/mvar	103E	4	BC20	2
Interharmonic Group 14 - Bin 4	03 / 04	0.001%/mW/mvar	1042	4	BC22	2
Interharmonic Group 14 - Bin 5	03 / 04	0.001%/mW/mvar	1046	4	BC24	2
Interharmonic Group 14 - Bin 6	03 / 04	0.001%/mW/mvar	104A	4	BC26	2
Interharmonic Group 14 - Bin 7	03 / 04	0.001%/mW/mvar	104E	4	BC28	2
Interharmonic Group 14 - Bin 8	03 / 04	0.001%/mW/mvar	1052	4	BC2A	2
Interharmonic Group 14 - Bin 9	03 / 04	0.001%/mW/mvar	1056	4	BC2C	2
15th Harmonic Component	03 / 04	0.001%/mW/mvar	105A	4	BC2E	2
Interharmonic Group 15 - Bin 1	03 / 04	0.001%/mW/mvar	105E	4	BC30	2
Interharmonic Group 15 - Bin 2	03 / 04	0.001%/mW/mvar	1062	4	BC32	2
Interharmonic Group 15 - Bin 3	03 / 04	0.001%/mW/mvar	1066	4	BC34	2

Parameter	F. code (Hex)	M.U.	INTEGER		IEEE	
			Register (Hex)	Words	Register (Hex)	Words
POWER HARMONICS & INTERHARMONICS - fnom=50 Hz						
Interharmonic Group 15 - Bin 4	03 / 04	0.001%/mW/mvar	106A	4	BC36	2
Interharmonic Group 15 - Bin 5	03 / 04	0.001%/mW/mvar	106E	4	BC38	2
Interharmonic Group 15 - Bin 6	03 / 04	0.001%/mW/mvar	1072	4	BC3A	2
Interharmonic Group 15 - Bin 7	03 / 04	0.001%/mW/mvar	1076	4	BC3C	2
Interharmonic Group 15 - Bin 8	03 / 04	0.001%/mW/mvar	107A	4	BC3E	2
Interharmonic Group 15 - Bin 9	03 / 04	0.001%/mW/mvar	107E	4	BC40	2
16th Harmonic Component	03 / 04	0.001%/mW/mvar	1082	4	BC42	2
Interharmonic Group 16 - Bin 1	03 / 04	0.001%/mW/mvar	1086	4	BC44	2
Interharmonic Group 16 - Bin 2	03 / 04	0.001%/mW/mvar	108A	4	BC46	2
Interharmonic Group 16 - Bin 3	03 / 04	0.001%/mW/mvar	108E	4	BC48	2
Interharmonic Group 16 - Bin 4	03 / 04	0.001%/mW/mvar	1092	4	BC4A	2
Interharmonic Group 16 - Bin 5	03 / 04	0.001%/mW/mvar	1096	4	BC4C	2
Interharmonic Group 16 - Bin 6	03 / 04	0.001%/mW/mvar	109A	4	BC4E	2
Interharmonic Group 16 - Bin 7	03 / 04	0.001%/mW/mvar	109E	4	BC50	2
Interharmonic Group 16 - Bin 8	03 / 04	0.001%/mW/mvar	10A2	4	BC52	2
Interharmonic Group 16 - Bin 9	03 / 04	0.001%/mW/mvar	10A6	4	BC54	2
17th Harmonic Component	03 / 04	0.001%/mW/mvar	10AA	4	BC56	2
Interharmonic Group 17 - Bin 1	03 / 04	0.001%/mW/mvar	10AE	4	BC58	2
Interharmonic Group 17 - Bin 2	03 / 04	0.001%/mW/mvar	10B2	4	BC5A	2
Interharmonic Group 17 - Bin 3	03 / 04	0.001%/mW/mvar	10B6	4	BC5C	2
Interharmonic Group 17 - Bin 4	03 / 04	0.001%/mW/mvar	10BA	4	BC5E	2
Interharmonic Group 17 - Bin 5	03 / 04	0.001%/mW/mvar	10BE	4	BC60	2
Interharmonic Group 17 - Bin 6	03 / 04	0.001%/mW/mvar	10C2	4	BC62	2
Interharmonic Group 17 - Bin 7	03 / 04	0.001%/mW/mvar	10C6	4	BC64	2
Interharmonic Group 17 - Bin 8	03 / 04	0.001%/mW/mvar	10CA	4	BC66	2
Interharmonic Group 17 - Bin 9	03 / 04	0.001%/mW/mvar	10CE	4	BC68	2
18th Harmonic Component	03 / 04	0.001%/mW/mvar	10D2	4	BC6A	2
Interharmonic Group 18 - Bin 1	03 / 04	0.001%/mW/mvar	10D6	4	BC6C	2
Interharmonic Group 18 - Bin 2	03 / 04	0.001%/mW/mvar	10DA	4	BC6E	2
Interharmonic Group 18 - Bin 3	03 / 04	0.001%/mW/mvar	10DE	4	BC70	2
Interharmonic Group 18 - Bin 4	03 / 04	0.001%/mW/mvar	10E2	4	BC72	2
Interharmonic Group 18 - Bin 5	03 / 04	0.001%/mW/mvar	10E6	4	BC74	2
Interharmonic Group 18 - Bin 6	03 / 04	0.001%/mW/mvar	10EA	4	BC76	2
Interharmonic Group 18 - Bin 7	03 / 04	0.001%/mW/mvar	10EE	4	BC78	2
Interharmonic Group 18 - Bin 8	03 / 04	0.001%/mW/mvar	10F2	4	BC7A	2
Interharmonic Group 18 - Bin 9	03 / 04	0.001%/mW/mvar	10F6	4	BC7C	2
19th Harmonic Component	03 / 04	0.001%/mW/mvar	10FA	4	BC7E	2
Interharmonic Group 19 - Bin 1	03 / 04	0.001%/mW/mvar	10FE	4	BC80	2
Interharmonic Group 19 - Bin 2	03 / 04	0.001%/mW/mvar	1102	4	BC82	2
Interharmonic Group 19 - Bin 3	03 / 04	0.001%/mW/mvar	1106	4	BC84	2
Interharmonic Group 19 - Bin 4	03 / 04	0.001%/mW/mvar	110A	4	BC86	2
Interharmonic Group 19 - Bin 5	03 / 04	0.001%/mW/mvar	110E	4	BC88	2
Interharmonic Group 19 - Bin 6	03 / 04	0.001%/mW/mvar	1112	4	BC8A	2
Interharmonic Group 19 - Bin 7	03 / 04	0.001%/mW/mvar	1116	4	BC8C	2
Interharmonic Group 19 - Bin 8	03 / 04	0.001%/mW/mvar	111A	4	BC8E	2
Interharmonic Group 19 - Bin 9	03 / 04	0.001%/mW/mvar	111E	4	BC90	2
20th Harmonic Component	03 / 04	0.001%/mW/mvar	1122	4	BC92	2
Interharmonic Group 20 - Bin 1	03 / 04	0.001%/mW/mvar	1126	4	BC94	2
Interharmonic Group 20 - Bin 2	03 / 04	0.001%/mW/mvar	112A	4	BC96	2
Interharmonic Group 20 - Bin 3	03 / 04	0.001%/mW/mvar	112E	4	BC98	2

Parameter	F. code (Hex)	M.U.	INTEGER		IEEE	
			Register (Hex)	Words	Register (Hex)	Words
POWER HARMONICS & INTERHARMONICS - fnom=50 Hz						
Interharmonic Group 20 - Bin 4	03 / 04	0.001%/mW/mvar	1132	4	BC9A	2
Interharmonic Group 20 - Bin 5	03 / 04	0.001%/mW/mvar	1136	4	BC9C	2
Interharmonic Group 20 - Bin 6	03 / 04	0.001%/mW/mvar	113A	4	BC9E	2
Interharmonic Group 20 - Bin 7	03 / 04	0.001%/mW/mvar	113E	4	BCA0	2
Interharmonic Group 20 - Bin 8	03 / 04	0.001%/mW/mvar	1142	4	BCA2	2
Interharmonic Group 20 - Bin 9	03 / 04	0.001%/mW/mvar	1146	4	BCA4	2
21st Harmonic Component	03 / 04	0.001%/mW/mvar	114A	4	BCA6	2
Interharmonic Group 21 - Bin 1	03 / 04	0.001%/mW/mvar	114E	4	BCA8	2
Interharmonic Group 21 - Bin 2	03 / 04	0.001%/mW/mvar	1152	4	BCAA	2
Interharmonic Group 21 - Bin 3	03 / 04	0.001%/mW/mvar	1156	4	BCAC	2
Interharmonic Group 21 - Bin 4	03 / 04	0.001%/mW/mvar	115A	4	BCAE	2
Interharmonic Group 21 - Bin 5	03 / 04	0.001%/mW/mvar	115E	4	BCB0	2
Interharmonic Group 21 - Bin 6	03 / 04	0.001%/mW/mvar	1162	4	BCB2	2
Interharmonic Group 21 - Bin 7	03 / 04	0.001%/mW/mvar	1166	4	BCB4	2
Interharmonic Group 21 - Bin 8	03 / 04	0.001%/mW/mvar	116A	4	BCB6	2
Interharmonic Group 21 - Bin 9	03 / 04	0.001%/mW/mvar	116E	4	BCB8	2
22nd Harmonic Component	03 / 04	0.001%/mW/mvar	1172	4	BCBA	2
Interharmonic Group 22 - Bin 1	03 / 04	0.001%/mW/mvar	1176	4	BCBC	2
Interharmonic Group 22 - Bin 2	03 / 04	0.001%/mW/mvar	117A	4	BCBE	2
Interharmonic Group 22 - Bin 3	03 / 04	0.001%/mW/mvar	117E	4	BCC0	2
Interharmonic Group 22 - Bin 4	03 / 04	0.001%/mW/mvar	1182	4	BCC2	2
Interharmonic Group 22 - Bin 5	03 / 04	0.001%/mW/mvar	1186	4	BCC4	2
Interharmonic Group 22 - Bin 6	03 / 04	0.001%/mW/mvar	118A	4	BCC6	2
Interharmonic Group 22 - Bin 7	03 / 04	0.001%/mW/mvar	118E	4	BCC8	2
Interharmonic Group 22 - Bin 8	03 / 04	0.001%/mW/mvar	1192	4	BCCA	2
Interharmonic Group 22 - Bin 9	03 / 04	0.001%/mW/mvar	1196	4	BCCC	2
23rd Harmonic Component	03 / 04	0.001%/mW/mvar	119A	4	BCCE	2
Interharmonic Group 23 - Bin 1	03 / 04	0.001%/mW/mvar	119E	4	BCD0	2
Interharmonic Group 23 - Bin 2	03 / 04	0.001%/mW/mvar	11A2	4	BCD2	2
Interharmonic Group 23 - Bin 3	03 / 04	0.001%/mW/mvar	11A6	4	BCD4	2
Interharmonic Group 23 - Bin 4	03 / 04	0.001%/mW/mvar	11AA	4	BCD6	2
Interharmonic Group 23 - Bin 5	03 / 04	0.001%/mW/mvar	11AE	4	BCD8	2
Interharmonic Group 23 - Bin 6	03 / 04	0.001%/mW/mvar	11B2	4	BCDA	2
Interharmonic Group 23 - Bin 7	03 / 04	0.001%/mW/mvar	11B6	4	BCDC	2
Interharmonic Group 23 - Bin 8	03 / 04	0.001%/mW/mvar	11BA	4	BCDE	2
Interharmonic Group 23 - Bin 9	03 / 04	0.001%/mW/mvar	11BE	4	BCE0	2
24th Harmonic Component	03 / 04	0.001%/mW/mvar	11C2	4	BCE2	2
Interharmonic Group 24 - Bin 1	03 / 04	0.001%/mW/mvar	11C6	4	BCE4	2
Interharmonic Group 24 - Bin 2	03 / 04	0.001%/mW/mvar	11CA	4	BCE6	2
Interharmonic Group 24 - Bin 3	03 / 04	0.001%/mW/mvar	11CE	4	BCE8	2
Interharmonic Group 24 - Bin 4	03 / 04	0.001%/mW/mvar	11D2	4	BCEA	2
Interharmonic Group 24 - Bin 5	03 / 04	0.001%/mW/mvar	11D6	4	BCEC	2
Interharmonic Group 24 - Bin 6	03 / 04	0.001%/mW/mvar	11DA	4	BCEE	2
Interharmonic Group 24 - Bin 7	03 / 04	0.001%/mW/mvar	11DE	4	BCF0	2
Interharmonic Group 24 - Bin 8	03 / 04	0.001%/mW/mvar	11E2	4	BCF2	2
Interharmonic Group 24 - Bin 9	03 / 04	0.001%/mW/mvar	11E6	4	BCF4	2
25th Harmonic Component	03 / 04	0.001%/mW/mvar	11EA	4	BCF6	2
Interharmonic Group 25 - Bin 1	03 / 04	0.001%/mW/mvar	11EE	4	BCF8	2
Interharmonic Group 25 - Bin 2	03 / 04	0.001%/mW/mvar	11F2	4	BCFA	2
Interharmonic Group 25 - Bin 3	03 / 04	0.001%/mW/mvar	11F6	4	BCFC	2

Parameter	F. code (Hex)	M.U.	INTEGER		IEEE	
			Register (Hex)	Words	Register (Hex)	Words
POWER HARMONICS & INTERHARMONICS - fnom=50 Hz						
Interharmonic Group 25 - Bin 4	03 / 04	0.001%/mW/mvar	11FA	4	BCFE	2
Interharmonic Group 25 - Bin 5	03 / 04	0.001%/mW/mvar	11FE	4	BD00	2
Interharmonic Group 25 - Bin 6	03 / 04	0.001%/mW/mvar	1202	4	BD02	2
Interharmonic Group 25 - Bin 7	03 / 04	0.001%/mW/mvar	1206	4	BD04	2
Interharmonic Group 25 - Bin 8	03 / 04	0.001%/mW/mvar	120A	4	BD06	2
Interharmonic Group 25 - Bin 9	03 / 04	0.001%/mW/mvar	120E	4	BD08	2
26th Harmonic Component	03 / 04	0.001%/mW/mvar	1212	4	BD0A	2
Interharmonic Group 26 - Bin 1	03 / 04	0.001%/mW/mvar	1216	4	BD0C	2
Interharmonic Group 26 - Bin 2	03 / 04	0.001%/mW/mvar	121A	4	BD0E	2
Interharmonic Group 26 - Bin 3	03 / 04	0.001%/mW/mvar	121E	4	BD10	2
Interharmonic Group 26 - Bin 4	03 / 04	0.001%/mW/mvar	1222	4	BD12	2
Interharmonic Group 26 - Bin 5	03 / 04	0.001%/mW/mvar	1226	4	BD14	2
Interharmonic Group 26 - Bin 6	03 / 04	0.001%/mW/mvar	122A	4	BD16	2
Interharmonic Group 26 - Bin 7	03 / 04	0.001%/mW/mvar	122E	4	BD18	2
Interharmonic Group 26 - Bin 8	03 / 04	0.001%/mW/mvar	1232	4	BD1A	2
Interharmonic Group 26 - Bin 9	03 / 04	0.001%/mW/mvar	1236	4	BD1C	2
27th Harmonic Component	03 / 04	0.001%/mW/mvar	123A	4	BD1E	2
Interharmonic Group 27 - Bin 1	03 / 04	0.001%/mW/mvar	123E	4	BD20	2
Interharmonic Group 27 - Bin 2	03 / 04	0.001%/mW/mvar	1242	4	BD22	2
Interharmonic Group 27 - Bin 3	03 / 04	0.001%/mW/mvar	1246	4	BD24	2
Interharmonic Group 27 - Bin 4	03 / 04	0.001%/mW/mvar	124A	4	BD26	2
Interharmonic Group 27 - Bin 5	03 / 04	0.001%/mW/mvar	124E	4	BD28	2
Interharmonic Group 27 - Bin 6	03 / 04	0.001%/mW/mvar	1252	4	BD2A	2
Interharmonic Group 27 - Bin 7	03 / 04	0.001%/mW/mvar	1256	4	BD2C	2
Interharmonic Group 27 - Bin 8	03 / 04	0.001%/mW/mvar	125A	4	BD2E	2
Interharmonic Group 27 - Bin 9	03 / 04	0.001%/mW/mvar	125E	4	BD30	2
28th Harmonic Component	03 / 04	0.001%/mW/mvar	1262	4	BD32	2
Interharmonic Group 28 - Bin 1	03 / 04	0.001%/mW/mvar	1266	4	BD34	2
Interharmonic Group 28 - Bin 2	03 / 04	0.001%/mW/mvar	126A	4	BD36	2
Interharmonic Group 28 - Bin 3	03 / 04	0.001%/mW/mvar	126E	4	BD38	2
Interharmonic Group 28 - Bin 4	03 / 04	0.001%/mW/mvar	1272	4	BD3A	2
Interharmonic Group 28 - Bin 5	03 / 04	0.001%/mW/mvar	1276	4	BD3C	2
Interharmonic Group 28 - Bin 6	03 / 04	0.001%/mW/mvar	127A	4	BD3E	2
Interharmonic Group 28 - Bin 7	03 / 04	0.001%/mW/mvar	127E	4	BD40	2
Interharmonic Group 28 - Bin 8	03 / 04	0.001%/mW/mvar	1282	4	BD42	2
Interharmonic Group 28 - Bin 9	03 / 04	0.001%/mW/mvar	1286	4	BD44	2
29th Harmonic Component	03 / 04	0.001%/mW/mvar	128A	4	BD46	2
Interharmonic Group 29 - Bin 1	03 / 04	0.001%/mW/mvar	128E	4	BD48	2
Interharmonic Group 29 - Bin 2	03 / 04	0.001%/mW/mvar	1292	4	BD4A	2
Interharmonic Group 29 - Bin 3	03 / 04	0.001%/mW/mvar	1296	4	BD4C	2
Interharmonic Group 29 - Bin 4	03 / 04	0.001%/mW/mvar	129A	4	BD4E	2
Interharmonic Group 29 - Bin 5	03 / 04	0.001%/mW/mvar	129E	4	BD50	2
Interharmonic Group 29 - Bin 6	03 / 04	0.001%/mW/mvar	12A2	4	BD52	2
Interharmonic Group 29 - Bin 7	03 / 04	0.001%/mW/mvar	12A6	4	BD54	2
Interharmonic Group 29 - Bin 8	03 / 04	0.001%/mW/mvar	12AA	4	BD56	2
Interharmonic Group 29 - Bin 9	03 / 04	0.001%/mW/mvar	12AE	4	BD58	2
30th Harmonic Component	03 / 04	0.001%/mW/mvar	12B2	4	BD5A	2
Interharmonic Group 30 - Bin 1	03 / 04	0.001%/mW/mvar	12B6	4	BD5C	2
Interharmonic Group 30 - Bin 2	03 / 04	0.001%/mW/mvar	12BA	4	BD5E	2
Interharmonic Group 30 - Bin 3	03 / 04	0.001%/mW/mvar	12BE	4	BD60	2

Parameter	F. code (Hex)	M.U.	INTEGER		IEEE	
			Register (Hex)	Words	Register (Hex)	Words
POWER HARMONICS & INTERHARMONICS - fnom=50 Hz						
Interharmonic Group 30 - Bin 4	03 / 04	0.001%/mW/mvar	12C2	4	BD62	2
Interharmonic Group 30 - Bin 5	03 / 04	0.001%/mW/mvar	12C6	4	BD64	2
Interharmonic Group 30 - Bin 6	03 / 04	0.001%/mW/mvar	12CA	4	BD66	2
Interharmonic Group 30 - Bin 7	03 / 04	0.001%/mW/mvar	12CE	4	BD68	2
Interharmonic Group 30 - Bin 8	03 / 04	0.001%/mW/mvar	12D2	4	BD6A	2
Interharmonic Group 30 - Bin 9	03 / 04	0.001%/mW/mvar	12D6	4	BD6C	2
31st Harmonic Component	03 / 04	0.001%/mW/mvar	12DA	4	BD6E	2
Interharmonic Group 31 - Bin 1	03 / 04	0.001%/mW/mvar	12DE	4	BD70	2
Interharmonic Group 31 - Bin 2	03 / 04	0.001%/mW/mvar	12E2	4	BD72	2
Interharmonic Group 31 - Bin 3	03 / 04	0.001%/mW/mvar	12E6	4	BD74	2
Interharmonic Group 31 - Bin 4	03 / 04	0.001%/mW/mvar	12EA	4	BD76	2
Interharmonic Group 31 - Bin 5	03 / 04	0.001%/mW/mvar	12EE	4	BD78	2
Interharmonic Group 31 - Bin 6	03 / 04	0.001%/mW/mvar	12F2	4	BD7A	2
Interharmonic Group 31 - Bin 7	03 / 04	0.001%/mW/mvar	12F6	4	BD7C	2
Interharmonic Group 31 - Bin 8	03 / 04	0.001%/mW/mvar	12FA	4	BD7E	2
Interharmonic Group 31 - Bin 9	03 / 04	0.001%/mW/mvar	12FE	4	BD80	2
32nd Harmonic Component	03 / 04	0.001%/mW/mvar	1302	4	BD82	2
Interharmonic Group 32 - Bin 1	03 / 04	0.001%/mW/mvar	1306	4	BD84	2
Interharmonic Group 32 - Bin 2	03 / 04	0.001%/mW/mvar	130A	4	BD86	2
Interharmonic Group 32 - Bin 3	03 / 04	0.001%/mW/mvar	130E	4	BD88	2
Interharmonic Group 32 - Bin 4	03 / 04	0.001%/mW/mvar	1312	4	BD8A	2
Interharmonic Group 32 - Bin 5	03 / 04	0.001%/mW/mvar	1316	4	BD8C	2
Interharmonic Group 32 - Bin 6	03 / 04	0.001%/mW/mvar	131A	4	BD8E	2
Interharmonic Group 32 - Bin 7	03 / 04	0.001%/mW/mvar	131E	4	BD90	2
Interharmonic Group 32 - Bin 8	03 / 04	0.001%/mW/mvar	1322	4	BD92	2
Interharmonic Group 32 - Bin 9	03 / 04	0.001%/mW/mvar	1326	4	BD94	2
33rd Harmonic Component	03 / 04	0.001%/mW/mvar	132A	4	BD96	2
Interharmonic Group 33 - Bin 1	03 / 04	0.001%/mW/mvar	132E	4	BD98	2
Interharmonic Group 33 - Bin 2	03 / 04	0.001%/mW/mvar	1332	4	BD9A	2
Interharmonic Group 33 - Bin 3	03 / 04	0.001%/mW/mvar	1336	4	BD9C	2
Interharmonic Group 33 - Bin 4	03 / 04	0.001%/mW/mvar	133A	4	BD9E	2
Interharmonic Group 33 - Bin 5	03 / 04	0.001%/mW/mvar	133E	4	BDA0	2
Interharmonic Group 33 - Bin 6	03 / 04	0.001%/mW/mvar	1342	4	BDA2	2
Interharmonic Group 33 - Bin 7	03 / 04	0.001%/mW/mvar	1346	4	BDA4	2
Interharmonic Group 33 - Bin 8	03 / 04	0.001%/mW/mvar	134A	4	BDA6	2
Interharmonic Group 33 - Bin 9	03 / 04	0.001%/mW/mvar	134E	4	BDA8	2
34th Harmonic Component	03 / 04	0.001%/mW/mvar	1352	4	BDAA	2
Interharmonic Group 34 - Bin 1	03 / 04	0.001%/mW/mvar	1356	4	BDAC	2
Interharmonic Group 34 - Bin 2	03 / 04	0.001%/mW/mvar	135A	4	BDAE	2
Interharmonic Group 34 - Bin 3	03 / 04	0.001%/mW/mvar	135E	4	BDB0	2
Interharmonic Group 34 - Bin 4	03 / 04	0.001%/mW/mvar	1362	4	BDB2	2
Interharmonic Group 34 - Bin 5	03 / 04	0.001%/mW/mvar	1366	4	BDB4	2
Interharmonic Group 34 - Bin 6	03 / 04	0.001%/mW/mvar	136A	4	BDB6	2
Interharmonic Group 34 - Bin 7	03 / 04	0.001%/mW/mvar	136E	4	BDB8	2
Interharmonic Group 34 - Bin 8	03 / 04	0.001%/mW/mvar	1372	4	BD8A	2
Interharmonic Group 34 - Bin 9	03 / 04	0.001%/mW/mvar	1376	4	BDBC	2
35th Harmonic Component	03 / 04	0.001%/mW/mvar	137A	4	BDBE	2
Interharmonic Group 35 - Bin 1	03 / 04	0.001%/mW/mvar	137E	4	BDC0	2
Interharmonic Group 35 - Bin 2	03 / 04	0.001%/mW/mvar	1382	4	BDC2	2
Interharmonic Group 35 - Bin 3	03 / 04	0.001%/mW/mvar	1386	4	BDC4	2

Parameter	F. code (Hex)	M.U.	INTEGER		IEEE	
			Register (Hex)	Words	Register (Hex)	Words
POWER HARMONICS & INTERHARMONICS - fnom=50 Hz						
Interharmonic Group 35 - Bin 4	03 / 04	0.001%/mW/mvar	138A	4	BDC6	2
Interharmonic Group 35 - Bin 5	03 / 04	0.001%/mW/mvar	138E	4	BDC8	2
Interharmonic Group 35 - Bin 6	03 / 04	0.001%/mW/mvar	1392	4	BDCA	2
Interharmonic Group 35 - Bin 7	03 / 04	0.001%/mW/mvar	1396	4	BDCC	2
Interharmonic Group 35 - Bin 8	03 / 04	0.001%/mW/mvar	139A	4	BDCE	2
Interharmonic Group 35 - Bin 9	03 / 04	0.001%/mW/mvar	139E	4	BDD0	2
36th Harmonic Component	03 / 04	0.001%/mW/mvar	13A2	4	BDD2	2
Interharmonic Group 36 - Bin 1	03 / 04	0.001%/mW/mvar	13A6	4	BDD4	2
Interharmonic Group 36 - Bin 2	03 / 04	0.001%/mW/mvar	13AA	4	BDD6	2
Interharmonic Group 36 - Bin 3	03 / 04	0.001%/mW/mvar	13AE	4	BDD8	2
Interharmonic Group 36 - Bin 4	03 / 04	0.001%/mW/mvar	13B2	4	BDDA	2
Interharmonic Group 36 - Bin 5	03 / 04	0.001%/mW/mvar	13B6	4	BDDC	2
Interharmonic Group 36 - Bin 6	03 / 04	0.001%/mW/mvar	13BA	4	BDDE	2
Interharmonic Group 36 - Bin 7	03 / 04	0.001%/mW/mvar	13BE	4	BDE0	2
Interharmonic Group 36 - Bin 8	03 / 04	0.001%/mW/mvar	13C2	4	BDE2	2
Interharmonic Group 36 - Bin 9	03 / 04	0.001%/mW/mvar	13C6	4	BDE4	2
37th Harmonic Component	03 / 04	0.001%/mW/mvar	13CA	4	BDE6	2
Interharmonic Group 37 - Bin 1	03 / 04	0.001%/mW/mvar	13CE	4	BDE8	2
Interharmonic Group 37 - Bin 2	03 / 04	0.001%/mW/mvar	13D2	4	BDEA	2
Interharmonic Group 37 - Bin 3	03 / 04	0.001%/mW/mvar	13D6	4	BDEC	2
Interharmonic Group 37 - Bin 4	03 / 04	0.001%/mW/mvar	13DA	4	BDEE	2
Interharmonic Group 37 - Bin 5	03 / 04	0.001%/mW/mvar	13DE	4	BDF0	2
Interharmonic Group 37 - Bin 6	03 / 04	0.001%/mW/mvar	13E2	4	BDF2	2
Interharmonic Group 37 - Bin 7	03 / 04	0.001%/mW/mvar	13E6	4	BDF4	2
Interharmonic Group 37 - Bin 8	03 / 04	0.001%/mW/mvar	13EA	4	BDF6	2
Interharmonic Group 37 - Bin 9	03 / 04	0.001%/mW/mvar	13EE	4	BDF8	2
38th Harmonic Component	03 / 04	0.001%/mW/mvar	13F2	4	BDFA	2
Interharmonic Group 38 - Bin 1	03 / 04	0.001%/mW/mvar	13F6	4	BDFC	2
Interharmonic Group 38 - Bin 2	03 / 04	0.001%/mW/mvar	13FA	4	BDFE	2
Interharmonic Group 38 - Bin 3	03 / 04	0.001%/mW/mvar	13FE	4	BE00	2
Interharmonic Group 38 - Bin 4	03 / 04	0.001%/mW/mvar	1402	4	BE02	2
Interharmonic Group 38 - Bin 5	03 / 04	0.001%/mW/mvar	1406	4	BE04	2
Interharmonic Group 38 - Bin 6	03 / 04	0.001%/mW/mvar	140A	4	BE06	2
Interharmonic Group 38 - Bin 7	03 / 04	0.001%/mW/mvar	140E	4	BE08	2
Interharmonic Group 38 - Bin 8	03 / 04	0.001%/mW/mvar	1412	4	BE0A	2
Interharmonic Group 38 - Bin 9	03 / 04	0.001%/mW/mvar	1416	4	BE0C	2
39th Harmonic Component	03 / 04	0.001%/mW/mvar	141A	4	BE0E	2
Interharmonic Group 39 - Bin 1	03 / 04	0.001%/mW/mvar	141E	4	BE10	2
Interharmonic Group 39 - Bin 2	03 / 04	0.001%/mW/mvar	1422	4	BE12	2
Interharmonic Group 39 - Bin 3	03 / 04	0.001%/mW/mvar	1426	4	BE14	2
Interharmonic Group 39 - Bin 4	03 / 04	0.001%/mW/mvar	142A	4	BE16	2
Interharmonic Group 39 - Bin 5	03 / 04	0.001%/mW/mvar	142E	4	BE18	2
Interharmonic Group 39 - Bin 6	03 / 04	0.001%/mW/mvar	1432	4	BE1A	2
Interharmonic Group 39 - Bin 7	03 / 04	0.001%/mW/mvar	1436	4	BE1C	2
Interharmonic Group 39 - Bin 8	03 / 04	0.001%/mW/mvar	143A	4	BE1E	2
Interharmonic Group 39 - Bin 9	03 / 04	0.001%/mW/mvar	143E	4	BE20	2
40th Harmonic Component	03 / 04	0.001%/mW/mvar	1442	4	BE22	2
Interharmonic Group 40 - Bin 1	03 / 04	0.001%/mW/mvar	1446	4	BE24	2
Interharmonic Group 40 - Bin 2	03 / 04	0.001%/mW/mvar	144A	4	BE26	2
Interharmonic Group 40 - Bin 3	03 / 04	0.001%/mW/mvar	144E	4	BE28	2

Parameter	F. code (Hex)	M.U.	INTEGER		IEEE	
			Register (Hex)	Words	Register (Hex)	Words
POWER HARMONICS & INTERHARMONICS - fnom=50 Hz						
Interharmonic Group 40 - Bin 4	03 / 04	0.001%/mW/mvar	1452	4	BE2A	2
Interharmonic Group 40 - Bin 5	03 / 04	0.001%/mW/mvar	1456	4	BE2C	2
Interharmonic Group 40 - Bin 6	03 / 04	0.001%/mW/mvar	145A	4	BE2E	2
Interharmonic Group 40 - Bin 7	03 / 04	0.001%/mW/mvar	145E	4	BE30	2
Interharmonic Group 40 - Bin 8	03 / 04	0.001%/mW/mvar	1462	4	BE32	2
Interharmonic Group 40 - Bin 9	03 / 04	0.001%/mW/mvar	1466	4	BE34	2
41st Harmonic Component	03 / 04	0.001%/mW/mvar	146A	4	BE36	2
Interharmonic Group 41 - Bin 1	03 / 04	0.001%/mW/mvar	146E	4	BE38	2
Interharmonic Group 41 - Bin 2	03 / 04	0.001%/mW/mvar	1472	4	BE3A	2
Interharmonic Group 41 - Bin 3	03 / 04	0.001%/mW/mvar	1476	4	BE3C	2
Interharmonic Group 41 - Bin 4	03 / 04	0.001%/mW/mvar	147A	4	BE3E	2
Interharmonic Group 41 - Bin 5	03 / 04	0.001%/mW/mvar	147E	4	BE40	2
Interharmonic Group 41 - Bin 6	03 / 04	0.001%/mW/mvar	1482	4	BE42	2
Interharmonic Group 41 - Bin 7	03 / 04	0.001%/mW/mvar	1486	4	BE44	2
Interharmonic Group 41 - Bin 8	03 / 04	0.001%/mW/mvar	148A	4	BE46	2
Interharmonic Group 41 - Bin 9	03 / 04	0.001%/mW/mvar	148E	4	BE48	2
42nd Harmonic Component	03 / 04	0.001%/mW/mvar	1492	4	BE4A	2
Interharmonic Group 42 - Bin 1	03 / 04	0.001%/mW/mvar	1496	4	BE4C	2
Interharmonic Group 42 - Bin 2	03 / 04	0.001%/mW/mvar	149A	4	BE4E	2
Interharmonic Group 42 - Bin 3	03 / 04	0.001%/mW/mvar	149E	4	BE50	2
Interharmonic Group 42 - Bin 4	03 / 04	0.001%/mW/mvar	14A2	4	BE52	2
Interharmonic Group 42 - Bin 5	03 / 04	0.001%/mW/mvar	14A6	4	BE54	2
Interharmonic Group 42 - Bin 6	03 / 04	0.001%/mW/mvar	14AA	4	BE56	2
Interharmonic Group 42 - Bin 7	03 / 04	0.001%/mW/mvar	14AE	4	BE58	2
Interharmonic Group 42 - Bin 8	03 / 04	0.001%/mW/mvar	14B2	4	BE5A	2
Interharmonic Group 42 - Bin 9	03 / 04	0.001%/mW/mvar	14B6	4	BE5C	2
43rd Harmonic Component	03 / 04	0.001%/mW/mvar	14BA	4	BE5E	2
Interharmonic Group 43 - Bin 1	03 / 04	0.001%/mW/mvar	14BE	4	BE60	2
Interharmonic Group 43 - Bin 2	03 / 04	0.001%/mW/mvar	14C2	4	BE62	2
Interharmonic Group 43 - Bin 3	03 / 04	0.001%/mW/mvar	14C6	4	BE64	2
Interharmonic Group 43 - Bin 4	03 / 04	0.001%/mW/mvar	14CA	4	BE66	2
Interharmonic Group 43 - Bin 5	03 / 04	0.001%/mW/mvar	14CE	4	BE68	2
Interharmonic Group 43 - Bin 6	03 / 04	0.001%/mW/mvar	14D2	4	BE6A	2
Interharmonic Group 43 - Bin 7	03 / 04	0.001%/mW/mvar	14D6	4	BE6C	2
Interharmonic Group 43 - Bin 8	03 / 04	0.001%/mW/mvar	14DA	4	BE6E	2
Interharmonic Group 43 - Bin 9	03 / 04	0.001%/mW/mvar	14DE	4	BE70	2
44th Harmonic Component	03 / 04	0.001%/mW/mvar	14E2	4	BE72	2
Interharmonic Group 44 - Bin 1	03 / 04	0.001%/mW/mvar	14E6	4	BE74	2
Interharmonic Group 44 - Bin 2	03 / 04	0.001%/mW/mvar	14EA	4	BE76	2
Interharmonic Group 44 - Bin 3	03 / 04	0.001%/mW/mvar	14EE	4	BE78	2
Interharmonic Group 44 - Bin 4	03 / 04	0.001%/mW/mvar	14F2	4	BE7A	2
Interharmonic Group 44 - Bin 5	03 / 04	0.001%/mW/mvar	14F6	4	BE7C	2
Interharmonic Group 44 - Bin 6	03 / 04	0.001%/mW/mvar	14FA	4	BE7E	2
Interharmonic Group 44 - Bin 7	03 / 04	0.001%/mW/mvar	14FE	4	BE80	2
Interharmonic Group 44 - Bin 8	03 / 04	0.001%/mW/mvar	1502	4	BE82	2
Interharmonic Group 44 - Bin 9	03 / 04	0.001%/mW/mvar	1506	4	BE84	2
45th Harmonic Component	03 / 04	0.001%/mW/mvar	150A	4	BE86	2
Interharmonic Group 45 - Bin 1	03 / 04	0.001%/mW/mvar	150E	4	BE88	2
Interharmonic Group 45 - Bin 2	03 / 04	0.001%/mW/mvar	1512	4	BE8A	2
Interharmonic Group 45 - Bin 3	03 / 04	0.001%/mW/mvar	1516	4	BE8C	2

Parameter	F. code (Hex)	M.U.	INTEGER		IEEE	
			Register (Hex)	Words	Register (Hex)	Words
POWER HARMONICS & INTERHARMONICS - fnom=50 Hz						
Interharmonic Group 45 - Bin 4	03 / 04	0.001%/mW/mvar	151A	4	BE8E	2
Interharmonic Group 45 - Bin 5	03 / 04	0.001%/mW/mvar	151E	4	BE90	2
Interharmonic Group 45 - Bin 6	03 / 04	0.001%/mW/mvar	1522	4	BE92	2
Interharmonic Group 45 - Bin 7	03 / 04	0.001%/mW/mvar	1526	4	BE94	2
Interharmonic Group 45 - Bin 8	03 / 04	0.001%/mW/mvar	152A	4	BE96	2
Interharmonic Group 45 - Bin 9	03 / 04	0.001%/mW/mvar	152E	4	BE98	2
46th Harmonic Component	03 / 04	0.001%/mW/mvar	1532	4	BE9A	2
Interharmonic Group 46 - Bin 1	03 / 04	0.001%/mW/mvar	1536	4	BE9C	2
Interharmonic Group 46 - Bin 2	03 / 04	0.001%/mW/mvar	153A	4	BE9E	2
Interharmonic Group 46 - Bin 3	03 / 04	0.001%/mW/mvar	153E	4	BEA0	2
Interharmonic Group 46 - Bin 4	03 / 04	0.001%/mW/mvar	1542	4	BEA2	2
Interharmonic Group 46 - Bin 5	03 / 04	0.001%/mW/mvar	1546	4	BEA4	2
Interharmonic Group 46 - Bin 6	03 / 04	0.001%/mW/mvar	154A	4	BEA6	2
Interharmonic Group 46 - Bin 7	03 / 04	0.001%/mW/mvar	154E	4	BEA8	2
Interharmonic Group 46 - Bin 8	03 / 04	0.001%/mW/mvar	1552	4	BEAA	2
Interharmonic Group 46 - Bin 9	03 / 04	0.001%/mW/mvar	1556	4	BEAC	2
47th Harmonic Component	03 / 04	0.001%/mW/mvar	155A	4	BEAE	2
Interharmonic Group 47 - Bin 1	03 / 04	0.001%/mW/mvar	155E	4	BEB0	2
Interharmonic Group 47 - Bin 2	03 / 04	0.001%/mW/mvar	1562	4	BEB2	2
Interharmonic Group 47 - Bin 3	03 / 04	0.001%/mW/mvar	1566	4	BEB4	2
Interharmonic Group 47 - Bin 4	03 / 04	0.001%/mW/mvar	156A	4	BEB6	2
Interharmonic Group 47 - Bin 5	03 / 04	0.001%/mW/mvar	156E	4	BEB8	2
Interharmonic Group 47 - Bin 6	03 / 04	0.001%/mW/mvar	1572	4	BEBA	2
Interharmonic Group 47 - Bin 7	03 / 04	0.001%/mW/mvar	1576	4	BEBC	2
Interharmonic Group 47 - Bin 8	03 / 04	0.001%/mW/mvar	157A	4	BEBE	2
Interharmonic Group 47 - Bin 9	03 / 04	0.001%/mW/mvar	157E	4	BEC0	2
48th Harmonic Component	03 / 04	0.001%/mW/mvar	1582	4	BEC2	2
Interharmonic Group 48 - Bin 1	03 / 04	0.001%/mW/mvar	1586	4	BEC4	2
Interharmonic Group 48 - Bin 2	03 / 04	0.001%/mW/mvar	158A	4	BEC6	2
Interharmonic Group 48 - Bin 3	03 / 04	0.001%/mW/mvar	158E	4	BEC8	2
Interharmonic Group 48 - Bin 4	03 / 04	0.001%/mW/mvar	1592	4	BECA	2
Interharmonic Group 48 - Bin 5	03 / 04	0.001%/mW/mvar	1596	4	BECC	2
Interharmonic Group 48 - Bin 6	03 / 04	0.001%/mW/mvar	159A	4	BECE	2
Interharmonic Group 48 - Bin 7	03 / 04	0.001%/mW/mvar	159E	4	BED0	2
Interharmonic Group 48 - Bin 8	03 / 04	0.001%/mW/mvar	15A2	4	BED2	2
Interharmonic Group 48 - Bin 9	03 / 04	0.001%/mW/mvar	15A6	4	BED4	2
49th Harmonic Component	03 / 04	0.001%/mW/mvar	15AA	4	BED6	2
Interharmonic Group 49 - Bin 1	03 / 04	0.001%/mW/mvar	15AE	4	BED8	2
Interharmonic Group 49 - Bin 2	03 / 04	0.001%/mW/mvar	15B2	4	BEDA	2
Interharmonic Group 49 - Bin 3	03 / 04	0.001%/mW/mvar	15B6	4	BEDC	2
Interharmonic Group 49 - Bin 4	03 / 04	0.001%/mW/mvar	15BA	4	BEDE	2
Interharmonic Group 49 - Bin 5	03 / 04	0.001%/mW/mvar	15BE	4	BEE0	2
Interharmonic Group 49 - Bin 6	03 / 04	0.001%/mW/mvar	15C2	4	BEE2	2
Interharmonic Group 49 - Bin 7	03 / 04	0.001%/mW/mvar	15C6	4	BEE4	2
Interharmonic Group 49 - Bin 8	03 / 04	0.001%/mW/mvar	15CA	4	BEE6	2
Interharmonic Group 49 - Bin 9	03 / 04	0.001%/mW/mvar	15CE	4	BEE8	2
50th Harmonic Component	03 / 04	0.001%/mW/mvar	15D2	4	BEEA	2
Interharmonic Group 50 - Bin 1	03 / 04	0.001%/mW/mvar	15D6	4	BEEC	2
Interharmonic Group 50 - Bin 2	03 / 04	0.001%/mW/mvar	15DA	4	BEEE	2
Interharmonic Group 50 - Bin 3	03 / 04	0.001%/mW/mvar	15DE	4	BEF0	2

Parameter	F. code (Hex)	M.U.	INTEGER		IEEE	
			Register (Hex)	Words	Register (Hex)	Words
POWER HARMONICS & INTERHARMONICS - fnom=50 Hz						
Interharmonic Group 50 - Bin 4	03 / 04	0.001%/mW/mvar	15E2	4	BEF2	2
Interharmonic Group 50 - Bin 5	03 / 04	0.001%/mW/mvar	15E6	4	BEF4	2
Interharmonic Group 50 - Bin 6	03 / 04	0.001%/mW/mvar	15EA	4	BEF6	2
Interharmonic Group 50 - Bin 7	03 / 04	0.001%/mW/mvar	15EE	4	BEF8	2
Interharmonic Group 50 - Bin 8	03 / 04	0.001%/mW/mvar	15F2	4	BEFA	2
Interharmonic Group 50 - Bin 9	03 / 04	0.001%/mW/mvar	15F6	4	BEFC	2
51st Harmonic Component	03 / 04	0.001%/mW/mvar	15FA	4	BEFE	2
Interharmonic Group 51 - Bin 1	03 / 04	0.001%/mW/mvar	15FE	4	BF00	2
Interharmonic Group 51 - Bin 2	03 / 04	0.001%/mW/mvar	1602	4	BF02	2
Interharmonic Group 51 - Bin 3	03 / 04	0.001%/mW/mvar	1606	4	BF04	2
Interharmonic Group 51 - Bin 4	03 / 04	0.001%/mW/mvar	160A	4	BF06	2
Interharmonic Group 51 - Bin 5	03 / 04	0.001%/mW/mvar	160E	4	BF08	2
Interharmonic Group 51 - Bin 6	03 / 04	0.001%/mW/mvar	1612	4	BF0A	2
Interharmonic Group 51 - Bin 7	03 / 04	0.001%/mW/mvar	1616	4	BF0C	2
Interharmonic Group 51 - Bin 8	03 / 04	0.001%/mW/mvar	161A	4	BF0E	2
Interharmonic Group 51 - Bin 9	03 / 04	0.001%/mW/mvar	161E	4	BF10	2
52nd Harmonic Component	03 / 04	0.001%/mW/mvar	1622	4	BF12	2
Interharmonic Group 52 - Bin 1	03 / 04	0.001%/mW/mvar	1626	4	BF14	2
Interharmonic Group 52 - Bin 2	03 / 04	0.001%/mW/mvar	162A	4	BF16	2
Interharmonic Group 52 - Bin 3	03 / 04	0.001%/mW/mvar	162E	4	BF18	2
Interharmonic Group 52 - Bin 4	03 / 04	0.001%/mW/mvar	1632	4	BF1A	2
Interharmonic Group 52 - Bin 5	03 / 04	0.001%/mW/mvar	1636	4	BF1C	2
Interharmonic Group 52 - Bin 6	03 / 04	0.001%/mW/mvar	163A	4	BF1E	2
Interharmonic Group 52 - Bin 7	03 / 04	0.001%/mW/mvar	163E	4	BF20	2
Interharmonic Group 52 - Bin 8	03 / 04	0.001%/mW/mvar	1642	4	BF22	2
Interharmonic Group 52 - Bin 9	03 / 04	0.001%/mW/mvar	1646	4	BF24	2
53rd Harmonic Component	03 / 04	0.001%/mW/mvar	164A	4	BF26	2
Interharmonic Group 53 - Bin 1	03 / 04	0.001%/mW/mvar	164E	4	BF28	2
Interharmonic Group 53 - Bin 2	03 / 04	0.001%/mW/mvar	1652	4	BF2A	2
Interharmonic Group 53 - Bin 3	03 / 04	0.001%/mW/mvar	1656	4	BF2C	2
Interharmonic Group 53 - Bin 4	03 / 04	0.001%/mW/mvar	165A	4	BF2E	2
Interharmonic Group 53 - Bin 5	03 / 04	0.001%/mW/mvar	165E	4	BF30	2
Interharmonic Group 53 - Bin 6	03 / 04	0.001%/mW/mvar	1662	4	BF32	2
Interharmonic Group 53 - Bin 7	03 / 04	0.001%/mW/mvar	1666	4	BF34	2
Interharmonic Group 53 - Bin 8	03 / 04	0.001%/mW/mvar	166A	4	BF36	2
Interharmonic Group 53 - Bin 9	03 / 04	0.001%/mW/mvar	166E	4	BF38	2
54th Harmonic Component	03 / 04	0.001%/mW/mvar	1672	4	BF3A	2
Interharmonic Group 54 - Bin 1	03 / 04	0.001%/mW/mvar	1676	4	BF3C	2
Interharmonic Group 54 - Bin 2	03 / 04	0.001%/mW/mvar	167A	4	BF3E	2
Interharmonic Group 54 - Bin 3	03 / 04	0.001%/mW/mvar	167E	4	BF40	2
Interharmonic Group 54 - Bin 4	03 / 04	0.001%/mW/mvar	1682	4	BF42	2
Interharmonic Group 54 - Bin 5	03 / 04	0.001%/mW/mvar	1686	4	BF44	2
Interharmonic Group 54 - Bin 6	03 / 04	0.001%/mW/mvar	168A	4	BF46	2
Interharmonic Group 54 - Bin 7	03 / 04	0.001%/mW/mvar	168E	4	BF48	2
Interharmonic Group 54 - Bin 8	03 / 04	0.001%/mW/mvar	1692	4	BF4A	2
Interharmonic Group 54 - Bin 9	03 / 04	0.001%/mW/mvar	1696	4	BF4C	2
55th Harmonic Component	03 / 04	0.001%/mW/mvar	169A	4	BF4E	2
Interharmonic Group 55 - Bin 1	03 / 04	0.001%/mW/mvar	169E	4	BF50	2
Interharmonic Group 55 - Bin 2	03 / 04	0.001%/mW/mvar	16A2	4	BF52	2
Interharmonic Group 55 - Bin 3	03 / 04	0.001%/mW/mvar	16A6	4	BF54	2

Parameter	F. code (Hex)	M.U.	INTEGER		IEEE	
			Register (Hex)	Words	Register (Hex)	Words
POWER HARMONICS & INTERHARMONICS - fnom=50 Hz						
Interharmonic Group 55 - Bin 4	03 / 04	0.001%/mW/mvar	16AA	4	BF56	2
Interharmonic Group 55 - Bin 5	03 / 04	0.001%/mW/mvar	16AE	4	BF58	2
Interharmonic Group 55 - Bin 6	03 / 04	0.001%/mW/mvar	16B2	4	BF5A	2
Interharmonic Group 55 - Bin 7	03 / 04	0.001%/mW/mvar	16B6	4	BF5C	2
Interharmonic Group 55 - Bin 8	03 / 04	0.001%/mW/mvar	16BA	4	BF5E	2
Interharmonic Group 55 - Bin 9	03 / 04	0.001%/mW/mvar	16BE	4	BF60	2
56th Harmonic Component	03 / 04	0.001%/mW/mvar	16C2	4	BF62	2
Interharmonic Group 56 - Bin 1	03 / 04	0.001%/mW/mvar	16C6	4	BF64	2
Interharmonic Group 56 - Bin 2	03 / 04	0.001%/mW/mvar	16CA	4	BF66	2
Interharmonic Group 56 - Bin 3	03 / 04	0.001%/mW/mvar	16CE	4	BF68	2
Interharmonic Group 56 - Bin 4	03 / 04	0.001%/mW/mvar	16D2	4	BF6A	2
Interharmonic Group 56 - Bin 5	03 / 04	0.001%/mW/mvar	16D6	4	BF6C	2
Interharmonic Group 56 - Bin 6	03 / 04	0.001%/mW/mvar	16DA	4	BF6E	2
Interharmonic Group 56 - Bin 7	03 / 04	0.001%/mW/mvar	16DE	4	BF70	2
Interharmonic Group 56 - Bin 8	03 / 04	0.001%/mW/mvar	16E2	4	BF72	2
Interharmonic Group 56 - Bin 9	03 / 04	0.001%/mW/mvar	16E6	4	BF74	2
57th Harmonic Component	03 / 04	0.001%/mW/mvar	16EA	4	BF76	2
Interharmonic Group 57 - Bin 1	03 / 04	0.001%/mW/mvar	16EE	4	BF78	2
Interharmonic Group 57 - Bin 2	03 / 04	0.001%/mW/mvar	16F2	4	BF7A	2
Interharmonic Group 57 - Bin 3	03 / 04	0.001%/mW/mvar	16F6	4	BF7C	2
Interharmonic Group 57 - Bin 4	03 / 04	0.001%/mW/mvar	16FA	4	BF7E	2
Interharmonic Group 57 - Bin 5	03 / 04	0.001%/mW/mvar	16FE	4	BF80	2
Interharmonic Group 57 - Bin 6	03 / 04	0.001%/mW/mvar	1702	4	BF82	2
Interharmonic Group 57 - Bin 7	03 / 04	0.001%/mW/mvar	1706	4	BF84	2
Interharmonic Group 57 - Bin 8	03 / 04	0.001%/mW/mvar	170A	4	BF86	2
Interharmonic Group 57 - Bin 9	03 / 04	0.001%/mW/mvar	170E	4	BF88	2
58th Harmonic Component	03 / 04	0.001%/mW/mvar	1712	4	BF8A	2
Interharmonic Group 58 - Bin 1	03 / 04	0.001%/mW/mvar	1716	4	BF8C	2
Interharmonic Group 58 - Bin 2	03 / 04	0.001%/mW/mvar	171A	4	BF8E	2
Interharmonic Group 58 - Bin 3	03 / 04	0.001%/mW/mvar	171E	4	BF90	2
Interharmonic Group 58 - Bin 4	03 / 04	0.001%/mW/mvar	1722	4	BF92	2
Interharmonic Group 58 - Bin 5	03 / 04	0.001%/mW/mvar	1726	4	BF94	2
Interharmonic Group 58 - Bin 6	03 / 04	0.001%/mW/mvar	172A	4	BF96	2
Interharmonic Group 58 - Bin 7	03 / 04	0.001%/mW/mvar	172E	4	BF98	2
Interharmonic Group 58 - Bin 8	03 / 04	0.001%/mW/mvar	1732	4	BF9A	2
Interharmonic Group 58 - Bin 9	03 / 04	0.001%/mW/mvar	1736	4	BF9C	2
59th Harmonic Component	03 / 04	0.001%/mW/mvar	173A	4	BF9E	2
Interharmonic Group 59 - Bin 1	03 / 04	0.001%/mW/mvar	173E	4	BFA0	2
Interharmonic Group 59 - Bin 2	03 / 04	0.001%/mW/mvar	1742	4	BFA2	2
Interharmonic Group 59 - Bin 3	03 / 04	0.001%/mW/mvar	1746	4	BFA4	2
Interharmonic Group 59 - Bin 4	03 / 04	0.001%/mW/mvar	174A	4	BFA6	2
Interharmonic Group 59 - Bin 5	03 / 04	0.001%/mW/mvar	174E	4	BFA8	2
Interharmonic Group 59 - Bin 6	03 / 04	0.001%/mW/mvar	1752	4	BFAA	2
Interharmonic Group 59 - Bin 7	03 / 04	0.001%/mW/mvar	1756	4	BFAC	2
Interharmonic Group 59 - Bin 8	03 / 04	0.001%/mW/mvar	175A	4	BFAE	2
Interharmonic Group 59 - Bin 9	03 / 04	0.001%/mW/mvar	175E	4	BFB0	2
60th Harmonic Component	03 / 04	0.001%/mW/mvar	1762	4	BFB2	2
Interharmonic Group 60 - Bin 1	03 / 04	0.001%/mW/mvar	1766	4	BFB4	2
Interharmonic Group 60 - Bin 2	03 / 04	0.001%/mW/mvar	176A	4	BFB6	2
Interharmonic Group 60 - Bin 3	03 / 04	0.001%/mW/mvar	176E	4	BFB8	2

Parameter	F. code (Hex)	M.U.	INTEGER		IEEE	
			Register (Hex)	Words	Register (Hex)	Words
POWER HARMONICS & INTERHARMONICS - fnom=50 Hz						
Interharmonic Group 60 - Bin 4	03 / 04	0.001%/mW/mvar	1772	4	BFBA	2
Interharmonic Group 60 - Bin 5	03 / 04	0.001%/mW/mvar	1776	4	BFBC	2
Interharmonic Group 60 - Bin 6	03 / 04	0.001%/mW/mvar	177A	4	BFBE	2
Interharmonic Group 60 - Bin 7	03 / 04	0.001%/mW/mvar	177E	4	BFC0	2
Interharmonic Group 60 - Bin 8	03 / 04	0.001%/mW/mvar	1782	4	BFC2	2
Interharmonic Group 60 - Bin 9	03 / 04	0.001%/mW/mvar	1786	4	BFC4	2
61st Harmonic Component	03 / 04	0.001%/mW/mvar	178A	4	BFC6	2
Interharmonic Group 61 - Bin 1	03 / 04	0.001%/mW/mvar	178E	4	BFC8	2
Interharmonic Group 61 - Bin 2	03 / 04	0.001%/mW/mvar	1792	4	BFCA	2
Interharmonic Group 61 - Bin 3	03 / 04	0.001%/mW/mvar	1796	4	BFCC	2
Interharmonic Group 61 - Bin 4	03 / 04	0.001%/mW/mvar	179A	4	BFCE	2
Interharmonic Group 61 - Bin 5	03 / 04	0.001%/mW/mvar	179E	4	BFD0	2
Interharmonic Group 61 - Bin 6	03 / 04	0.001%/mW/mvar	17A2	4	BFD2	2
Interharmonic Group 61 - Bin 7	03 / 04	0.001%/mW/mvar	17A6	4	BFD4	2
Interharmonic Group 61 - Bin 8	03 / 04	0.001%/mW/mvar	17AA	4	BFD6	2
Interharmonic Group 61 - Bin 9	03 / 04	0.001%/mW/mvar	17AE	4	BFD8	2
62nd Harmonic Component	03 / 04	0.001%/mW/mvar	17B2	4	BFDA	2
Interharmonic Group 62 - Bin 1	03 / 04	0.001%/mW/mvar	17B6	4	BFDC	2
Interharmonic Group 62 - Bin 2	03 / 04	0.001%/mW/mvar	17BA	4	BFDE	2
Interharmonic Group 62 - Bin 3	03 / 04	0.001%/mW/mvar	17BE	4	BFE0	2
Interharmonic Group 62 - Bin 4	03 / 04	0.001%/mW/mvar	17C2	4	BFE2	2
Interharmonic Group 62 - Bin 5	03 / 04	0.001%/mW/mvar	17C6	4	BFE4	2
Interharmonic Group 62 - Bin 6	03 / 04	0.001%/mW/mvar	17CA	4	BFE6	2
Interharmonic Group 62 - Bin 7	03 / 04	0.001%/mW/mvar	17CE	4	BFE8	2
Interharmonic Group 62 - Bin 8	03 / 04	0.001%/mW/mvar	17D2	4	BFEA	2
Interharmonic Group 62 - Bin 9	03 / 04	0.001%/mW/mvar	17D6	4	BFEC	2
63rd Harmonic Component	03 / 04	0.001%/mW/mvar	17DA	4	BFEE	2
Interharmonic Group 63 - Bin 1	03 / 04	0.001%/mW/mvar	17DE	4	BFF0	2
Interharmonic Group 63 - Bin 2	03 / 04	0.001%/mW/mvar	17E2	4	BFF2	2
Interharmonic Group 63 - Bin 3	03 / 04	0.001%/mW/mvar	17E6	4	BFF4	2
Interharmonic Group 63 - Bin 4	03 / 04	0.001%/mW/mvar	17EA	4	BFF6	2
Interharmonic Group 63 - Bin 5	03 / 04	0.001%/mW/mvar	17EE	4	BFF8	2
Interharmonic Group 63 - Bin 6	03 / 04	0.001%/mW/mvar	17F2	4	BFFA	2
Interharmonic Group 63 - Bin 7	03 / 04	0.001%/mW/mvar	17F6	4	BFFC	2
Interharmonic Group 63 - Bin 8	03 / 04	0.001%/mW/mvar	17FA	4	BFFE	2
Interharmonic Group 63 - Bin 9	03 / 04	0.001%/mW/mvar	17FE	4	C000	2

Parameter	F. code (Hex)	M.U.	INTEGER		IEEE	
			Register (Hex)	Words	Register (Hex)	Words
POWER HARMONICS & INTERHARMONICS - fnom=60 Hz						
Set the parameter for the next reading command. Programmable data: \$01=Phase 1 Active Power (P1) \$02=Phase 2 Active Power (P2) \$03=Phase 3 Active Power (P3) \$04=Phase 1 Reactive Power (Q1) \$05=Phase 2 Reactive Power (Q2) \$06=Phase 3 Reactive Power (Q3) <u>Example</u> To read the Phase 1 active power fundamental (1st) integer: 1. First send writing register 0B00 by programming \$01 for parameter selection. 2. Then, send the reading register 0B32.	10	0.001	0B00	2	-	-
WARNING! The harmonic measuring unit changes according to the set display mode. If "Percentage" is set as display mode, the read harmonic will be in percentage values referred to the Fundamental. If "Absolute" is set as display mode, the read harmonic will be in absolute values (mW in case of active power harmonics or mvar in case of reactive power harmonics).						
DC Component	03 / 04	0.001%/mW/mvar	0E02	4	BB02	2
Interharmonic Group 0 - Bin 1	03 / 04	0.001%/mW/mvar	0E06	4	BB04	2
Interharmonic Group 0 - Bin 2	03 / 04	0.001%/mW/mvar	0E0A	4	BB06	2
Interharmonic Group 0 - Bin 3	03 / 04	0.001%/mW/mvar	0E0E	4	BB08	2
Interharmonic Group 0 - Bin 4	03 / 04	0.001%/mW/mvar	0E12	4	BB0A	2
Interharmonic Group 0 - Bin 5	03 / 04	0.001%/mW/mvar	0E16	4	BB0C	2
Interharmonic Group 0 - Bin 6	03 / 04	0.001%/mW/mvar	0E1A	4	BB0E	2
Interharmonic Group 0 - Bin 7	03 / 04	0.001%/mW/mvar	0E1E	4	BB10	2
Interharmonic Group 0 - Bin 8	03 / 04	0.001%/mW/mvar	0E22	4	BB12	2
Interharmonic Group 0 - Bin 9	03 / 04	0.001%/mW/mvar	0E26	4	BB14	2
Interharmonic Group 0 - Bin 10	03 / 04	0.001%/mW/mvar	0E2A	4	BB16	2
Interharmonic Group 0 - Bin 11	03 / 04	0.001%/mW/mvar	0E2E	4	BB18	2
1st Harmonic Component	03 / 04	0.001%/mW/mvar	0E32	4	BB1A	2
Interharmonic Group 1 - Bin 1	03 / 04	0.001%/mW/mvar	0E36	4	BB1C	2
Interharmonic Group 1 - Bin 2	03 / 04	0.001%/mW/mvar	0E3A	4	BB1E	2
Interharmonic Group 1 - Bin 3	03 / 04	0.001%/mW/mvar	0E3E	4	BB20	2
Interharmonic Group 1 - Bin 4	03 / 04	0.001%/mW/mvar	0E42	4	BB22	2
Interharmonic Group 1 - Bin 5	03 / 04	0.001%/mW/mvar	0E46	4	BB24	2
Interharmonic Group 1 - Bin 6	03 / 04	0.001%/mW/mvar	0E4A	4	BB26	2
Interharmonic Group 1 - Bin 7	03 / 04	0.001%/mW/mvar	0E4E	4	BB28	2
Interharmonic Group 1 - Bin 8	03 / 04	0.001%/mW/mvar	0E52	4	BB2A	2
Interharmonic Group 1 - Bin 9	03 / 04	0.001%/mW/mvar	0E56	4	BB2C	2
Interharmonic Group 1 - Bin 10	03 / 04	0.001%/mW/mvar	0E5A	4	BB2E	2
Interharmonic Group 1 - Bin 11	03 / 04	0.001%/mW/mvar	0E5E	4	BB30	2
2nd Harmonic Component	03 / 04	0.001%/mW/mvar	0E62	4	BB32	2
Interharmonic Group 2 - Bin 1	03 / 04	0.001%/mW/mvar	0E66	4	BB34	2
Interharmonic Group 2 - Bin 2	03 / 04	0.001%/mW/mvar	0E6A	4	BB36	2
Interharmonic Group 2 - Bin 3	03 / 04	0.001%/mW/mvar	0E6E	4	BB38	2
Interharmonic Group 2 - Bin 4	03 / 04	0.001%/mW/mvar	0E72	4	BB3A	2
Interharmonic Group 2 - Bin 5	03 / 04	0.001%/mW/mvar	0E76	4	BB3C	2
Interharmonic Group 2 - Bin 6	03 / 04	0.001%/mW/mvar	0E7A	4	BB3E	2
Interharmonic Group 2 - Bin 7	03 / 04	0.001%/mW/mvar	0E7E	4	BB40	2
Interharmonic Group 2 - Bin 8	03 / 04	0.001%/mW/mvar	0E82	4	BB42	2
Interharmonic Group 2 - Bin 9	03 / 04	0.001%/mW/mvar	0E86	4	BB44	2

Parameter	F. code (Hex)	M.U.	INTEGER		IEEE	
			Register (Hex)	Words	Register (Hex)	Words
POWER HARMONICS & INTERHARMONICS - fnom=60 Hz						
Interharmonic Group 2 - Bin 10	03 / 04	0.001%/mW/mvar	0E8A	4	BB46	2
Interharmonic Group 2 - Bin 11	03 / 04	0.001%/mW/mvar	0E8E	4	BB48	2
3rd Harmonic Component	03 / 04	0.001%/mW/mvar	0E92	4	BB4A	2
Interharmonic Group 3 - Bin 1	03 / 04	0.001%/mW/mvar	0E96	4	BB4C	2
Interharmonic Group 3 - Bin 2	03 / 04	0.001%/mW/mvar	0E9A	4	BB4E	2
Interharmonic Group 3 - Bin 3	03 / 04	0.001%/mW/mvar	0E9E	4	BB50	2
Interharmonic Group 3 - Bin 4	03 / 04	0.001%/mW/mvar	0EA2	4	BB52	2
Interharmonic Group 3 - Bin 5	03 / 04	0.001%/mW/mvar	0EA6	4	BB54	2
Interharmonic Group 3 - Bin 6	03 / 04	0.001%/mW/mvar	0EAA	4	BB56	2
Interharmonic Group 3 - Bin 7	03 / 04	0.001%/mW/mvar	0EAE	4	BB58	2
Interharmonic Group 3 - Bin 8	03 / 04	0.001%/mW/mvar	0EB2	4	BB5A	2
Interharmonic Group 3 - Bin 9	03 / 04	0.001%/mW/mvar	0EB6	4	BB5C	2
Interharmonic Group 3 - Bin 10	03 / 04	0.001%/mW/mvar	0EBA	4	BB5E	2
Interharmonic Group 3 - Bin 11	03 / 04	0.001%/mW/mvar	0EBE	4	BB60	2
4th Harmonic Component	03 / 04	0.001%/mW/mvar	0EC2	4	BB62	2
Interharmonic Group 4 - Bin 1	03 / 04	0.001%/mW/mvar	0EC6	4	BB64	2
Interharmonic Group 4 - Bin 2	03 / 04	0.001%/mW/mvar	0ECA	4	BB66	2
Interharmonic Group 4 - Bin 3	03 / 04	0.001%/mW/mvar	0ECE	4	BB68	2
Interharmonic Group 4 - Bin 4	03 / 04	0.001%/mW/mvar	0ED2	4	BB6A	2
Interharmonic Group 4 - Bin 5	03 / 04	0.001%/mW/mvar	0ED6	4	BB6C	2
Interharmonic Group 4 - Bin 6	03 / 04	0.001%/mW/mvar	0EDA	4	BB6E	2
Interharmonic Group 4 - Bin 7	03 / 04	0.001%/mW/mvar	0EDE	4	BB70	2
Interharmonic Group 4 - Bin 8	03 / 04	0.001%/mW/mvar	0EE2	4	BB72	2
Interharmonic Group 4 - Bin 9	03 / 04	0.001%/mW/mvar	0EE6	4	BB74	2
Interharmonic Group 4 - Bin 10	03 / 04	0.001%/mW/mvar	0EEA	4	BB76	2
Interharmonic Group 4 - Bin 11	03 / 04	0.001%/mW/mvar	0EEE	4	BB78	2
5th Harmonic Component	03 / 04	0.001%/mW/mvar	0EF2	4	BB7A	2
Interharmonic Group 5 - Bin 1	03 / 04	0.001%/mW/mvar	0EF6	4	BB7C	2
Interharmonic Group 5 - Bin 2	03 / 04	0.001%/mW/mvar	0EFA	4	BB7E	2
Interharmonic Group 5 - Bin 3	03 / 04	0.001%/mW/mvar	0EFE	4	BB80	2
Interharmonic Group 5 - Bin 4	03 / 04	0.001%/mW/mvar	0F02	4	BB82	2
Interharmonic Group 5 - Bin 5	03 / 04	0.001%/mW/mvar	0F06	4	BB84	2
Interharmonic Group 5 - Bin 6	03 / 04	0.001%/mW/mvar	0F0A	4	BB86	2
Interharmonic Group 5 - Bin 7	03 / 04	0.001%/mW/mvar	0F0E	4	BB88	2
Interharmonic Group 5 - Bin 8	03 / 04	0.001%/mW/mvar	0F12	4	BB8A	2
Interharmonic Group 5 - Bin 9	03 / 04	0.001%/mW/mvar	0F16	4	BB8C	2
Interharmonic Group 5 - Bin 10	03 / 04	0.001%/mW/mvar	0F1A	4	BB8E	2
Interharmonic Group 5 - Bin 11	03 / 04	0.001%/mW/mvar	0F1E	4	BB90	2
6th Harmonic Component	03 / 04	0.001%/mW/mvar	0F22	4	BB92	2
Interharmonic Group 6 - Bin 1	03 / 04	0.001%/mW/mvar	0F26	4	BB94	2
Interharmonic Group 6 - Bin 2	03 / 04	0.001%/mW/mvar	0F2A	4	BB96	2
Interharmonic Group 6 - Bin 3	03 / 04	0.001%/mW/mvar	0F2E	4	BB98	2
Interharmonic Group 6 - Bin 4	03 / 04	0.001%/mW/mvar	0F32	4	BB9A	2
Interharmonic Group 6 - Bin 5	03 / 04	0.001%/mW/mvar	0F36	4	BB9C	2
Interharmonic Group 6 - Bin 6	03 / 04	0.001%/mW/mvar	0F3A	4	BB9E	2
Interharmonic Group 6 - Bin 7	03 / 04	0.001%/mW/mvar	0F3E	4	BBA0	2
Interharmonic Group 6 - Bin 8	03 / 04	0.001%/mW/mvar	0F42	4	BBA2	2
Interharmonic Group 6 - Bin 9	03 / 04	0.001%/mW/mvar	0F46	4	BBA4	2
Interharmonic Group 6 - Bin 10	03 / 04	0.001%/mW/mvar	0F4A	4	BBA6	2
Interharmonic Group 6 - Bin 11	03 / 04	0.001%/mW/mvar	0F4E	4	BBA8	2

Parameter	F. code (Hex)	M.U.	INTEGER		IEEE	
			Register (Hex)	Words	Register (Hex)	Words
POWER HARMONICS & INTERHARMONICS - fnom=60 Hz						
7th Harmonic Component	03 / 04	0.001%/mW/mvar	0F52	4	BBAA	2
Interharmonic Group 7 - Bin 1	03 / 04	0.001%/mW/mvar	0F56	4	BBAC	2
Interharmonic Group 7 - Bin 2	03 / 04	0.001%/mW/mvar	0F5A	4	BBAE	2
Interharmonic Group 7 - Bin 3	03 / 04	0.001%/mW/mvar	0F5E	4	BBB0	2
Interharmonic Group 7 - Bin 4	03 / 04	0.001%/mW/mvar	0F62	4	BBB2	2
Interharmonic Group 7 - Bin 5	03 / 04	0.001%/mW/mvar	0F66	4	BBB4	2
Interharmonic Group 7 - Bin 6	03 / 04	0.001%/mW/mvar	0F6A	4	BBB6	2
Interharmonic Group 7 - Bin 7	03 / 04	0.001%/mW/mvar	0F6E	4	BBB8	2
Interharmonic Group 7 - Bin 8	03 / 04	0.001%/mW/mvar	0F72	4	BBBA	2
Interharmonic Group 7 - Bin 9	03 / 04	0.001%/mW/mvar	0F76	4	BBBC	2
Interharmonic Group 7 - Bin 10	03 / 04	0.001%/mW/mvar	0F7A	4	BBBE	2
Interharmonic Group 7 - Bin 11	03 / 04	0.001%/mW/mvar	0F7E	4	BBC0	2
8th Harmonic Component	03 / 04	0.001%/mW/mvar	0F82	4	BBC2	2
Interharmonic Group 8 - Bin 1	03 / 04	0.001%/mW/mvar	0F86	4	BBC4	2
Interharmonic Group 8 - Bin 2	03 / 04	0.001%/mW/mvar	0F8A	4	BBC6	2
Interharmonic Group 8 - Bin 3	03 / 04	0.001%/mW/mvar	0F8E	4	BBC8	2
Interharmonic Group 8 - Bin 4	03 / 04	0.001%/mW/mvar	0F92	4	BBCA	2
Interharmonic Group 8 - Bin 5	03 / 04	0.001%/mW/mvar	0F96	4	BBCC	2
Interharmonic Group 8 - Bin 6	03 / 04	0.001%/mW/mvar	0F9A	4	BBCE	2
Interharmonic Group 8 - Bin 7	03 / 04	0.001%/mW/mvar	0F9E	4	BBD0	2
Interharmonic Group 8 - Bin 8	03 / 04	0.001%/mW/mvar	0FA2	4	BBD2	2
Interharmonic Group 8 - Bin 9	03 / 04	0.001%/mW/mvar	0FA6	4	BBD4	2
Interharmonic Group 8 - Bin 10	03 / 04	0.001%/mW/mvar	0FAA	4	BBD6	2
Interharmonic Group 8 - Bin 11	03 / 04	0.001%/mW/mvar	0FAE	4	BBD8	2
9th Harmonic Component	03 / 04	0.001%/mW/mvar	0FB2	4	BBDA	2
Interharmonic Group 9 - Bin 1	03 / 04	0.001%/mW/mvar	0FB6	4	BBDC	2
Interharmonic Group 9 - Bin 2	03 / 04	0.001%/mW/mvar	0FBA	4	BBDE	2
Interharmonic Group 9 - Bin 3	03 / 04	0.001%/mW/mvar	0FBE	4	BBE0	2
Interharmonic Group 9 - Bin 4	03 / 04	0.001%/mW/mvar	0FC2	4	BBE2	2
Interharmonic Group 9 - Bin 5	03 / 04	0.001%/mW/mvar	0FC6	4	BBE4	2
Interharmonic Group 9 - Bin 6	03 / 04	0.001%/mW/mvar	0FCA	4	BBE6	2
Interharmonic Group 9 - Bin 7	03 / 04	0.001%/mW/mvar	0FCE	4	BBE8	2
Interharmonic Group 9 - Bin 8	03 / 04	0.001%/mW/mvar	0FD2	4	BBEA	2
Interharmonic Group 9 - Bin 9	03 / 04	0.001%/mW/mvar	0FD6	4	BBEC	2
Interharmonic Group 9 - Bin 10	03 / 04	0.001%/mW/mvar	0FDA	4	BBEE	2
Interharmonic Group 9 - Bin 11	03 / 04	0.001%/mW/mvar	0FDE	4	BBF0	2
10th Harmonic Component	03 / 04	0.001%/mW/mvar	0FE2	4	BBF2	2
Interharmonic Group 10 - Bin 1	03 / 04	0.001%/mW/mvar	0FE6	4	BBF4	2
Interharmonic Group 10 - Bin 2	03 / 04	0.001%/mW/mvar	0FEA	4	BBF6	2
Interharmonic Group 10 - Bin 3	03 / 04	0.001%/mW/mvar	0FEE	4	BBF8	2
Interharmonic Group 10 - Bin 4	03 / 04	0.001%/mW/mvar	0FF2	4	BBFA	2
Interharmonic Group 10 - Bin 5	03 / 04	0.001%/mW/mvar	0FF6	4	BBFC	2
Interharmonic Group 10 - Bin 6	03 / 04	0.001%/mW/mvar	0FFA	4	BBFE	2
Interharmonic Group 10 - Bin 7	03 / 04	0.001%/mW/mvar	0FFE	4	BC00	2
Interharmonic Group 10 - Bin 8	03 / 04	0.001%/mW/mvar	1002	4	BC02	2
Interharmonic Group 10 - Bin 9	03 / 04	0.001%/mW/mvar	1006	4	BC04	2
Interharmonic Group 10 - Bin 10	03 / 04	0.001%/mW/mvar	100A	4	BC06	2
Interharmonic Group 10 - Bin 11	03 / 04	0.001%/mW/mvar	100E	4	BC08	2
11th Harmonic Component	03 / 04	0.001%/mW/mvar	1012	4	BC0A	2
Interharmonic Group 11 - Bin 1	03 / 04	0.001%/mW/mvar	1016	4	BC0C	2

Parameter	F. code (Hex)	M.U.	INTEGER		IEEE	
			Register (Hex)	Words	Register (Hex)	Words
POWER HARMONICS & INTERHARMONICS - fnom=60 Hz						
Interharmonic Group 11 - Bin 2	03 / 04	0.001%/mW/mvar	101A	4	BC0E	2
Interharmonic Group 11 - Bin 3	03 / 04	0.001%/mW/mvar	101E	4	BC10	2
Interharmonic Group 11 - Bin 4	03 / 04	0.001%/mW/mvar	1022	4	BC12	2
Interharmonic Group 11 - Bin 5	03 / 04	0.001%/mW/mvar	1026	4	BC14	2
Interharmonic Group 11 - Bin 6	03 / 04	0.001%/mW/mvar	102A	4	BC16	2
Interharmonic Group 11 - Bin 7	03 / 04	0.001%/mW/mvar	102E	4	BC18	2
Interharmonic Group 11 - Bin 8	03 / 04	0.001%/mW/mvar	1032	4	BC1A	2
Interharmonic Group 11 - Bin 9	03 / 04	0.001%/mW/mvar	1036	4	BC1C	2
Interharmonic Group 11 - Bin 10	03 / 04	0.001%/mW/mvar	103A	4	BC1E	2
Interharmonic Group 11 - Bin 11	03 / 04	0.001%/mW/mvar	103E	4	BC20	2
12th Harmonic Component	03 / 04	0.001%/mW/mvar	1042	4	BC22	2
Interharmonic Group 12 - Bin 1	03 / 04	0.001%/mW/mvar	1046	4	BC24	2
Interharmonic Group 12 - Bin 2	03 / 04	0.001%/mW/mvar	104A	4	BC26	2
Interharmonic Group 12 - Bin 3	03 / 04	0.001%/mW/mvar	104E	4	BC28	2
Interharmonic Group 12 - Bin 4	03 / 04	0.001%/mW/mvar	1052	4	BC2A	2
Interharmonic Group 12 - Bin 5	03 / 04	0.001%/mW/mvar	1056	4	BC2C	2
Interharmonic Group 12 - Bin 6	03 / 04	0.001%/mW/mvar	105A	4	BC2E	2
Interharmonic Group 12 - Bin 7	03 / 04	0.001%/mW/mvar	105E	4	BC30	2
Interharmonic Group 12 - Bin 8	03 / 04	0.001%/mW/mvar	1062	4	BC32	2
Interharmonic Group 12 - Bin 9	03 / 04	0.001%/mW/mvar	1066	4	BC34	2
Interharmonic Group 12 - Bin 10	03 / 04	0.001%/mW/mvar	106A	4	BC36	2
Interharmonic Group 12 - Bin 11	03 / 04	0.001%/mW/mvar	106E	4	BC38	2
13th Harmonic Component	03 / 04	0.001%/mW/mvar	1072	4	BC3A	2
Interharmonic Group 13 - Bin 1	03 / 04	0.001%/mW/mvar	1076	4	BC3C	2
Interharmonic Group 13 - Bin 2	03 / 04	0.001%/mW/mvar	107A	4	BC3E	2
Interharmonic Group 13 - Bin 3	03 / 04	0.001%/mW/mvar	107E	4	BC40	2
Interharmonic Group 13 - Bin 4	03 / 04	0.001%/mW/mvar	1082	4	BC42	2
Interharmonic Group 13 - Bin 5	03 / 04	0.001%/mW/mvar	1086	4	BC44	2
Interharmonic Group 13 - Bin 6	03 / 04	0.001%/mW/mvar	108A	4	BC46	2
Interharmonic Group 13 - Bin 7	03 / 04	0.001%/mW/mvar	108E	4	BC48	2
Interharmonic Group 13 - Bin 8	03 / 04	0.001%/mW/mvar	1092	4	BC4A	2
Interharmonic Group 13 - Bin 9	03 / 04	0.001%/mW/mvar	1096	4	BC4C	2
Interharmonic Group 13 - Bin 10	03 / 04	0.001%/mW/mvar	109A	4	BC4E	2
Interharmonic Group 13 - Bin 11	03 / 04	0.001%/mW/mvar	109E	4	BC50	2
14th Harmonic Component	03 / 04	0.001%/mW/mvar	10A2	4	BC52	2
Interharmonic Group 14 - Bin 1	03 / 04	0.001%/mW/mvar	10A6	4	BC54	2
Interharmonic Group 14 - Bin 2	03 / 04	0.001%/mW/mvar	10AA	4	BC56	2
Interharmonic Group 14 - Bin 3	03 / 04	0.001%/mW/mvar	10AE	4	BC58	2
Interharmonic Group 14 - Bin 4	03 / 04	0.001%/mW/mvar	10B2	4	BC5A	2
Interharmonic Group 14 - Bin 5	03 / 04	0.001%/mW/mvar	10B6	4	BC5C	2
Interharmonic Group 14 - Bin 6	03 / 04	0.001%/mW/mvar	10BA	4	BC5E	2
Interharmonic Group 14 - Bin 7	03 / 04	0.001%/mW/mvar	10BE	4	BC60	2
Interharmonic Group 14 - Bin 8	03 / 04	0.001%/mW/mvar	10C2	4	BC62	2
Interharmonic Group 14 - Bin 9	03 / 04	0.001%/mW/mvar	10C6	4	BC64	2
Interharmonic Group 14 - Bin 10	03 / 04	0.001%/mW/mvar	10CA	4	BC66	2
Interharmonic Group 14 - Bin 11	03 / 04	0.001%/mW/mvar	10CE	4	BC68	2
15th Harmonic Component	03 / 04	0.001%/mW/mvar	10D2	4	BC6A	2
Interharmonic Group 15 - Bin 1	03 / 04	0.001%/mW/mvar	10D6	4	BC6C	2
Interharmonic Group 15 - Bin 2	03 / 04	0.001%/mW/mvar	10DA	4	BC6E	2
Interharmonic Group 15 - Bin 3	03 / 04	0.001%/mW/mvar	10DE	4	BC70	2

Parameter	F. code (Hex)	M.U.	INTEGER		IEEE	
			Register (Hex)	Words	Register (Hex)	Words
POWER HARMONICS & INTERHARMONICS - fnom=60 Hz						
Interharmonic Group 15 - Bin 4	03 / 04	0.001%/mW/mvar	10E2	4	BC72	2
Interharmonic Group 15 - Bin 5	03 / 04	0.001%/mW/mvar	10E6	4	BC74	2
Interharmonic Group 15 - Bin 6	03 / 04	0.001%/mW/mvar	10EA	4	BC76	2
Interharmonic Group 15 - Bin 7	03 / 04	0.001%/mW/mvar	10EE	4	BC78	2
Interharmonic Group 15 - Bin 8	03 / 04	0.001%/mW/mvar	10F2	4	BC7A	2
Interharmonic Group 15 - Bin 9	03 / 04	0.001%/mW/mvar	10F6	4	BC7C	2
Interharmonic Group 15 - Bin 10	03 / 04	0.001%/mW/mvar	10FA	4	BC7E	2
Interharmonic Group 15 - Bin 11	03 / 04	0.001%/mW/mvar	10FE	4	BC80	2
16th Harmonic Component	03 / 04	0.001%/mW/mvar	1102	4	BC82	2
Interharmonic Group 16 - Bin 1	03 / 04	0.001%/mW/mvar	1106	4	BC84	2
Interharmonic Group 16 - Bin 2	03 / 04	0.001%/mW/mvar	110A	4	BC86	2
Interharmonic Group 16 - Bin 3	03 / 04	0.001%/mW/mvar	110E	4	BC88	2
Interharmonic Group 16 - Bin 4	03 / 04	0.001%/mW/mvar	1112	4	BC8A	2
Interharmonic Group 16 - Bin 5	03 / 04	0.001%/mW/mvar	1116	4	BC8C	2
Interharmonic Group 16 - Bin 6	03 / 04	0.001%/mW/mvar	111A	4	BC8E	2
Interharmonic Group 16 - Bin 7	03 / 04	0.001%/mW/mvar	111E	4	BC90	2
Interharmonic Group 16 - Bin 8	03 / 04	0.001%/mW/mvar	1122	4	BC92	2
Interharmonic Group 16 - Bin 9	03 / 04	0.001%/mW/mvar	1126	4	BC94	2
Interharmonic Group 16 - Bin 10	03 / 04	0.001%/mW/mvar	112A	4	BC96	2
Interharmonic Group 16 - Bin 11	03 / 04	0.001%/mW/mvar	112E	4	BC98	2
17th Harmonic Component	03 / 04	0.001%/mW/mvar	1132	4	BC9A	2
Interharmonic Group 17 - Bin 1	03 / 04	0.001%/mW/mvar	1136	4	BC9C	2
Interharmonic Group 17 - Bin 2	03 / 04	0.001%/mW/mvar	113A	4	BC9E	2
Interharmonic Group 17 - Bin 3	03 / 04	0.001%/mW/mvar	113E	4	BCA0	2
Interharmonic Group 17 - Bin 4	03 / 04	0.001%/mW/mvar	1142	4	BCA2	2
Interharmonic Group 17 - Bin 5	03 / 04	0.001%/mW/mvar	1146	4	BCA4	2
Interharmonic Group 17 - Bin 6	03 / 04	0.001%/mW/mvar	114A	4	BCA6	2
Interharmonic Group 17 - Bin 7	03 / 04	0.001%/mW/mvar	114E	4	BCA8	2
Interharmonic Group 17 - Bin 8	03 / 04	0.001%/mW/mvar	1152	4	BCAA	2
Interharmonic Group 17 - Bin 9	03 / 04	0.001%/mW/mvar	1156	4	BCAC	2
Interharmonic Group 17 - Bin 10	03 / 04	0.001%/mW/mvar	115A	4	BCAE	2
Interharmonic Group 17 - Bin 11	03 / 04	0.001%/mW/mvar	115E	4	BCB0	2
18th Harmonic Component	03 / 04	0.001%/mW/mvar	1162	4	BCB2	2
Interharmonic Group 18 - Bin 1	03 / 04	0.001%/mW/mvar	1166	4	BCB4	2
Interharmonic Group 18 - Bin 2	03 / 04	0.001%/mW/mvar	116A	4	BCB6	2
Interharmonic Group 18 - Bin 3	03 / 04	0.001%/mW/mvar	116E	4	BCB8	2
Interharmonic Group 18 - Bin 4	03 / 04	0.001%/mW/mvar	1172	4	BCBA	2
Interharmonic Group 18 - Bin 5	03 / 04	0.001%/mW/mvar	1176	4	BCBC	2
Interharmonic Group 18 - Bin 6	03 / 04	0.001%/mW/mvar	117A	4	BCBE	2
Interharmonic Group 18 - Bin 7	03 / 04	0.001%/mW/mvar	117E	4	BCC0	2
Interharmonic Group 18 - Bin 8	03 / 04	0.001%/mW/mvar	1182	4	BCC2	2
Interharmonic Group 18 - Bin 9	03 / 04	0.001%/mW/mvar	1186	4	BCC4	2
Interharmonic Group 18 - Bin 10	03 / 04	0.001%/mW/mvar	118A	4	BCC6	2
Interharmonic Group 18 - Bin 11	03 / 04	0.001%/mW/mvar	118E	4	BCC8	2
19th Harmonic Component	03 / 04	0.001%/mW/mvar	1192	4	BCCA	2
Interharmonic Group 19 - Bin 1	03 / 04	0.001%/mW/mvar	1196	4	BCCC	2
Interharmonic Group 19 - Bin 2	03 / 04	0.001%/mW/mvar	119A	4	BCCE	2
Interharmonic Group 19 - Bin 3	03 / 04	0.001%/mW/mvar	119E	4	BCD0	2
Interharmonic Group 19 - Bin 4	03 / 04	0.001%/mW/mvar	11A2	4	BCD2	2
Interharmonic Group 19 - Bin 5	03 / 04	0.001%/mW/mvar	11A6	4	BCD4	2

Parameter	F. code (Hex)	M.U.	INTEGER		IEEE	
			Register (Hex)	Words	Register (Hex)	Words
POWER HARMONICS & INTERHARMONICS - fnom=60 Hz						
Interharmonic Group 19 - Bin 6	03 / 04	0.001%/mW/mvar	11AA	4	BCD6	2
Interharmonic Group 19 - Bin 7	03 / 04	0.001%/mW/mvar	11AE	4	BCD8	2
Interharmonic Group 19 - Bin 8	03 / 04	0.001%/mW/mvar	11B2	4	BCDA	2
Interharmonic Group 19 - Bin 9	03 / 04	0.001%/mW/mvar	11B6	4	BCDC	2
Interharmonic Group 19 - Bin 10	03 / 04	0.001%/mW/mvar	11BA	4	BCDE	2
Interharmonic Group 19 - Bin 11	03 / 04	0.001%/mW/mvar	11BE	4	BCE0	2
20th Harmonic Component	03 / 04	0.001%/mW/mvar	11C2	4	BCE2	2
Interharmonic Group 20 - Bin 1	03 / 04	0.001%/mW/mvar	11C6	4	BCE4	2
Interharmonic Group 20 - Bin 2	03 / 04	0.001%/mW/mvar	11CA	4	BCE6	2
Interharmonic Group 20 - Bin 3	03 / 04	0.001%/mW/mvar	11CE	4	BCE8	2
Interharmonic Group 20 - Bin 4	03 / 04	0.001%/mW/mvar	11D2	4	BCEA	2
Interharmonic Group 20 - Bin 5	03 / 04	0.001%/mW/mvar	11D6	4	BCEC	2
Interharmonic Group 20 - Bin 6	03 / 04	0.001%/mW/mvar	11DA	4	BCEE	2
Interharmonic Group 20 - Bin 7	03 / 04	0.001%/mW/mvar	11DE	4	BCF0	2
Interharmonic Group 20 - Bin 8	03 / 04	0.001%/mW/mvar	11E2	4	BCF2	2
Interharmonic Group 20 - Bin 9	03 / 04	0.001%/mW/mvar	11E6	4	BCF4	2
Interharmonic Group 20 - Bin 10	03 / 04	0.001%/mW/mvar	11EA	4	BCF6	2
Interharmonic Group 20 - Bin 11	03 / 04	0.001%/mW/mvar	11EE	4	BCF8	2
21st Harmonic Component	03 / 04	0.001%/mW/mvar	11F2	4	BCFA	2
Interharmonic Group 21 - Bin 1	03 / 04	0.001%/mW/mvar	11F6	4	BCFC	2
Interharmonic Group 21 - Bin 2	03 / 04	0.001%/mW/mvar	11FA	4	BCFE	2
Interharmonic Group 21 - Bin 3	03 / 04	0.001%/mW/mvar	11FE	4	BD00	2
Interharmonic Group 21 - Bin 4	03 / 04	0.001%/mW/mvar	1202	4	BD02	2
Interharmonic Group 21 - Bin 5	03 / 04	0.001%/mW/mvar	1206	4	BD04	2
Interharmonic Group 21 - Bin 6	03 / 04	0.001%/mW/mvar	120A	4	BD06	2
Interharmonic Group 21 - Bin 7	03 / 04	0.001%/mW/mvar	120E	4	BD08	2
Interharmonic Group 21 - Bin 8	03 / 04	0.001%/mW/mvar	1212	4	BD0A	2
Interharmonic Group 21 - Bin 9	03 / 04	0.001%/mW/mvar	1216	4	BD0C	2
Interharmonic Group 21 - Bin 10	03 / 04	0.001%/mW/mvar	121A	4	BD0E	2
Interharmonic Group 21 - Bin 11	03 / 04	0.001%/mW/mvar	121E	4	BD10	2
22nd Harmonic Component	03 / 04	0.001%/mW/mvar	1222	4	BD12	2
Interharmonic Group 22 - Bin 1	03 / 04	0.001%/mW/mvar	1226	4	BD14	2
Interharmonic Group 22 - Bin 2	03 / 04	0.001%/mW/mvar	122A	4	BD16	2
Interharmonic Group 22 - Bin 3	03 / 04	0.001%/mW/mvar	122E	4	BD18	2
Interharmonic Group 22 - Bin 4	03 / 04	0.001%/mW/mvar	1232	4	BD1A	2
Interharmonic Group 22 - Bin 5	03 / 04	0.001%/mW/mvar	1236	4	BD1C	2
Interharmonic Group 22 - Bin 6	03 / 04	0.001%/mW/mvar	123A	4	BD1E	2
Interharmonic Group 22 - Bin 7	03 / 04	0.001%/mW/mvar	123E	4	BD20	2
Interharmonic Group 22 - Bin 8	03 / 04	0.001%/mW/mvar	1242	4	BD22	2
Interharmonic Group 22 - Bin 9	03 / 04	0.001%/mW/mvar	1246	4	BD24	2
Interharmonic Group 21 - Bin 10	03 / 04	0.001%/mW/mvar	124A	4	BD26	2
Interharmonic Group 21 - Bin 11	03 / 04	0.001%/mW/mvar	124E	4	BD28	2
23rd Harmonic Component	03 / 04	0.001%/mW/mvar	1252	4	BD2A	2
Interharmonic Group 23 - Bin 1	03 / 04	0.001%/mW/mvar	1256	4	BD2C	2
Interharmonic Group 23 - Bin 2	03 / 04	0.001%/mW/mvar	125A	4	BD2E	2
Interharmonic Group 23 - Bin 3	03 / 04	0.001%/mW/mvar	125E	4	BD30	2
Interharmonic Group 23 - Bin 4	03 / 04	0.001%/mW/mvar	1262	4	BD32	2
Interharmonic Group 23 - Bin 5	03 / 04	0.001%/mW/mvar	1266	4	BD34	2
Interharmonic Group 23 - Bin 6	03 / 04	0.001%/mW/mvar	126A	4	BD36	2
Interharmonic Group 23 - Bin 7	03 / 04	0.001%/mW/mvar	126E	4	BD38	2

Parameter	F. code (Hex)	M.U.	INTEGER		IEEE	
			Register (Hex)	Words	Register (Hex)	Words
POWER HARMONICS & INTERHARMONICS - fnom=60 Hz						
Interharmonic Group 23 - Bin 8	03 / 04	0.001%/mW/mvar	1272	4	BD3A	2
Interharmonic Group 23 - Bin 9	03 / 04	0.001%/mW/mvar	1276	4	BD3C	2
Interharmonic Group 23 - Bin 10	03 / 04	0.001%/mW/mvar	127A	4	BD3E	2
Interharmonic Group 23 - Bin 11	03 / 04	0.001%/mW/mvar	127E	4	BD40	2
24th Harmonic Component	03 / 04	0.001%/mW/mvar	1282	4	BD42	2
Interharmonic Group 24 - Bin 1	03 / 04	0.001%/mW/mvar	1286	4	BD44	2
Interharmonic Group 24 - Bin 2	03 / 04	0.001%/mW/mvar	128A	4	BD46	2
Interharmonic Group 24 - Bin 3	03 / 04	0.001%/mW/mvar	128E	4	BD48	2
Interharmonic Group 24 - Bin 4	03 / 04	0.001%/mW/mvar	1292	4	BD4A	2
Interharmonic Group 24 - Bin 5	03 / 04	0.001%/mW/mvar	1296	4	BD4C	2
Interharmonic Group 24 - Bin 6	03 / 04	0.001%/mW/mvar	129A	4	BD4E	2
Interharmonic Group 24 - Bin 7	03 / 04	0.001%/mW/mvar	129E	4	BD50	2
Interharmonic Group 24 - Bin 8	03 / 04	0.001%/mW/mvar	12A2	4	BD52	2
Interharmonic Group 24 - Bin 9	03 / 04	0.001%/mW/mvar	12A6	4	BD54	2
Interharmonic Group 24 - Bin 10	03 / 04	0.001%/mW/mvar	12AA	4	BD56	2
Interharmonic Group 24 - Bin 11	03 / 04	0.001%/mW/mvar	12AE	4	BD58	2
25th Harmonic Component	03 / 04	0.001%/mW/mvar	12B2	4	BD5A	2
Interharmonic Group 25 - Bin 1	03 / 04	0.001%/mW/mvar	12B6	4	BD5C	2
Interharmonic Group 25 - Bin 2	03 / 04	0.001%/mW/mvar	12BA	4	BD5E	2
Interharmonic Group 25 - Bin 3	03 / 04	0.001%/mW/mvar	12BE	4	BD60	2
Interharmonic Group 25 - Bin 4	03 / 04	0.001%/mW/mvar	12C2	4	BD62	2
Interharmonic Group 25 - Bin 5	03 / 04	0.001%/mW/mvar	12C6	4	BD64	2
Interharmonic Group 25 - Bin 6	03 / 04	0.001%/mW/mvar	12CA	4	BD66	2
Interharmonic Group 25 - Bin 7	03 / 04	0.001%/mW/mvar	12CE	4	BD68	2
Interharmonic Group 25 - Bin 8	03 / 04	0.001%/mW/mvar	12D2	4	BD6A	2
Interharmonic Group 25 - Bin 9	03 / 04	0.001%/mW/mvar	12D6	4	BD6C	2
Interharmonic Group 25 - Bin 10	03 / 04	0.001%/mW/mvar	12DA	4	BD6E	2
Interharmonic Group 25 - Bin 11	03 / 04	0.001%/mW/mvar	12DE	4	BD70	2
26th Harmonic Component	03 / 04	0.001%/mW/mvar	12E2	4	BD72	2
Interharmonic Group 26 - Bin 1	03 / 04	0.001%/mW/mvar	12E6	4	BD74	2
Interharmonic Group 26 - Bin 2	03 / 04	0.001%/mW/mvar	12EA	4	BD76	2
Interharmonic Group 26 - Bin 3	03 / 04	0.001%/mW/mvar	12EE	4	BD78	2
Interharmonic Group 26 - Bin 4	03 / 04	0.001%/mW/mvar	12F2	4	BD7A	2
Interharmonic Group 26 - Bin 5	03 / 04	0.001%/mW/mvar	12F6	4	BD7C	2
Interharmonic Group 26 - Bin 6	03 / 04	0.001%/mW/mvar	12FA	4	BD7E	2
Interharmonic Group 26 - Bin 7	03 / 04	0.001%/mW/mvar	12FE	4	BD80	2
Interharmonic Group 26 - Bin 8	03 / 04	0.001%/mW/mvar	1302	4	BD82	2
Interharmonic Group 26 - Bin 9	03 / 04	0.001%/mW/mvar	1306	4	BD84	2
Interharmonic Group 26 - Bin 10	03 / 04	0.001%/mW/mvar	130A	4	BD86	2
Interharmonic Group 26 - Bin 11	03 / 04	0.001%/mW/mvar	130E	4	BD88	2
27th Harmonic Component	03 / 04	0.001%/mW/mvar	1312	4	BD8A	2
Interharmonic Group 27 - Bin 1	03 / 04	0.001%/mW/mvar	1316	4	BD8C	2
Interharmonic Group 27 - Bin 2	03 / 04	0.001%/mW/mvar	131A	4	BD8E	2
Interharmonic Group 27 - Bin 3	03 / 04	0.001%/mW/mvar	131E	4	BD90	2
Interharmonic Group 27 - Bin 4	03 / 04	0.001%/mW/mvar	1322	4	BD92	2
Interharmonic Group 27 - Bin 5	03 / 04	0.001%/mW/mvar	1326	4	BD94	2
Interharmonic Group 27 - Bin 6	03 / 04	0.001%/mW/mvar	132A	4	BD96	2
Interharmonic Group 27 - Bin 7	03 / 04	0.001%/mW/mvar	132E	4	BD98	2
Interharmonic Group 27 - Bin 8	03 / 04	0.001%/mW/mvar	1332	4	BD9A	2
Interharmonic Group 27 - Bin 9	03 / 04	0.001%/mW/mvar	1336	4	BD9C	2

Parameter	F. code (Hex)	M.U.	INTEGER		IEEE	
			Register (Hex)	Words	Register (Hex)	Words
POWER HARMONICS & INTERHARMONICS - fnom=60 Hz						
Interharmonic Group 27 - Bin 10	03 / 04	0.001%/mW/mvar	133A	4	BD9E	2
Interharmonic Group 27 - Bin 11	03 / 04	0.001%/mW/mvar	133E	4	BDA0	2
28th Harmonic Component	03 / 04	0.001%/mW/mvar	1342	4	BDA2	2
Interharmonic Group 28 - Bin 1	03 / 04	0.001%/mW/mvar	1346	4	BDA4	2
Interharmonic Group 28 - Bin 2	03 / 04	0.001%/mW/mvar	134A	4	BDA6	2
Interharmonic Group 28 - Bin 3	03 / 04	0.001%/mW/mvar	134E	4	BDA8	2
Interharmonic Group 28 - Bin 4	03 / 04	0.001%/mW/mvar	1352	4	BDAA	2
Interharmonic Group 28 - Bin 5	03 / 04	0.001%/mW/mvar	1356	4	BDAC	2
Interharmonic Group 28 - Bin 6	03 / 04	0.001%/mW/mvar	135A	4	BDAE	2
Interharmonic Group 28 - Bin 7	03 / 04	0.001%/mW/mvar	135E	4	BDB0	2
Interharmonic Group 28 - Bin 8	03 / 04	0.001%/mW/mvar	1362	4	BDB2	2
Interharmonic Group 28 - Bin 9	03 / 04	0.001%/mW/mvar	1366	4	BDB4	2
Interharmonic Group 28 - Bin 10	03 / 04	0.001%/mW/mvar	136A	4	BDB6	2
Interharmonic Group 28 - Bin 11	03 / 04	0.001%/mW/mvar	136E	4	BDB8	2
29th Harmonic Component	03 / 04	0.001%/mW/mvar	1372	4	BDBA	2
Interharmonic Group 29 - Bin 1	03 / 04	0.001%/mW/mvar	1376	4	BDBC	2
Interharmonic Group 29 - Bin 2	03 / 04	0.001%/mW/mvar	137A	4	BDBE	2
Interharmonic Group 29 - Bin 3	03 / 04	0.001%/mW/mvar	137E	4	BDC0	2
Interharmonic Group 29 - Bin 4	03 / 04	0.001%/mW/mvar	1382	4	BDC2	2
Interharmonic Group 29 - Bin 5	03 / 04	0.001%/mW/mvar	1386	4	BDC4	2
Interharmonic Group 29 - Bin 6	03 / 04	0.001%/mW/mvar	138A	4	BDC6	2
Interharmonic Group 29 - Bin 7	03 / 04	0.001%/mW/mvar	138E	4	BDC8	2
Interharmonic Group 29 - Bin 8	03 / 04	0.001%/mW/mvar	1392	4	BDCA	2
Interharmonic Group 29 - Bin 9	03 / 04	0.001%/mW/mvar	1396	4	BDCC	2
Interharmonic Group 29 - Bin 10	03 / 04	0.001%/mW/mvar	139A	4	BDCE	2
Interharmonic Group 29 - Bin 11	03 / 04	0.001%/mW/mvar	139E	4	BDD0	2
30th Harmonic Component	03 / 04	0.001%/mW/mvar	13A2	4	BDD2	2
Interharmonic Group 30 - Bin 1	03 / 04	0.001%/mW/mvar	13A6	4	BDD4	2
Interharmonic Group 30 - Bin 2	03 / 04	0.001%/mW/mvar	13AA	4	BDD6	2
Interharmonic Group 30 - Bin 3	03 / 04	0.001%/mW/mvar	13AE	4	BDD8	2
Interharmonic Group 30 - Bin 4	03 / 04	0.001%/mW/mvar	13B2	4	BDDA	2
Interharmonic Group 30 - Bin 5	03 / 04	0.001%/mW/mvar	13B6	4	BDDC	2
Interharmonic Group 30 - Bin 6	03 / 04	0.001%/mW/mvar	13BA	4	BDDE	2
Interharmonic Group 30 - Bin 7	03 / 04	0.001%/mW/mvar	13BE	4	BDE0	2
Interharmonic Group 30 - Bin 8	03 / 04	0.001%/mW/mvar	13C2	4	BDE2	2
Interharmonic Group 30 - Bin 9	03 / 04	0.001%/mW/mvar	13C6	4	BDE4	2
Interharmonic Group 30 - Bin 10	03 / 04	0.001%/mW/mvar	13CA	4	BDE6	2
Interharmonic Group 30 - Bin 11	03 / 04	0.001%/mW/mvar	13CE	4	BDE8	2
31st Harmonic Component	03 / 04	0.001%/mW/mvar	13D2	4	BDEA	2
Interharmonic Group 31 - Bin 1	03 / 04	0.001%/mW/mvar	13D6	4	BDEC	2
Interharmonic Group 31 - Bin 2	03 / 04	0.001%/mW/mvar	13DA	4	BDEE	2
Interharmonic Group 31 - Bin 3	03 / 04	0.001%/mW/mvar	13DE	4	BDF0	2
Interharmonic Group 31 - Bin 4	03 / 04	0.001%/mW/mvar	13E2	4	BDF2	2
Interharmonic Group 31 - Bin 5	03 / 04	0.001%/mW/mvar	13E6	4	BDF4	2
Interharmonic Group 31 - Bin 6	03 / 04	0.001%/mW/mvar	13EA	4	BDF6	2
Interharmonic Group 31 - Bin 7	03 / 04	0.001%/mW/mvar	13EE	4	BDF8	2
Interharmonic Group 31 - Bin 8	03 / 04	0.001%/mW/mvar	13F2	4	BDFA	2
Interharmonic Group 31 - Bin 9	03 / 04	0.001%/mW/mvar	13F6	4	BDFC	2
Interharmonic Group 31 - Bin 10	03 / 04	0.001%/mW/mvar	13FA	4	BDFE	2
Interharmonic Group 31 - Bin 11	03 / 04	0.001%/mW/mvar	13FE	4	BE00	2

Parameter	F. code (Hex)	M.U.	INTEGER		IEEE	
			Register (Hex)	Words	Register (Hex)	Words
POWER HARMONICS & INTERHARMONICS - fnom=60 Hz						
32nd Harmonic Component	03 / 04	0.001%/mW/mvar	1402	4	BE02	2
Interharmonic Group 32 - Bin 1	03 / 04	0.001%/mW/mvar	1406	4	BE04	2
Interharmonic Group 32 - Bin 2	03 / 04	0.001%/mW/mvar	140A	4	BE06	2
Interharmonic Group 32 - Bin 3	03 / 04	0.001%/mW/mvar	140E	4	BE08	2
Interharmonic Group 32 - Bin 4	03 / 04	0.001%/mW/mvar	1412	4	BE0A	2
Interharmonic Group 32 - Bin 5	03 / 04	0.001%/mW/mvar	1416	4	BE0C	2
Interharmonic Group 32 - Bin 6	03 / 04	0.001%/mW/mvar	141A	4	BE0E	2
Interharmonic Group 32 - Bin 7	03 / 04	0.001%/mW/mvar	141E	4	BE10	2
Interharmonic Group 32 - Bin 8	03 / 04	0.001%/mW/mvar	1422	4	BE12	2
Interharmonic Group 32 - Bin 9	03 / 04	0.001%/mW/mvar	1426	4	BE14	2
Interharmonic Group 32 - Bin 10	03 / 04	0.001%/mW/mvar	142A	4	BE16	2
Interharmonic Group 32 - Bin 11	03 / 04	0.001%/mW/mvar	142E	4	BE18	2
33rd Harmonic Component	03 / 04	0.001%/mW/mvar	1432	4	BE1A	2
Interharmonic Group 33 - Bin 1	03 / 04	0.001%/mW/mvar	1436	4	BE1C	2
Interharmonic Group 33 - Bin 2	03 / 04	0.001%/mW/mvar	143A	4	BE1E	2
Interharmonic Group 33 - Bin 3	03 / 04	0.001%/mW/mvar	143E	4	BE20	2
Interharmonic Group 33 - Bin 4	03 / 04	0.001%/mW/mvar	1442	4	BE22	2
Interharmonic Group 33 - Bin 5	03 / 04	0.001%/mW/mvar	1446	4	BE24	2
Interharmonic Group 33 - Bin 6	03 / 04	0.001%/mW/mvar	144A	4	BE26	2
Interharmonic Group 33 - Bin 7	03 / 04	0.001%/mW/mvar	144E	4	BE28	2
Interharmonic Group 33 - Bin 8	03 / 04	0.001%/mW/mvar	1452	4	BE2A	2
Interharmonic Group 33 - Bin 9	03 / 04	0.001%/mW/mvar	1456	4	BE2C	2
Interharmonic Group 33 - Bin 10	03 / 04	0.001%/mW/mvar	145A	4	BE2E	2
Interharmonic Group 33 - Bin 11	03 / 04	0.001%/mW/mvar	145E	4	BE30	2
34th Harmonic Component	03 / 04	0.001%/mW/mvar	1462	4	BE32	2
Interharmonic Group 34 - Bin 1	03 / 04	0.001%/mW/mvar	1466	4	BE34	2
Interharmonic Group 34 - Bin 2	03 / 04	0.001%/mW/mvar	146A	4	BE36	2
Interharmonic Group 34 - Bin 3	03 / 04	0.001%/mW/mvar	146E	4	BE38	2
Interharmonic Group 34 - Bin 4	03 / 04	0.001%/mW/mvar	1472	4	BE3A	2
Interharmonic Group 34 - Bin 5	03 / 04	0.001%/mW/mvar	1476	4	BE3C	2
Interharmonic Group 34 - Bin 6	03 / 04	0.001%/mW/mvar	147A	4	BE3E	2
Interharmonic Group 34 - Bin 7	03 / 04	0.001%/mW/mvar	147E	4	BE40	2
Interharmonic Group 34 - Bin 8	03 / 04	0.001%/mW/mvar	1482	4	BE42	2
Interharmonic Group 34 - Bin 9	03 / 04	0.001%/mW/mvar	1486	4	BE44	2
Interharmonic Group 34 - Bin 10	03 / 04	0.001%/mW/mvar	148A	4	BE46	2
Interharmonic Group 34 - Bin 11	03 / 04	0.001%/mW/mvar	148E	4	BE48	2
35th Harmonic Component	03 / 04	0.001%/mW/mvar	1492	4	BE4A	2
Interharmonic Group 35 - Bin 1	03 / 04	0.001%/mW/mvar	1496	4	BE4C	2
Interharmonic Group 35 - Bin 2	03 / 04	0.001%/mW/mvar	149A	4	BE4E	2
Interharmonic Group 35 - Bin 3	03 / 04	0.001%/mW/mvar	149E	4	BE50	2
Interharmonic Group 35 - Bin 4	03 / 04	0.001%/mW/mvar	14A2	4	BE52	2
Interharmonic Group 35 - Bin 5	03 / 04	0.001%/mW/mvar	14A6	4	BE54	2
Interharmonic Group 35 - Bin 6	03 / 04	0.001%/mW/mvar	14AA	4	BE56	2
Interharmonic Group 35 - Bin 7	03 / 04	0.001%/mW/mvar	14AE	4	BE58	2
Interharmonic Group 35 - Bin 8	03 / 04	0.001%/mW/mvar	14B2	4	BE5A	2
Interharmonic Group 35 - Bin 9	03 / 04	0.001%/mW/mvar	14B6	4	BE5C	2
Interharmonic Group 35 - Bin 10	03 / 04	0.001%/mW/mvar	14BA	4	BE5E	2
Interharmonic Group 35 - Bin 11	03 / 04	0.001%/mW/mvar	14BE	4	BE60	2
36th Harmonic Component	03 / 04	0.001%/mW/mvar	14C2	4	BE62	2
Interharmonic Group 36 - Bin 1	03 / 04	0.001%/mW/mvar	14C6	4	BE64	2

Parameter	F. code (Hex)	M.U.	INTEGER		IEEE	
			Register (Hex)	Words	Register (Hex)	Words
POWER HARMONICS & INTERHARMONICS - fnom=60 Hz						
Interharmonic Group 36 - Bin 2	03 / 04	0.001%/mW/mvar	14CA	4	BE66	2
Interharmonic Group 36 - Bin 3	03 / 04	0.001%/mW/mvar	14CE	4	BE68	2
Interharmonic Group 36 - Bin 4	03 / 04	0.001%/mW/mvar	14D2	4	BE6A	2
Interharmonic Group 36 - Bin 5	03 / 04	0.001%/mW/mvar	14D6	4	BE6C	2
Interharmonic Group 36 - Bin 6	03 / 04	0.001%/mW/mvar	14DA	4	BE6E	2
Interharmonic Group 36 - Bin 7	03 / 04	0.001%/mW/mvar	14DE	4	BE70	2
Interharmonic Group 36 - Bin 8	03 / 04	0.001%/mW/mvar	14E2	4	BE72	2
Interharmonic Group 36 - Bin 9	03 / 04	0.001%/mW/mvar	14E6	4	BE74	2
Interharmonic Group 36 - Bin 10	03 / 04	0.001%/mW/mvar	14EA	4	BE76	2
Interharmonic Group 36 - Bin 11	03 / 04	0.001%/mW/mvar	14EE	4	BE78	2
37th Harmonic Component	03 / 04	0.001%/mW/mvar	14F2	4	BE7A	2
Interharmonic Group 37 - Bin 1	03 / 04	0.001%/mW/mvar	14F6	4	BE7C	2
Interharmonic Group 37 - Bin 2	03 / 04	0.001%/mW/mvar	14FA	4	BE7E	2
Interharmonic Group 37 - Bin 3	03 / 04	0.001%/mW/mvar	14FE	4	BE80	2
Interharmonic Group 37 - Bin 4	03 / 04	0.001%/mW/mvar	1502	4	BE82	2
Interharmonic Group 37 - Bin 5	03 / 04	0.001%/mW/mvar	1506	4	BE84	2
Interharmonic Group 37 - Bin 6	03 / 04	0.001%/mW/mvar	150A	4	BE86	2
Interharmonic Group 37 - Bin 7	03 / 04	0.001%/mW/mvar	150E	4	BE88	2
Interharmonic Group 37 - Bin 8	03 / 04	0.001%/mW/mvar	1512	4	BE8A	2
Interharmonic Group 37 - Bin 9	03 / 04	0.001%/mW/mvar	1516	4	BE8C	2
Interharmonic Group 37 - Bin 10	03 / 04	0.001%/mW/mvar	151A	4	BE8E	2
Interharmonic Group 37 - Bin 11	03 / 04	0.001%/mW/mvar	151E	4	BE90	2
38th Harmonic Component	03 / 04	0.001%/mW/mvar	1522	4	BE92	2
Interharmonic Group 38 - Bin 1	03 / 04	0.001%/mW/mvar	1526	4	BE94	2
Interharmonic Group 38 - Bin 2	03 / 04	0.001%/mW/mvar	152A	4	BE96	2
Interharmonic Group 38 - Bin 3	03 / 04	0.001%/mW/mvar	152E	4	BE98	2
Interharmonic Group 38 - Bin 4	03 / 04	0.001%/mW/mvar	1532	4	BE9A	2
Interharmonic Group 38 - Bin 5	03 / 04	0.001%/mW/mvar	1536	4	BE9C	2
Interharmonic Group 38 - Bin 6	03 / 04	0.001%/mW/mvar	153A	4	BE9E	2
Interharmonic Group 38 - Bin 7	03 / 04	0.001%/mW/mvar	153E	4	BEA0	2
Interharmonic Group 38 - Bin 8	03 / 04	0.001%/mW/mvar	1542	4	BEA2	2
Interharmonic Group 38 - Bin 9	03 / 04	0.001%/mW/mvar	1546	4	BEA4	2
Interharmonic Group 38 - Bin 10	03 / 04	0.001%/mW/mvar	154A	4	BEA6	2
Interharmonic Group 38 - Bin 11	03 / 04	0.001%/mW/mvar	154E	4	BEA8	2
39th Harmonic Component	03 / 04	0.001%/mW/mvar	1552	4	BEAA	2
Interharmonic Group 39 - Bin 1	03 / 04	0.001%/mW/mvar	1556	4	BEAC	2
Interharmonic Group 39 - Bin 2	03 / 04	0.001%/mW/mvar	155A	4	BEAE	2
Interharmonic Group 39 - Bin 3	03 / 04	0.001%/mW/mvar	155E	4	BEBO	2
Interharmonic Group 39 - Bin 4	03 / 04	0.001%/mW/mvar	1562	4	BEB2	2
Interharmonic Group 39 - Bin 5	03 / 04	0.001%/mW/mvar	1566	4	BEB4	2
Interharmonic Group 39 - Bin 6	03 / 04	0.001%/mW/mvar	156A	4	BEB6	2
Interharmonic Group 39 - Bin 7	03 / 04	0.001%/mW/mvar	156E	4	BEB8	2
Interharmonic Group 39 - Bin 8	03 / 04	0.001%/mW/mvar	1572	4	BEBA	2
Interharmonic Group 39 - Bin 9	03 / 04	0.001%/mW/mvar	1576	4	BEBC	2
Interharmonic Group 39 - Bin 10	03 / 04	0.001%/mW/mvar	157A	4	BEBE	2
Interharmonic Group 39 - Bin 11	03 / 04	0.001%/mW/mvar	157E	4	BEC0	2
40th Harmonic Component	03 / 04	0.001%/mW/mvar	1582	4	BEC2	2
Interharmonic Group 40 - Bin 1	03 / 04	0.001%/mW/mvar	1586	4	BEC4	2
Interharmonic Group 40 - Bin 2	03 / 04	0.001%/mW/mvar	158A	4	BEC6	2
Interharmonic Group 40 - Bin 3	03 / 04	0.001%/mW/mvar	158E	4	BEC8	2

Parameter	F. code (Hex)	M.U.	INTEGER		IEEE	
			Register (Hex)	Words	Register (Hex)	Words
POWER HARMONICS & INTERHARMONICS - fnom=60 Hz						
Interharmonic Group 40 - Bin 4	03 / 04	0.001%/mW/mvar	1592	4	BECA	2
Interharmonic Group 40 - Bin 5	03 / 04	0.001%/mW/mvar	1596	4	BECC	2
Interharmonic Group 40 - Bin 6	03 / 04	0.001%/mW/mvar	159A	4	BECE	2
Interharmonic Group 40 - Bin 7	03 / 04	0.001%/mW/mvar	159E	4	BED0	2
Interharmonic Group 40 - Bin 8	03 / 04	0.001%/mW/mvar	15A2	4	BED2	2
Interharmonic Group 40 - Bin 9	03 / 04	0.001%/mW/mvar	15A6	4	BED4	2
Interharmonic Group 40 - Bin 10	03 / 04	0.001%/mW/mvar	15AA	4	BED6	2
Interharmonic Group 40 - Bin 11	03 / 04	0.001%/mW/mvar	15AE	4	BED8	2
41st Harmonic Component	03 / 04	0.001%/mW/mvar	15B2	4	BEDA	2
Interharmonic Group 41 - Bin 1	03 / 04	0.001%/mW/mvar	15B6	4	BEDC	2
Interharmonic Group 41 - Bin 2	03 / 04	0.001%/mW/mvar	15BA	4	BEDE	2
Interharmonic Group 41 - Bin 3	03 / 04	0.001%/mW/mvar	15BE	4	BEE0	2
Interharmonic Group 41 - Bin 4	03 / 04	0.001%/mW/mvar	15C2	4	BEE2	2
Interharmonic Group 41 - Bin 5	03 / 04	0.001%/mW/mvar	15C6	4	BEE4	2
Interharmonic Group 41 - Bin 6	03 / 04	0.001%/mW/mvar	15CA	4	BEE6	2
Interharmonic Group 41 - Bin 7	03 / 04	0.001%/mW/mvar	15CE	4	BEE8	2
Interharmonic Group 41 - Bin 8	03 / 04	0.001%/mW/mvar	15D2	4	BEEA	2
Interharmonic Group 41 - Bin 9	03 / 04	0.001%/mW/mvar	15D6	4	BEEC	2
Interharmonic Group 41 - Bin 10	03 / 04	0.001%/mW/mvar	15DA	4	BEEE	2
Interharmonic Group 41 - Bin 11	03 / 04	0.001%/mW/mvar	15DE	4	BEF0	2
42nd Harmonic Component	03 / 04	0.001%/mW/mvar	15E2	4	BEF2	2
Interharmonic Group 42 - Bin 1	03 / 04	0.001%/mW/mvar	15E6	4	BEF4	2
Interharmonic Group 42 - Bin 2	03 / 04	0.001%/mW/mvar	15EA	4	BEF6	2
Interharmonic Group 42 - Bin 3	03 / 04	0.001%/mW/mvar	15EE	4	BEF8	2
Interharmonic Group 42 - Bin 4	03 / 04	0.001%/mW/mvar	15F2	4	BEFA	2
Interharmonic Group 42 - Bin 5	03 / 04	0.001%/mW/mvar	15F6	4	BEFC	2
Interharmonic Group 42 - Bin 6	03 / 04	0.001%/mW/mvar	15FA	4	BEFE	2
Interharmonic Group 42 - Bin 7	03 / 04	0.001%/mW/mvar	15FE	4	BF00	2
Interharmonic Group 42 - Bin 8	03 / 04	0.001%/mW/mvar	1602	4	BF02	2
Interharmonic Group 42 - Bin 9	03 / 04	0.001%/mW/mvar	1606	4	BF04	2
Interharmonic Group 42 - Bin 10	03 / 04	0.001%/mW/mvar	160A	4	BF06	2
Interharmonic Group 42 - Bin 11	03 / 04	0.001%/mW/mvar	160E	4	BF08	2
43rd Harmonic Component	03 / 04	0.001%/mW/mvar	1612	4	BF0A	2
Interharmonic Group 43 - Bin 1	03 / 04	0.001%/mW/mvar	1616	4	BF0C	2
Interharmonic Group 43 - Bin 2	03 / 04	0.001%/mW/mvar	161A	4	BF0E	2
Interharmonic Group 43 - Bin 3	03 / 04	0.001%/mW/mvar	161E	4	BF10	2
Interharmonic Group 43 - Bin 4	03 / 04	0.001%/mW/mvar	1622	4	BF12	2
Interharmonic Group 43 - Bin 5	03 / 04	0.001%/mW/mvar	1626	4	BF14	2
Interharmonic Group 43 - Bin 6	03 / 04	0.001%/mW/mvar	162A	4	BF16	2
Interharmonic Group 43 - Bin 7	03 / 04	0.001%/mW/mvar	162E	4	BF18	2
Interharmonic Group 43 - Bin 8	03 / 04	0.001%/mW/mvar	1632	4	BF1A	2
Interharmonic Group 43 - Bin 9	03 / 04	0.001%/mW/mvar	1636	4	BF1C	2
Interharmonic Group 43 - Bin 10	03 / 04	0.001%/mW/mvar	163A	4	BF1E	2
Interharmonic Group 43 - Bin 11	03 / 04	0.001%/mW/mvar	163E	4	BF20	2
44th Harmonic Component	03 / 04	0.001%/mW/mvar	1642	4	BF22	2
Interharmonic Group 44 - Bin 1	03 / 04	0.001%/mW/mvar	1646	4	BF24	2
Interharmonic Group 44 - Bin 2	03 / 04	0.001%/mW/mvar	164A	4	BF26	2
Interharmonic Group 44 - Bin 3	03 / 04	0.001%/mW/mvar	164E	4	BF28	2
Interharmonic Group 44 - Bin 4	03 / 04	0.001%/mW/mvar	1652	4	BF2A	2
Interharmonic Group 44 - Bin 5	03 / 04	0.001%/mW/mvar	1656	4	BF2C	2

Parameter	F. code (Hex)	M.U.	INTEGER		IEEE	
			Register (Hex)	Words	Register (Hex)	Words
POWER HARMONICS & INTERHARMONICS - fnom=60 Hz						
Interharmonic Group 44 - Bin 6	03 / 04	0.001%/mW/mvar	165A	4	BF2E	2
Interharmonic Group 44 - Bin 7	03 / 04	0.001%/mW/mvar	165E	4	BF30	2
Interharmonic Group 44 - Bin 8	03 / 04	0.001%/mW/mvar	1662	4	BF32	2
Interharmonic Group 44 - Bin 9	03 / 04	0.001%/mW/mvar	1666	4	BF34	2
Interharmonic Group 44 - Bin 10	03 / 04	0.001%/mW/mvar	166A	4	BF36	2
Interharmonic Group 44 - Bin 11	03 / 04	0.001%/mW/mvar	166E	4	BF38	2
45th Harmonic Component	03 / 04	0.001%/mW/mvar	1672	4	BF3A	2
Interharmonic Group 45 - Bin 1	03 / 04	0.001%/mW/mvar	1676	4	BF3C	2
Interharmonic Group 45 - Bin 2	03 / 04	0.001%/mW/mvar	167A	4	BF3E	2
Interharmonic Group 45 - Bin 3	03 / 04	0.001%/mW/mvar	167E	4	BF40	2
Interharmonic Group 45 - Bin 4	03 / 04	0.001%/mW/mvar	1682	4	BF42	2
Interharmonic Group 45 - Bin 5	03 / 04	0.001%/mW/mvar	1686	4	BF44	2
Interharmonic Group 45 - Bin 6	03 / 04	0.001%/mW/mvar	168A	4	BF46	2
Interharmonic Group 45 - Bin 7	03 / 04	0.001%/mW/mvar	168E	4	BF48	2
Interharmonic Group 45 - Bin 8	03 / 04	0.001%/mW/mvar	1692	4	BF4A	2
Interharmonic Group 45 - Bin 9	03 / 04	0.001%/mW/mvar	1696	4	BF4C	2
Interharmonic Group 45 - Bin 10	03 / 04	0.001%/mW/mvar	169A	4	BF4E	2
Interharmonic Group 45 - Bin 11	03 / 04	0.001%/mW/mvar	169E	4	BF50	2
46th Harmonic Component	03 / 04	0.001%/mW/mvar	16A2	4	BF52	2
Interharmonic Group 46 - Bin 1	03 / 04	0.001%/mW/mvar	16A6	4	BF54	2
Interharmonic Group 46 - Bin 2	03 / 04	0.001%/mW/mvar	16AA	4	BF56	2
Interharmonic Group 46 - Bin 3	03 / 04	0.001%/mW/mvar	16AE	4	BF58	2
Interharmonic Group 46 - Bin 4	03 / 04	0.001%/mW/mvar	16B2	4	BF5A	2
Interharmonic Group 46 - Bin 5	03 / 04	0.001%/mW/mvar	16B6	4	BF5C	2
Interharmonic Group 46 - Bin 6	03 / 04	0.001%/mW/mvar	16BA	4	BF5E	2
Interharmonic Group 46 - Bin 7	03 / 04	0.001%/mW/mvar	16BE	4	BF60	2
Interharmonic Group 46 - Bin 8	03 / 04	0.001%/mW/mvar	16C2	4	BF62	2
Interharmonic Group 46 - Bin 9	03 / 04	0.001%/mW/mvar	16C6	4	BF64	2
Interharmonic Group 46 - Bin 10	03 / 04	0.001%/mW/mvar	16CA	4	BF66	2
Interharmonic Group 46 - Bin 11	03 / 04	0.001%/mW/mvar	16CE	4	BF68	2
47th Harmonic Component	03 / 04	0.001%/mW/mvar	16D2	4	BF6A	2
Interharmonic Group 47 - Bin 1	03 / 04	0.001%/mW/mvar	16D6	4	BF6C	2
Interharmonic Group 47 - Bin 2	03 / 04	0.001%/mW/mvar	16DA	4	BF6E	2
Interharmonic Group 47 - Bin 3	03 / 04	0.001%/mW/mvar	16DE	4	BF70	2
Interharmonic Group 47 - Bin 4	03 / 04	0.001%/mW/mvar	16E2	4	BF72	2
Interharmonic Group 47 - Bin 5	03 / 04	0.001%/mW/mvar	16E6	4	BF74	2
Interharmonic Group 47 - Bin 6	03 / 04	0.001%/mW/mvar	16EA	4	BF76	2
Interharmonic Group 47 - Bin 7	03 / 04	0.001%/mW/mvar	16EE	4	BF78	2
Interharmonic Group 47 - Bin 8	03 / 04	0.001%/mW/mvar	16F2	4	BF7A	2
Interharmonic Group 47 - Bin 9	03 / 04	0.001%/mW/mvar	16F6	4	BF7C	2
Interharmonic Group 47 - Bin 10	03 / 04	0.001%/mW/mvar	16FA	4	BF7E	2
Interharmonic Group 47 - Bin 11	03 / 04	0.001%/mW/mvar	16FE	4	BF80	2
48th Harmonic Component	03 / 04	0.001%/mW/mvar	1702	4	BF82	2
Interharmonic Group 48 - Bin 1	03 / 04	0.001%/mW/mvar	1706	4	BF84	2
Interharmonic Group 48 - Bin 2	03 / 04	0.001%/mW/mvar	170A	4	BF86	2
Interharmonic Group 48 - Bin 3	03 / 04	0.001%/mW/mvar	170E	4	BF88	2
Interharmonic Group 48 - Bin 4	03 / 04	0.001%/mW/mvar	1712	4	BF8A	2
Interharmonic Group 48 - Bin 5	03 / 04	0.001%/mW/mvar	1716	4	BF8C	2
Interharmonic Group 48 - Bin 6	03 / 04	0.001%/mW/mvar	171A	4	BF8E	2
Interharmonic Group 48 - Bin 7	03 / 04	0.001%/mW/mvar	171E	4	BF90	2

Parameter	F. code (Hex)	M.U.	INTEGER		IEEE	
			Register (Hex)	Words	Register (Hex)	Words
POWER HARMONICS & INTERHARMONICS - fnom=60 Hz						
Interharmonic Group 48 - Bin 8	03 / 04	0.001%/mW/mvar	1722	4	BF92	2
Interharmonic Group 48 - Bin 9	03 / 04	0.001%/mW/mvar	1726	4	BF94	2
Interharmonic Group 48 - Bin 10	03 / 04	0.001%/mW/mvar	172A	4	BF96	2
Interharmonic Group 48 - Bin 11	03 / 04	0.001%/mW/mvar	172E	4	BF98	2
49th Harmonic Component	03 / 04	0.001%/mW/mvar	1732	4	BF9A	2
Interharmonic Group 49 - Bin 1	03 / 04	0.001%/mW/mvar	1736	4	BF9C	2
Interharmonic Group 49 - Bin 2	03 / 04	0.001%/mW/mvar	173A	4	BF9E	2
Interharmonic Group 49 - Bin 3	03 / 04	0.001%/mW/mvar	173E	4	BFA0	2
Interharmonic Group 49 - Bin 4	03 / 04	0.001%/mW/mvar	1742	4	BFA2	2
Interharmonic Group 49 - Bin 5	03 / 04	0.001%/mW/mvar	1746	4	BFA4	2
Interharmonic Group 49 - Bin 6	03 / 04	0.001%/mW/mvar	174A	4	BFA6	2
Interharmonic Group 49 - Bin 7	03 / 04	0.001%/mW/mvar	174E	4	BFA8	2
Interharmonic Group 49 - Bin 8	03 / 04	0.001%/mW/mvar	1752	4	BFAA	2
Interharmonic Group 49 - Bin 9	03 / 04	0.001%/mW/mvar	1756	4	BFAC	2
Interharmonic Group 49 - Bin 10	03 / 04	0.001%/mW/mvar	175A	4	BFAE	2
Interharmonic Group 49 - Bin 11	03 / 04	0.001%/mW/mvar	175E	4	BFB0	2
50th Harmonic Component	03 / 04	0.001%/mW/mvar	1762	4	BFB2	2
Interharmonic Group 50 - Bin 1	03 / 04	0.001%/mW/mvar	1766	4	BFB4	2
Interharmonic Group 50 - Bin 2	03 / 04	0.001%/mW/mvar	176A	4	BFB6	2
Interharmonic Group 50 - Bin 3	03 / 04	0.001%/mW/mvar	176E	4	BFB8	2
Interharmonic Group 50 - Bin 4	03 / 04	0.001%/mW/mvar	1772	4	BFBA	2
Interharmonic Group 50 - Bin 5	03 / 04	0.001%/mW/mvar	1776	4	BFBC	2
Interharmonic Group 50 - Bin 6	03 / 04	0.001%/mW/mvar	177A	4	BFBE	2
Interharmonic Group 50 - Bin 7	03 / 04	0.001%/mW/mvar	177E	4	BFC0	2
Interharmonic Group 50 - Bin 8	03 / 04	0.001%/mW/mvar	1782	4	BFC2	2
Interharmonic Group 50 - Bin 9	03 / 04	0.001%/mW/mvar	1786	4	BFC4	2
Interharmonic Group 50 - Bin 10	03 / 04	0.001%/mW/mvar	178A	4	BFC6	2
Interharmonic Group 50 - Bin 11	03 / 04	0.001%/mW/mvar	178E	4	BFC8	2
51st Harmonic Component	03 / 04	0.001%/mW/mvar	1792	4	BFCA	2
Interharmonic Group 51 - Bin 1	03 / 04	0.001%/mW/mvar	1796	4	BFCC	2
Interharmonic Group 51 - Bin 2	03 / 04	0.001%/mW/mvar	179A	4	BFCE	2
Interharmonic Group 51 - Bin 3	03 / 04	0.001%/mW/mvar	179E	4	BFD0	2
Interharmonic Group 51 - Bin 4	03 / 04	0.001%/mW/mvar	17A2	4	BFD2	2
Interharmonic Group 51 - Bin 5	03 / 04	0.001%/mW/mvar	17A6	4	BFD4	2
Interharmonic Group 51 - Bin 6	03 / 04	0.001%/mW/mvar	17AA	4	BFD6	2
Interharmonic Group 51 - Bin 7	03 / 04	0.001%/mW/mvar	17AE	4	BFD8	2
Interharmonic Group 51 - Bin 8	03 / 04	0.001%/mW/mvar	17B2	4	BFDA	2
Interharmonic Group 51 - Bin 9	03 / 04	0.001%/mW/mvar	17B6	4	BFDC	2
Interharmonic Group 51 - Bin 10	03 / 04	0.001%/mW/mvar	17BA	4	BFDE	2
Interharmonic Group 51 - Bin 11	03 / 04	0.001%/mW/mvar	17BE	4	BFE0	2
52nd Harmonic Component	03 / 04	0.001%/mW/mvar	17C2	4	BFE2	2
Interharmonic Group 52 - Bin 1	03 / 04	0.001%/mW/mvar	17C6	4	BFE4	2
Interharmonic Group 52 - Bin 2	03 / 04	0.001%/mW/mvar	17CA	4	BFE6	2
Interharmonic Group 52 - Bin 3	03 / 04	0.001%/mW/mvar	17CE	4	BFE8	2
Interharmonic Group 52 - Bin 4	03 / 04	0.001%/mW/mvar	17D2	4	BFEA	2
Interharmonic Group 52 - Bin 5	03 / 04	0.001%/mW/mvar	17D6	4	BFEC	2
Interharmonic Group 52 - Bin 6	03 / 04	0.001%/mW/mvar	17DA	4	BFEE	2
Interharmonic Group 52 - Bin 7	03 / 04	0.001%/mW/mvar	17DE	4	BFF0	2
Interharmonic Group 52 - Bin 8	03 / 04	0.001%/mW/mvar	17E2	4	BFF2	2
Interharmonic Group 52 - Bin 9	03 / 04	0.001%/mW/mvar	17E6	4	BFF4	2

Parameter	F. code (Hex)	M.U.	INTEGER		IEEE	
			Register (Hex)	Words	Register (Hex)	Words
POWER HARMONICS & INTERHARMONICS - fnom=60 Hz						
Interharmonic Group 52 - Bin 10	03 / 04	0.001%/mW/mvar	17EA	4	BFF6	2
Interharmonic Group 52 - Bin 11	03 / 04	0.001%/mW/mvar	17EE	4	BFF8	2
53rd Harmonic Component	03 / 04	0.001%/mW/mvar	17F2	4	BFFA	2
Interharmonic Group 53 - Bin 1	03 / 04	0.001%/mW/mvar	17F6	4	BFFC	2
Interharmonic Group 53 - Bin 2	03 / 04	0.001%/mW/mvar	17FA	4	BFFE	2
Interharmonic Group 53 - Bin 3	03 / 04	0.001%/mW/mvar	17FE	4	C000	2
Interharmonic Group 53 - Bin 4	03 / 04	0.001%/mW/mvar	1802	4	C002	2
Interharmonic Group 53 - Bin 5	03 / 04	0.001%/mW/mvar	1806	4	C004	2
Interharmonic Group 53 - Bin 6	03 / 04	0.001%/mW/mvar	180A	4	C006	2
Interharmonic Group 53 - Bin 7	03 / 04	0.001%/mW/mvar	180E	4	C008	2
Interharmonic Group 53 - Bin 8	03 / 04	0.001%/mW/mvar	1812	4	C00A	2
Interharmonic Group 53 - Bin 9	03 / 04	0.001%/mW/mvar	1816	4	C00C	2
Interharmonic Group 53 - Bin 10	03 / 04	0.001%/mW/mvar	181A	4	C00E	2
Interharmonic Group 53 - Bin 11	03 / 04	0.001%/mW/mvar	181E	4	C010	2
54th Harmonic Component	03 / 04	0.001%/mW/mvar	1822	4	C012	2
Interharmonic Group 54 - Bin 1	03 / 04	0.001%/mW/mvar	1826	4	C014	2
Interharmonic Group 54 - Bin 2	03 / 04	0.001%/mW/mvar	182A	4	C016	2
Interharmonic Group 54 - Bin 3	03 / 04	0.001%/mW/mvar	182E	4	C018	2
Interharmonic Group 54 - Bin 4	03 / 04	0.001%/mW/mvar	1832	4	C01A	2
Interharmonic Group 54 - Bin 5	03 / 04	0.001%/mW/mvar	1836	4	C01C	2
Interharmonic Group 54 - Bin 6	03 / 04	0.001%/mW/mvar	183A	4	C01E	2
Interharmonic Group 54 - Bin 7	03 / 04	0.001%/mW/mvar	183E	4	C020	2
Interharmonic Group 54 - Bin 8	03 / 04	0.001%/mW/mvar	1842	4	C022	2
Interharmonic Group 54 - Bin 9	03 / 04	0.001%/mW/mvar	1846	4	C024	2
Interharmonic Group 54 - Bin 10	03 / 04	0.001%/mW/mvar	184A	4	C026	2
Interharmonic Group 54 - Bin 11	03 / 04	0.001%/mW/mvar	184E	4	C028	2
55th Harmonic Component	03 / 04	0.001%/mW/mvar	1852	4	C02A	2
Interharmonic Group 55 - Bin 1	03 / 04	0.001%/mW/mvar	1856	4	C02C	2
Interharmonic Group 55 - Bin 2	03 / 04	0.001%/mW/mvar	185A	4	C02E	2
Interharmonic Group 55 - Bin 3	03 / 04	0.001%/mW/mvar	185E	4	C030	2
Interharmonic Group 55 - Bin 4	03 / 04	0.001%/mW/mvar	1862	4	C032	2
Interharmonic Group 55 - Bin 5	03 / 04	0.001%/mW/mvar	1866	4	C034	2
Interharmonic Group 55 - Bin 6	03 / 04	0.001%/mW/mvar	186A	4	C036	2
Interharmonic Group 55 - Bin 7	03 / 04	0.001%/mW/mvar	186E	4	C038	2
Interharmonic Group 55 - Bin 8	03 / 04	0.001%/mW/mvar	1872	4	C03A	2
Interharmonic Group 55 - Bin 9	03 / 04	0.001%/mW/mvar	1876	4	C03C	2
Interharmonic Group 55 - Bin 10	03 / 04	0.001%/mW/mvar	187A	4	C03E	2
Interharmonic Group 55 - Bin 11	03 / 04	0.001%/mW/mvar	187E	4	C040	2
56th Harmonic Component	03 / 04	0.001%/mW/mvar	1882	4	C042	2
Interharmonic Group 56 - Bin 1	03 / 04	0.001%/mW/mvar	1886	4	C044	2
Interharmonic Group 56 - Bin 2	03 / 04	0.001%/mW/mvar	188A	4	C046	2
Interharmonic Group 56 - Bin 3	03 / 04	0.001%/mW/mvar	188E	4	C048	2
Interharmonic Group 56 - Bin 4	03 / 04	0.001%/mW/mvar	1892	4	C04A	2
Interharmonic Group 56 - Bin 5	03 / 04	0.001%/mW/mvar	1896	4	C04C	2
Interharmonic Group 56 - Bin 6	03 / 04	0.001%/mW/mvar	189A	4	C04E	2
Interharmonic Group 56 - Bin 7	03 / 04	0.001%/mW/mvar	189E	4	C050	2
Interharmonic Group 56 - Bin 8	03 / 04	0.001%/mW/mvar	18A2	4	C052	2
Interharmonic Group 56 - Bin 9	03 / 04	0.001%/mW/mvar	18A6	4	C054	2
Interharmonic Group 56 - Bin 10	03 / 04	0.001%/mW/mvar	18AA	4	C056	2
Interharmonic Group 56 - Bin 11	03 / 04	0.001%/mW/mvar	18AE	4	C058	2

Parameter	F. code (Hex)	M.U.	INTEGER		IEEE	
			Register (Hex)	Words	Register (Hex)	Words
POWER HARMONICS & INTERHARMONICS - fnom=60 Hz						
57th Harmonic Component	03 / 04	0.001%/mW/mvar	18B2	4	C05A	2
Interharmonic Group 57 - Bin 1	03 / 04	0.001%/mW/mvar	18B6	4	C05C	2
Interharmonic Group 57 - Bin 2	03 / 04	0.001%/mW/mvar	18BA	4	C05E	2
Interharmonic Group 57 - Bin 3	03 / 04	0.001%/mW/mvar	18BE	4	C060	2
Interharmonic Group 57 - Bin 4	03 / 04	0.001%/mW/mvar	18C2	4	C062	2
Interharmonic Group 57 - Bin 5	03 / 04	0.001%/mW/mvar	18C6	4	C064	2
Interharmonic Group 57 - Bin 6	03 / 04	0.001%/mW/mvar	18CA	4	C066	2
Interharmonic Group 57 - Bin 7	03 / 04	0.001%/mW/mvar	18CE	4	C068	2
Interharmonic Group 57 - Bin 8	03 / 04	0.001%/mW/mvar	18D2	4	C06A	2
Interharmonic Group 57 - Bin 9	03 / 04	0.001%/mW/mvar	18D6	4	C06C	2
Interharmonic Group 57 - Bin 10	03 / 04	0.001%/mW/mvar	18DA	4	C06E	2
Interharmonic Group 57 - Bin 11	03 / 04	0.001%/mW/mvar	18DE	4	C070	2
58th Harmonic Component	03 / 04	0.001%/mW/mvar	18E2	4	C072	2
Interharmonic Group 58 - Bin 1	03 / 04	0.001%/mW/mvar	18E6	4	C074	2
Interharmonic Group 58 - Bin 2	03 / 04	0.001%/mW/mvar	18EA	4	C076	2
Interharmonic Group 58 - Bin 3	03 / 04	0.001%/mW/mvar	18EE	4	C078	2
Interharmonic Group 58 - Bin 4	03 / 04	0.001%/mW/mvar	18F2	4	C07A	2
Interharmonic Group 58 - Bin 5	03 / 04	0.001%/mW/mvar	18F6	4	C07C	2
Interharmonic Group 58 - Bin 6	03 / 04	0.001%/mW/mvar	18FA	4	C07E	2
Interharmonic Group 58 - Bin 7	03 / 04	0.001%/mW/mvar	18FE	4	C080	2
Interharmonic Group 58 - Bin 8	03 / 04	0.001%/mW/mvar	1902	4	C082	2
Interharmonic Group 58 - Bin 9	03 / 04	0.001%/mW/mvar	1906	4	C084	2
Interharmonic Group 58 - Bin 10	03 / 04	0.001%/mW/mvar	190A	4	C086	2
Interharmonic Group 58 - Bin 11	03 / 04	0.001%/mW/mvar	190E	4	C088	2
59th Harmonic Component	03 / 04	0.001%/mW/mvar	1912	4	C08A	2
Interharmonic Group 59 - Bin 1	03 / 04	0.001%/mW/mvar	1916	4	C08C	2
Interharmonic Group 59 - Bin 2	03 / 04	0.001%/mW/mvar	191A	4	C08E	2
Interharmonic Group 59 - Bin 3	03 / 04	0.001%/mW/mvar	191E	4	C090	2
Interharmonic Group 59 - Bin 4	03 / 04	0.001%/mW/mvar	1922	4	C092	2
Interharmonic Group 59 - Bin 5	03 / 04	0.001%/mW/mvar	1926	4	C094	2
Interharmonic Group 59 - Bin 6	03 / 04	0.001%/mW/mvar	192A	4	C096	2
Interharmonic Group 59 - Bin 7	03 / 04	0.001%/mW/mvar	192E	4	C098	2
Interharmonic Group 59 - Bin 8	03 / 04	0.001%/mW/mvar	1932	4	C09A	2
Interharmonic Group 59 - Bin 9	03 / 04	0.001%/mW/mvar	1936	4	C09C	2
Interharmonic Group 59 - Bin 10	03 / 04	0.001%/mW/mvar	193A	4	C09E	2
Interharmonic Group 59 - Bin 11	03 / 04	0.001%/mW/mvar	193E	4	C0A0	2
60th Harmonic Component	03 / 04	0.001%/mW/mvar	1942	4	C0A2	2
Interharmonic Group 60 - Bin 1	03 / 04	0.001%/mW/mvar	1946	4	C0A4	2
Interharmonic Group 60 - Bin 2	03 / 04	0.001%/mW/mvar	194A	4	C0A6	2
Interharmonic Group 60 - Bin 3	03 / 04	0.001%/mW/mvar	194E	4	C0A8	2
Interharmonic Group 60 - Bin 4	03 / 04	0.001%/mW/mvar	1952	4	C0AA	2
Interharmonic Group 60 - Bin 5	03 / 04	0.001%/mW/mvar	1956	4	C0AC	2
Interharmonic Group 60 - Bin 6	03 / 04	0.001%/mW/mvar	195A	4	C0AE	2
Interharmonic Group 60 - Bin 7	03 / 04	0.001%/mW/mvar	195E	4	C0B0	2
Interharmonic Group 60 - Bin 8	03 / 04	0.001%/mW/mvar	1962	4	C0B2	2
Interharmonic Group 60 - Bin 9	03 / 04	0.001%/mW/mvar	1966	4	C0B4	2
Interharmonic Group 60 - Bin 10	03 / 04	0.001%/mW/mvar	196A	4	C0B6	2
Interharmonic Group 60 - Bin 11	03 / 04	0.001%/mW/mvar	196E	4	C0B8	2
61st Harmonic Component	03 / 04	0.001%/mW/mvar	1972	4	C0BA	2
Interharmonic Group 61 - Bin 1	03 / 04	0.001%/mW/mvar	1976	4	C0BC	2

Parameter	F. code (Hex)	M.U.	INTEGER		IEEE	
			Register (Hex)	Words	Register (Hex)	Words
POWER HARMONICS & INTERHARMONICS - fnom=60 Hz						
Interharmonic Group 61 - Bin 2	03 / 04	0.001%/mW/mvar	197A	4	C0BE	2
Interharmonic Group 61 - Bin 3	03 / 04	0.001%/mW/mvar	197E	4	C0C0	2
Interharmonic Group 61 - Bin 4	03 / 04	0.001%/mW/mvar	1982	4	C0C2	2
Interharmonic Group 61 - Bin 5	03 / 04	0.001%/mW/mvar	1986	4	C0C4	2
Interharmonic Group 61 - Bin 6	03 / 04	0.001%/mW/mvar	198A	4	C0C6	2
Interharmonic Group 61 - Bin 7	03 / 04	0.001%/mW/mvar	198E	4	C0C8	2
Interharmonic Group 61 - Bin 8	03 / 04	0.001%/mW/mvar	1992	4	C0CA	2
Interharmonic Group 61 - Bin 9	03 / 04	0.001%/mW/mvar	1996	4	C0CC	2
Interharmonic Group 61 - Bin 10	03 / 04	0.001%/mW/mvar	199A	4	C0CE	2
Interharmonic Group 61 - Bin 11	03 / 04	0.001%/mW/mvar	199E	4	C0D0	2
62nd Harmonic Component	03 / 04	0.001%/mW/mvar	19A2	4	C0D2	2
Interharmonic Group 62 - Bin 1	03 / 04	0.001%/mW/mvar	19A6	4	C0D4	2
Interharmonic Group 62 - Bin 2	03 / 04	0.001%/mW/mvar	19AA	4	C0D6	2
Interharmonic Group 62 - Bin 3	03 / 04	0.001%/mW/mvar	19AE	4	C0D8	2
Interharmonic Group 62 - Bin 4	03 / 04	0.001%/mW/mvar	19B2	4	C0DA	2
Interharmonic Group 62 - Bin 5	03 / 04	0.001%/mW/mvar	19B6	4	C0DC	2
Interharmonic Group 62 - Bin 6	03 / 04	0.001%/mW/mvar	19BA	4	C0DE	2
Interharmonic Group 62 - Bin 7	03 / 04	0.001%/mW/mvar	19BE	4	C0E0	2
Interharmonic Group 62 - Bin 8	03 / 04	0.001%/mW/mvar	19C2	4	C0E2	2
Interharmonic Group 62 - Bin 9	03 / 04	0.001%/mW/mvar	19C6	4	C0E4	2
Interharmonic Group 62 - Bin 10	03 / 04	0.001%/mW/mvar	19CA	4	C0E6	2
Interharmonic Group 62 - Bin 11	03 / 04	0.001%/mW/mvar	19CE	4	C0E8	2
63rd Harmonic Component	03 / 04	0.001%/mW/mvar	19D2	4	C0EA	2
Interharmonic Group 63 - Bin 1	03 / 04	0.001%/mW/mvar	19D6	4	C0EC	2
Interharmonic Group 63 - Bin 2	03 / 04	0.001%/mW/mvar	19DA	4	C0EE	2
Interharmonic Group 63 - Bin 3	03 / 04	0.001%/mW/mvar	19DE	4	C0F0	2
Interharmonic Group 63 - Bin 4	03 / 04	0.001%/mW/mvar	19E2	4	C0F2	2
Interharmonic Group 63 - Bin 5	03 / 04	0.001%/mW/mvar	19E6	4	C0F4	2
Interharmonic Group 63 - Bin 6	03 / 04	0.001%/mW/mvar	19EA	4	C0F6	2
Interharmonic Group 63 - Bin 7	03 / 04	0.001%/mW/mvar	19EE	4	C0F8	2
Interharmonic Group 63 - Bin 8	03 / 04	0.001%/mW/mvar	19F2	4	C0FA	2
Interharmonic Group 63 - Bin 9	03 / 04	0.001%/mW/mvar	19F6	4	C0FC	2
Interharmonic Group 63 - Bin 10	03 / 04	0.001%/mW/mvar	19FA	4	C0FE	2
Interharmonic Group 63 - Bin 11	03 / 04	0.001%/mW/mvar	19FE	4	C100	2

Parameter	F. code (Hex)	M.U.	INTEGER	
			Register (Hex)	Words

VOLTAGE AGGREGATED VALUES ACCORDING TO IEC/EN 61000-4-30:2015 ED.3

Phase 1 to Neutral Voltage for 10/12c aggregation	03 / 04	mV	A000	2
Phase 2 to Neutral Voltage for 10/12c aggregation	03 / 04	mV	A002	2
Phase 3 to Neutral Voltage for 10/12c aggregation	03 / 04	mV	A004	2
Timestamp for 10/12c aggregation. Data format: compact BCD	03 / 04	10 ms	A006	4
<u>Example</u> Read value: \$0015123123595999 = 2015/12/31 23:59:59.99 (yyyy/mm/dd hh:mm:ss.cc)				
Flag for 10/12c aggregation. \$00=not flagged, \$01=flagged	03 / 04	-	A00A	2
Phase 1 to Neutral Voltage for 150/180c aggregation	03 / 04	mV	A00C	2
Phase 2 to Neutral Voltage for 150/180c aggregation	03 / 04	mV	A00E	2
Phase 3 to Neutral Voltage for 150/180c aggregation	03 / 04	mV	A010	2

Parameter	F. code (Hex)	M.U.	INTEGER	
			Register (Hex)	Words
VOLTAGE AGGREGATED VALUES ACCORDING TO IEC/EN 61000-4-30:2015 ED.3				
Timestamp for 150/180c aggregation. Data format: compact BCD	03/04	10ms	A012	4
Flag for 150/180c aggregation. \$00=not flagged, \$01=flagged	03/04	-	A016	2
Phase 1 to Neutral Voltage for 10min aggregation	03/04	mV	A018	2
Phase 2 to Neutral Voltage for 10min aggregation	03/04	mV	A01A	2
Phase 3 to Neutral Voltage for 10min aggregation	03/04	mV	A01C	2
Timestamp for 10min aggregation. Data format: compact BCD	03/04	10 ms	A01E	4
Flag for 10min aggregation. \$00=not flagged, \$01=flagged	03/04	-	A022	2
10/12c block number in 10min aggregation	03/04	-	A024	2
150/180c block number in 10min aggregation	03/04	-	A026	2
Phase 1 to Neutral Voltage for 2h aggregation	03/04	mV	A028	2
Phase 2 to Neutral Voltage for 2h aggregation	03/04	mV	A02A	2
Phase 3 to Neutral Voltage for 2h aggregation	03/04	mV	A02C	2
Timestamp for 2h aggregation. Data format: compact BCD	03/04	10 ms	A02E	4
Flag for 2h aggregation. \$00=not flagged, \$01=flagged	03/04	-	A032	2
Frequency	03/04	mHz	A034	2
Timestamp for 10s frequency. Data format: compact BCD	03/04	10 ms	A036	4
Flag for 10s frequency. \$00=not flagged, \$01=flagged	03/04	-	A03A	2
Number of 10/12c records	03/04	-	A03C	2
RTC Lock. \$00=not locked, \$01=NTP, \$02=GPS	03/04	-	A03E	2
Phase 1N (L12) Instantaneous Flicker for 10/12c aggregation	03/04	0.001	A040	2
Phase 2N (L23) Instantaneous Flicker for 10/12c aggregation	03/04	0.001	A042	2
Phase 3N (L31) Instantaneous Flicker for 10/12c aggregation	03/04	0.001	A044	2
Timestamp for 10/12c aggregation. Data format: compact BCD	03/04	10 ms	A046	4
Flag for 10/12c aggregation. \$00=not flagged, \$01=flagged	03/04	-	A04A	2
Phase 1N (L12) Short Term Flicker for 10min aggregation	03/04	0.001	A04C	2
Phase 2N (L23) Short Term Flicker for 10min aggregation	03/04	0.001	A04E	2
Phase 3N (L31) Short Term Flicker for 10min aggregation	03/04	0.001	A050	2
Timestamp for 10min aggregation. Data format: compact BCD	03/04	10 ms	A052	4
Flag for 10min aggregation. \$00=not flagged, \$01=flagged	03/04	-	A056	2
10/12c block number in 10min aggregation	03/04	-	A058	2
Phase 1N (L12) Long Term Flicker for 2h aggregation	03/04	0.001	A05A	2
Phase 2N (L23) Long Term Flicker for 2h aggregation	03/04	0.001	A05C	2
Phase 3N (L31) Long Term Flicker for 2h aggregation	03/04	0.001	A05E	2
Timestamp for 2h aggregation. Data format: compact BCD	03/04	10 ms	A060	4
Flag for 2h aggregation. \$00=not flagged, \$01=flagged	03/04	-	A064	2
Number of 10/12 cycles records	03/04	-	A066	2
RTC Lock. \$00=not locked, \$01=NTP, \$02=GPS	03/04	-	A068	2
Negative Sequence Unbalance Ratio for 10/12c aggregation	03/04	0.01%	A06A	2
Zero Sequence Unbalance Ratio for 10/12c aggregation	03/04	0.01%	A06C	2
Timestamp for 10/12c aggregation. Data format: compact BCD	03/04	10 ms	A06E	4
Flag for 10/12c aggregation. \$00=not flagged, \$01=flagged	03/04	-	A072	2
Negative Sequence Unbalance Ratio for 150/180c aggregation	03/04	0.01%	A074	2
Zero Sequence Unbalance Ratio for 150/180c aggregation	03/04	0.01%	A076	2
Timestamp for 150/180c aggregation. Data format: compact BCD	03/04	10 ms	A078	4
Flag for 150/180c aggregation. \$00=not flagged, \$01=flagged	03/04	-	A07C	2
Negative Sequence Unbalance Ratio for 10min aggregation	03/04	0.01%	A07E	2
Zero Sequence Unbalance Ratio for 10min aggregation	03/04	0.01%	A080	2
Timestamp for 10min aggregation. Data format: compact BCD	03/04	10 ms	A082	4
Flag for 10min aggregation. \$00=not flagged, \$01=flagged	03/04	-	A086	2
10/12c block number in 10min aggregation	03/04	-	A088	2

Parameter	F. code (Hex)	M.U.	INTEGER	
			Register (Hex)	Words
VOLTAGE AGGREGATED VALUES ACCORDING TO IEC/EN 61000-4-30:2015 ED.3				
150/180c block number in 10min aggregation	03/04	-	A08A	2
Negative Sequence Unbalance Ratio for 2h aggregation	03/04	0.01%	A08C	2
Zero Sequence Unbalance Ratio for 2h aggregation	03/04	0.01%	A08E	2
Timestamp for 2h aggregation. Data format: compact BCD	03/04	10 ms	A090	4
Flag for 2h aggregation. \$00=not flagged, \$01=flagged	03/04	-	A094	2
Number of 10/12 cycles records	03/04	-	A096	2
RTC Lock. \$00=not locked, \$01=NTP, \$02=GPS	03/04	-	A098	2
Phase 1 to Neutral Voltage Underdeviation for 10/12c aggregation	03/04	mV	A09A	2
Phase 2 to Neutral Voltage Underdeviation for 10/12c aggregation	03/04	mV	A09C	2
Phase 3 to Neutral Voltage Underdeviation for 10/12c aggregation	03/04	mV	A09E	2
Line 1 to 2 Voltage Underdeviation for 10/12c aggregation	03/04	mV	A0A0	2
Line 2 to 3 Voltage Underdeviation for 10/12c aggregation	03/04	mV	A0A2	2
Line 3 to 1 Voltage Underdeviation for 10/12c aggregation	03/04	mV	A0A4	2
Timestamp for 10/12c aggregation. Data format: compact BCD	03/04	10 ms	A0A6	4
Flag for 10/12c aggregation. \$00=not flagged, \$01=flagged	03/04	-	A0AA	2
Phase 1 to Neutral Voltage Underdeviation for 150/180c aggregation	03/04	mV	A0AC	2
Phase 2 to Neutral Voltage Underdeviation for 150/180c aggregation	03/04	mV	A0AE	2
Phase 3 to Neutral Voltage Underdeviation for 150/180c aggregation	03/04	mV	A0B0	2
Line 1 to 2 Voltage Underdeviation for 150/180c aggregation	03/04	mV	A0B2	2
Line 2 to 3 Voltage Underdeviation for 150/180c aggregation	03/04	mV	A0B4	2
Line 3 to 1 Voltage Underdeviation for 150/180c aggregation	03/04	mV	A0B6	2
Timestamp for 150/180c aggregation. Data format: compact BCD	03/04	10 ms	A0B8	4
Flag for 150/180c aggregation. \$00=not flagged, \$01=flagged	03/04	-	A0BC	2
Phase 1 to Neutral Voltage Underdeviation for 10min aggregation	03/04	mV	A0BE	2
Phase 2 to Neutral Voltage Underdeviation for 10min aggregation	03/04	mV	A0C0	2
Phase 3 to Neutral Voltage Underdeviation for 10min aggregation	03/04	mV	A0C2	2
Line 1 to 2 Voltage Underdeviation for 10min aggregation	03/04	mV	A0C4	2
Line 2 to 3 Voltage Underdeviation for 10min aggregation	03/04	mV	A0C6	2
Line 3 to 1 Voltage Underdeviation for 10min aggregation	03/04	mV	A0C8	2
Timestamp for 10min aggregation. Data format: compact BCD	03/04	10 ms	A0CA	4
Flag for 10min aggregation. \$00=not flagged, \$01=flagged	03/04	-	A0CE	2
10/12c block number in 10min aggregation	03/04	-	A0D0	2
150/180c block number in 10min aggregation	03/04	-	A0D2	2
Phase 1 to Neutral Voltage Underdeviation for 2h aggregation	03/04	mV	A0D4	2
Phase 2 to Neutral Voltage Underdeviation for 2h aggregation	03/04	mV	A0D6	2
Phase 3 to Neutral Voltage Underdeviation for 2h aggregation	03/04	mV	A0D8	2
Line 1 to 2 Voltage Underdeviation for 2h aggregation	03/04	mV	A0DA	2
Line 2 to 3 Voltage Underdeviation for 2h aggregation	03/04	mV	A0DC	2
Line 3 to 1 Voltage Underdeviation for 2h aggregation	03/04	mV	A0DE	2
Timestamp for 2h aggregation. Data format: compact BCD	03/04	10 ms	A0E0	4
Flag for 2h aggregation. \$00=not flagged, \$01=flagged	03/04	-	A0E4	2
Number of 10/12 cycles records	03/04	-	A0E6	2
RTC Lock. \$00=not locked, \$01=NTP, \$02=GPS	03/04	-	A0E8	2
Phase 1 to Neutral Voltage Overdeviation for 10/12c aggregation	03/04	mV	A0EA	2
Phase 2 to Neutral Voltage Overdeviation for 10/12c aggregation	03/04	mV	A0EC	2
Phase 3 to Neutral Voltage Overdeviation for 10/12c aggregation	03/04	mV	A0EE	2
Line 1 to 2 Voltage Overdeviation for 10/12c aggregation	03/04	mV	A0F0	2
Line 2 to 3 Voltage Overdeviation for 10/12c aggregation	03/04	mV	A0F2	2
Line 3 to 1 Voltage Overdeviation for 10/12c aggregation	03/04	mV	A0F4	2
Timestamp for 10/12c aggregation. Data format: compact BCD	03/04	10 ms	A0F6	4

Parameter	F. code (Hex)	M.U.	INTEGER	
			Register (Hex)	Words
VOLTAGE AGGREGATED VALUES ACCORDING TO IEC/EN 61000-4-30:2015 ED.3				
Flag for 10/12c aggregation. \$00=not flagged, \$01=flagged	03/04	-	A0FA	2
Phase 1 to Neutral Voltage Overdeviation for 150/180c aggregation	03/04	mV	A0FC	2
Phase 2 to Neutral Voltage Overdeviation for 150/180c aggregation	03/04	mV	A0FE	2
Phase 3 to Neutral Voltage Overdeviation for 150/180c aggregation	03/04	mV	A100	2
Line 1 to 2 Voltage Overdeviation for 150/180c aggregation	03/04	mV	A102	2
Line 2 to 3 Voltage Overdeviation for 150/180c aggregation	03/04	mV	A104	2
Line 3 to 1 Voltage Overdeviation for 150/180c aggregation	03/04	mV	A106	2
Timestamp for 150/180c aggregation. Data format: compact BCD	03/04	10 ms	A108	4
Flag for 150/180c aggregation. \$00=not flagged, \$01=flagged	03/04	-	A10C	2
Phase 1 to Neutral Voltage Overdeviation for 10min aggregation	03/04	mV	A10E	2
Phase 2 to Neutral Voltage Overdeviation for 10min aggregation	03/04	mV	A110	2
Phase 3 to Neutral Voltage Overdeviation for 10min aggregation	03/04	mV	A112	2
Line 1 to 2 Voltage Overdeviation for 10min aggregation	03/04	mV	A114	2
Line 2 to 3 Voltage Overdeviation for 10min aggregation	03/04	mV	A116	2
Line 3 to 1 Voltage Overdeviation for 10min aggregation	03/04	mV	A118	2
Timestamp for 10min aggregation. Data format: compact BCD	03/04	10 ms	A11A	4
Flag for 10min aggregation. \$00=not flagged, \$01=flagged	03/04	-	A11E	2
10/12c block number in 10min aggregation	03/04	-	A120	2
150/180c block number in 10min aggregation	03/04	-	A122	2
Phase 1 to Neutral Voltage Overdeviation for 2h aggregation	03/04	mV	A124	2
Phase 2 to Neutral Voltage Overdeviation for 2h aggregation	03/04	mV	A126	2
Phase 3 to Neutral Voltage Overdeviation for 2h aggregation	03/04	mV	A128	2
Line 1 to 2 Voltage Overdeviation for 2h aggregation	03/04	mV	A12A	2
Line 2 to 3 Voltage Overdeviation for 2h aggregation	03/04	mV	A12C	2
Line 3 to 1 Voltage Overdeviation for 2h aggregation	03/04	mV	A12E	2
Timestamp for 2h aggregation. Data format: compact BCD	03/04	10 ms	A130	4
Flag for 2h aggregation. \$00=not flagged, \$01=flagged	03/04	-	A134	2
Number of 10/12 cycles records	03/04	-	A136	2
RTC Lock. \$00=not locked, \$01=NTP, \$02=GPS	03/04	-	A138	2
Phase 1 to Neutral Mains Signalling 1 for 10/12c aggregation	03/04	mV	A13A	2
Timestamp for 10/12c. Data format: compact BCD	03/04	10 ms	A13C	4
Flag for Phase 1 MS value. \$00=not flagged, \$01=flagged	03/04	-	A140	2
Phase 2 to Neutral Mains Signalling 1 for 10/12c aggregation	03/04	mV	A142	2
Timestamp for 10/12c. Data format: compact BCD	03/04	10 ms	A144	4
Flag for Phase 1 MS value. \$00=not flagged, \$01=flagged	03/04	-	A148	2
Phase 3 to Neutral Mains Signalling 1 for 10/12c aggregation	03/04	mV	A14A	2
Timestamp for 10/12c. Data format: compact BCD	03/04	10 ms	A14C	4
Flag for Phase 1 MS value. \$00=not flagged, \$01=flagged	03/04	-	A150	2
Number of 10/12 cycles records	03/04	-	A152	2
RTC Lock. \$00=not locked, \$01=NTP, \$02=GPS	03/04	-	A154	2
Phase 1 to Neutral Mains Signalling 1 for 10/12c aggregation	03/04	mV	A156	2
Phase 1 to Neutral Mains Signalling 2 for 10/12c aggregation	03/04	mV	A158	2
Phase 1 to Neutral Mains Signalling 3 for 10/12c aggregation	03/04	mV	A15A	2
Phase 1 to Neutral Mains Signalling 4 for 10/12c aggregation	03/04	mV	A15C	2
Phase 1 to Neutral Mains Signalling 5 for 10/12c aggregation	03/04	mV	A15E	2
Phase 2 to Neutral Mains Signalling 1 for 10/12c aggregation	03/04	mV	A160	2
Phase 2 to Neutral Mains Signalling 2 for 10/12c aggregation	03/04	mV	A162	2
Phase 2 to Neutral Mains Signalling 3 for 10/12c aggregation	03/04	mV	A164	2
Phase 2 to Neutral Mains Signalling 4 for 10/12c aggregation	03/04	mV	A166	2
Phase 2 to Neutral Mains Signalling 5 for 10/12c aggregation	03/04	mV	A168	2

Parameter	F. code (Hex)	M.U.	INTEGER	
			Register (Hex)	Words
VOLTAGE AGGREGATED VALUES ACCORDING TO IEC/EN 61000-4-30:2015 ED.3				
Phase 3 to Neutral Mains Signalling 1 for 10/12c aggregation	03/04	mV	A16A	2
Phase 3 to Neutral Mains Signalling 2 for 10/12c aggregation	03/04	mV	A16C	2
Phase 3 to Neutral Mains Signalling 3 for 10/12c aggregation	03/04	mV	A16E	2
Phase 3 to Neutral Mains Signalling 4 for 10/12c aggregation	03/04	mV	A170	2
Phase 3 to Neutral Mains Signalling 5 for 10/12c aggregation	03/04	mV	A172	2
Timestamp for 10/12c aggregation. Data format: compact BCD	03/04	10 ms	A174	4
Flag for 10/12c aggregation. \$00=not flagged, \$01=flagged	03/04	-	A178	2
Phase 1 to Neutral Mains Signalling 1 for 150/180c aggregation	03/04	mV	A17A	2
Phase 1 to Neutral Mains Signalling 2 for 150/180c aggregation	03/04	mV	A17C	2
Phase 1 to Neutral Mains Signalling 3 for 150/180c aggregation	03/04	mV	A17E	2
Phase 1 to Neutral Mains Signalling 4 for 150/180c aggregation	03/04	mV	A180	2
Phase 1 to Neutral Mains Signalling 5 for 150/180c aggregation	03/04	mV	A182	2
Phase 2 to Neutral Mains Signalling 1 for 150/180c aggregation	03/04	mV	A184	2
Phase 2 to Neutral Mains Signalling 2 for 150/180c aggregation	03/04	mV	A186	2
Phase 2 to Neutral Mains Signalling 3 for 150/180c aggregation	03/04	mV	A188	2
Phase 2 to Neutral Mains Signalling 4 for 150/180c aggregation	03/04	mV	A18A	2
Phase 2 to Neutral Mains Signalling 5 for 150/180c aggregation	03/04	mV	A18C	2
Phase 3 to Neutral Mains Signalling 1 for 150/180c aggregation	03/04	mV	A18E	2
Phase 3 to Neutral Mains Signalling 2 for 150/180c aggregation	03/04	mV	A190	2
Phase 3 to Neutral Mains Signalling 3 for 150/180c aggregation	03/04	mV	A192	2
Phase 3 to Neutral Mains Signalling 4 for 150/180c aggregation	03/04	mV	A194	2
Phase 3 to Neutral Mains Signalling 5 for 150/180c aggregation	03/04	mV	A196	2
Timestamp for 150/180c aggregation. Data format: compact BCD	03/04	10 ms	A198	4
Flag for 150/180c aggregation. \$00=not flagged, \$01=flagged	03/04	-	A19C	2
Phase 1 to Neutral Mains Signalling 1 for 10min aggregation	03/04	mV	A19E	2
Phase 1 to Neutral Mains Signalling 2 for 10min aggregation	03 / 04	mV	A1A0	2
Phase 1 to Neutral Mains Signalling 3 for 10min aggregation	03 / 04	mV	A1A2	2
Phase 1 to Neutral Mains Signalling 4 for 10min aggregation	03/04	mV	A1A4	2
Phase 1 to Neutral Mains Signalling 5 for 10min aggregation	03/04	mV	A1A6	2
Phase 2 to Neutral Mains Signalling 1 for 10min aggregation	03/04	mV	A1A8	2
Phase 2 to Neutral Mains Signalling 2 for 10min aggregation	03/04	mV	A1AA	2
Phase 2 to Neutral Mains Signalling 3 for 10min aggregation	03/04	mV	A1AC	2
Phase 2 to Neutral Mains Signalling 4 for 10min aggregation	03/04	mV	A1AE	2
Phase 2 to Neutral Mains Signalling 5 for 10min aggregation	03/04	mV	A1B0	2
Phase 3 to Neutral Mains Signalling 1 for 10min aggregation	03/04	mV	A1B2	2
Phase 3 to Neutral Mains Signalling 2 for 10min aggregation	03/04	mV	A1B4	2
Phase 3 to Neutral Mains Signalling 3 for 10min aggregation	03/04	mV	A1B6	2
Phase 3 to Neutral Mains Signalling 4 for 10min aggregation	03/04	mV	A1B8	2
Phase 3 to Neutral Mains Signalling 5 for 10min aggregation	03/04	mV	A1BA	2
Timestamp for 10min aggregation. Data format: compact BCD	03/04	10 ms	A1BC	4
Flag for 10min aggregation. \$00=not flagged, \$01=flagged	03/04	-	A1C0	2
10/12c block number in 10min aggregation	03/04	-	A1C2	2
150/180c block number in 10min aggregation	03/04	-	A1C4	2
Phase 1 to Neutral Mains Signalling 1 for 2h aggregation	03/04	mV	A1C6	2
Phase 1 to Neutral Mains Signalling 2 for 2h aggregation	03/04	mV	A1C8	2
Phase 1 to Neutral Mains Signalling 3 for 2h aggregation	03/04	mV	A1CA	2
Phase 1 to Neutral Mains Signalling 4 for 2h aggregation	03/04	mV	A1CC	2
Phase 1 to Neutral Mains Signalling 5 for 2h aggregation	03/04	mV	A1CE	2
Phase 2 to Neutral Mains Signalling 1 for 2h aggregation	03/04	mV	A1D0	2
Phase 2 to Neutral Mains Signalling 2 for 2h aggregation	03/04	mV	A1D2	2

Parameter	F. code (Hex)	M.U.	INTEGER	
			Register (Hex)	Words
VOLTAGE AGGREGATED VALUES ACCORDING TO IEC/EN 61000-4-30:2015 ED.3				
Phase 2 to Neutral Mains Signalling 3 for 2h aggregation	03/04	mV	A1D4	2
Phase 2 to Neutral Mains Signalling 4 for 2h aggregation	03/04	mV	A1D6	2
Phase 2 to Neutral Mains Signalling 5 for 2h aggregation	03/04	mV	A1D8	2
Phase 3 to Neutral Mains Signalling 1 for 2h aggregation	03/04	mV	A1DA	2
Phase 3 to Neutral Mains Signalling 2 for 2h aggregation	03/04	mV	A1DC	2
Phase 3 to Neutral Mains Signalling 3 for 2h aggregation	03/04	mV	A1DE	2
Phase 3 to Neutral Mains Signalling 4 for 2h aggregation	03/04	mV	A1E0	2
Phase 3 to Neutral Mains Signalling 5 for 2h aggregation	03/04	mV	A1E2	2
Timestamp for 2h aggregation. Data format: compact BCD	03/04	10 ms	A1E4	4
Flag for 2h aggregation. \$00=not flagged, \$01=flagged	03/04	-	A1E8	2
Number of 10/12 cycles records	03/04	-	A1EA	2
Real time clock. Data format: compact BCD	03/04	s	A1EC	4
RTC Lock. \$00=not locked, \$01=NTP, \$02=GPS	03/04	-	A1F0	2

Parameter	F. code (Hex)	M.U.	INTEGER	
			Register (Hex)	Words
CURRENT AGGREGATED VALUES ACCORDING TO IEC/EN 61000-4-30:2015 ED.3				
Phase 1 Current for 10/12c aggregation	03 / 04	0.1 mA	AA00	2
Phase 2 Current for 10/12c aggregation	03 / 04	0.1 mA	AA02	2
Phase 3 Current for 10/12c aggregation	03 / 04	0.1 mA	AA04	2
Timestamp for 10/12c aggregation. Data format: compact BCD	03 / 04	10 ms	AA06	4
Example Read value: \$0015123123595999 = 2015/12/31 23:59:59.99 (yyyy/mm/dd hh:mm:ss.cc)				
Flag for 10/12c aggregation. \$00=not flagged, \$01=flagged	03 / 04	-	AA0A	2
Phase 1 Current for 150/180c aggregation	03 / 04	0.1 mA	AA0C	2
Phase 2 Current for 150/180c aggregation	03 / 04	0.1 mA	AA0E	2
Phase 3 Current for 150/180c aggregation	03 / 04	0.1 mA	AA10	2
Timestamp for 150/180c aggregation. Data format: compact BCD	03 / 04	10 ms	AA12	4
Flag for 150/180c aggregation. \$00=not flagged, \$01=flagged	03 / 04	-	AA16	2
Phase 1 Current for 10min aggregation	03 / 04	0.1 mA	AA18	2
Phase 2 Current for 10min aggregation	03 / 04	0.1 mA	AA1A	2
Phase 3 Current for 10min aggregation	03 / 04	0.1 mA	AA1C	2
Timestamp for 10min aggregation. Data format: compact BCD	03 / 04	10 ms	AA1E	4
Flag for 10min aggregation. \$00=not flagged, \$01=flagged	03 / 04	-	AA22	2
10/12c block number in 10min aggregation	03 / 04	-	AA24	2
150/180c block number in 10min aggregation	03 / 04	-	AA26	2
Phase 1 Current for 2h aggregation	03 / 04	0.1 mA	AA28	2
Phase 2 Current for 2h aggregation	03 / 04	0.1 mA	AA2A	2
Phase 3 Current for 2h aggregation	03 / 04	0.1 mA	AA2C	2
Timestamp for 2h aggregation. Data format: compact BCD	03 / 04	10 ms	AA2E	4
Flag for 2h aggregation. \$00=not flagged, \$01=flagged	03 / 04	-	AA32	2
Number of 10/12c records	03 / 04	-	AA34	2
RTC Lock. \$00=not locked, \$01=NTP, \$02=GPS	03 / 04	-	AA36	2
Current Negative Sequence Unbalance Ratio for 10/12c aggregation	03 / 04	0.01%	AA38	2
Current Zero Sequence Unbalance Ratio for 10/12c aggregation	03 / 04	0.01%	AA3A	2
Timestamp for 10/12c aggregation. Data format: compact BCD	03 / 04	10 ms	AA3C	4
Flag for 10/12c aggregation. \$00=not flagged, \$01=flagged	03 / 04	-	AA40	2

Parameter	F. code (Hex)	M.U.	INTEGER	
			Register (Hex)	Words
CURRENT AGGREGATED VALUES ACCORDING TO IEC/EN 61000-4-30:2015 ED.3				
Current Negative Sequence Unbalance Ratio for 150/180c aggregation	03 / 04	0.01%	AA42	2
Current Zero Sequence Unbalance Ratio for 150/180c aggregation	03 / 04	0.01%	AA44	2
Timestamp for 150/180c aggregation. Data format: compact BCD	03 / 04	10 ms	AA46	4
Flag for 150/180c aggregation. \$00=not flagged, \$01=flagged	03 / 04	-	AA4A	2
Current Negative Sequence Unbalance Ratio for 10min aggregation	03 / 04	0.01%	AA4C	2
Current Zero Sequence Unbalance Ratio for 10min aggregation	03 / 04	0.01%	AA4E	2
Timestamp for 10min aggregation. Data format: compact BCD	03 / 04	10 ms	AA50	4
Flag for 10min aggregation. \$00=not flagged, \$01=flagged	03 / 04	-	AA54	2
10/12c block number in 10min aggregation	03 / 04	-	AA56	2
150/180c block number in 10min aggregation	03 / 04	-	AA58	2
Current Negative Sequence Unbalance Ratio for 2h aggregation	03 / 04	0.01%	AA5A	2
Current Zero Sequence Unbalance Ratio for 2h aggregation	03 / 04	0.01%	AA5C	2
Timestamp for 2h aggregation. Data format: compact BCD	03 / 04	10 ms	AA5E	4
Flag for 2h aggregation. \$00=not flagged, \$01=flagged	03 / 04	-	AA62	2
Number of 10/12 cycles records	03 / 04	-	AA64	2
RTC Lock. \$00=not locked, \$01=NTP, \$02=GPS	03 / 04	-	AA66	2

Parameter	F. code (Hex)	M.U.	INTEGER	
			Register (Hex)	Words
HARMONICS ACCORDING TO IEC/EN 61000-4-30:2015 ED.3				
Set the harmonic phase/line for data reading Programmable data: \$01=Phase 1 / Line 12 Voltage \$02=Phase 2 / Line 23 Voltage \$03=Phase 3 / Line 31 Voltage \$04=Phase 1 Current \$05=Phase 2 Current \$06=Phase 3 Current	10	-	A200	2
Set the harmonic aggregation period for data reading Programmable data: \$00=10/12c \$01=150/180c \$02=10min \$03=2h	10	-	A202	2
DC Harmonic subgroup	03 / 04	mV/0.1 mA	A204	2
1st order Harmonic subgroup	03 / 04	mV/0.1 mA	A206	2
2nd order Harmonic subgroup	03 / 04	mV/0.1 mA	A208	2
3rd order Harmonic subgroup	03 / 04	mV/0.1 mA	A20A	2
4th order Harmonic subgroup	03 / 04	mV/0.1 mA	A20C	2
5th order Harmonic subgroup	03 / 04	mV/0.1 mA	A20E	2
6th order Harmonic subgroup	03 / 04	mV/0.1 mA	A210	2
7th order Harmonic subgroup	03 / 04	mV/0.1 mA	A212	2
8th order Harmonic subgroup	03 / 04	mV/0.1 mA	A214	2
9th order Harmonic subgroup	03 / 04	mV/0.1 mA	A216	2
10th order Harmonic subgroup	03 / 04	mV/0.1 mA	A218	2
11th order Harmonic subgroup	03 / 04	mV/0.1 mA	A21A	2
12th order Harmonic subgroup	03 / 04	mV/0.1 mA	A21C	2
13th order Harmonic subgroup	03 / 04	mV/0.1 mA	A21E	2
14th order Harmonic subgroup	03 / 04	mV/0.1 mA	A220	2
15th order Harmonic subgroup	03 / 04	mV/0.1 mA	A222	2
16th order Harmonic subgroup	03 / 04	mV/0.1 mA	A224	2
17th order Harmonic subgroup	03 / 04	mV/0.1 mA	A226	2
18th order Harmonic subgroup	03 / 04	mV/0.1 mA	A228	2
19th order Harmonic subgroup	03 / 04	mV/0.1 mA	A22A	2
20th order Harmonic subgroup	03 / 04	mV/0.1 mA	A22C	2
21st order Harmonic subgroup	03 / 04	mV/0.1 mA	A22E	2
22nd order Harmonic subgroup	03 / 04	mV/0.1 mA	A230	2
23rd order Harmonic subgroup	03 / 04	mV/0.1 mA	A232	2
24th order Harmonic subgroup	03 / 04	mV/0.1 mA	A234	2
25th order Harmonic subgroup	03 / 04	mV/0.1 mA	A236	2
26th order Harmonic subgroup	03 / 04	mV/0.1 mA	A238	2
27th order Harmonic subgroup	03 / 04	mV/0.1 mA	A23A	2
28th order Harmonic subgroup	03 / 04	mV/0.1 mA	A23C	2
29th order Harmonic subgroup	03 / 04	mV/0.1 mA	A23E	2
30th order Harmonic subgroup	03 / 04	mV/0.1 mA	A240	2
31st order Harmonic subgroup	03 / 04	mV/0.1 mA	A242	2
32nd order Harmonic subgroup	03 / 04	mV/0.1 mA	A244	2
33rd order Harmonic subgroup	03 / 04	mV/0.1 mA	A246	2
34th order Harmonic subgroup	03 / 04	mV/0.1 mA	A248	2
35th order Harmonic subgroup	03 / 04	mV/0.1 mA	A24A	2
36th order Harmonic subgroup	03 / 04	mV/0.1 mA	A24C	2
37th order Harmonic subgroup	03 / 04	mV/0.1 mA	A24E	2
38th order Harmonic subgroup	03 / 04	mV/0.1 mA	A250	2

Parameter	F. code (Hex)	M.U.	INTEGER	
			Register (Hex)	Words
HARMONICS ACCORDING TO IEC/EN 61000-4-30:2015 ED.3				
39th order Harmonic subgroup	03 / 04	mV/0.1 mA	A252	2
40th order Harmonic subgroup	03 / 04	mV/0.1 mA	A254	2
41st order Harmonic subgroup	03 / 04	mV/0.1 mA	A256	2
42nd order Harmonic subgroup	03 / 04	mV/0.1 mA	A258	2
43rd order Harmonic subgroup	03 / 04	mV/0.1 mA	A25A	2
44th order Harmonic subgroup	03 / 04	mV/0.1 mA	A25C	2
45th order Harmonic subgroup	03 / 04	mV/0.1 mA	A25E	2
46th order Harmonic subgroup	03 / 04	mV/0.1 mA	A260	2
47th order Harmonic subgroup	03 / 04	mV/0.1 mA	A262	2
48th order Harmonic subgroup	03 / 04	mV/0.1 mA	A264	2
49th order Harmonic subgroup	03 / 04	mV/0.1 mA	A266	2
50th order Harmonic subgroup	03 / 04	mV/0.1 mA	A268	2
Timestamp of the selected aggregation. Data format: compact BCD	03 / 04	10 ms	A26A	4
Flag of the selected aggregation. \$00=not flagged, \$01=flagged	03 / 04	-	A26E	2
10/12c block number in 10min aggregation	03 / 04	-	A270	2
150/180c block number in 10min aggregation	03 / 04	-	A272	2
Number of 10/12 cycles records	03 / 04	-	A274	2
RTC Lock. \$00=not locked, \$01=NTP, \$02=GPS	03 / 04	-	A276	2
DC Interharmonic subgroup	03 / 04	mV/0.1 mA	A278	2
1st order Interharmonic subgroup	03 / 04	mV/0.1 mA	A27A	2
2nd order Interharmonic subgroup	03 / 04	mV/0.1 mA	A27C	2
3rd order Interharmonic subgroup	03 / 04	mV/0.1 mA	A27E	2
4th order Interharmonic subgroup	03 / 04	mV/0.1 mA	A280	2
5th order Interharmonic subgroup	03 / 04	mV/0.1 mA	A282	2
6th order Interharmonic subgroup	03 / 04	mV/0.1 mA	A284	2
7th order Interharmonic subgroup	03 / 04	mV/0.1 mA	A286	2
8th order Interharmonic subgroup	03 / 04	mV/0.1 mA	A288	2
9th order Interharmonic subgroup	03 / 04	mV/0.1 mA	A28A	2
10th order Interharmonic subgroup	03 / 04	mV/0.1 mA	A28C	2
11th order Interharmonic subgroup	03 / 04	mV/0.1 mA	A28E	2
12th order Interharmonic subgroup	03 / 04	mV/0.1 mA	A290	2
13th order Interharmonic subgroup	03 / 04	mV/0.1 mA	A292	2
14th order Interharmonic subgroup	03 / 04	mV/0.1 mA	A294	2
15th order Interharmonic subgroup	03 / 04	mV/0.1 mA	A296	2
16th order Interharmonic subgroup	03 / 04	mV/0.1 mA	A298	2
17th order Interharmonic subgroup	03 / 04	mV/0.1 mA	A29A	2
18th order Interharmonic subgroup	03 / 04	mV/0.1 mA	A29C	2
19th order Interharmonic subgroup	03 / 04	mV/0.1 mA	A29E	2
20th order Interharmonic subgroup	03 / 04	mV/0.1 mA	A2A0	2
21st order Interharmonic subgroup	03 / 04	mV/0.1 mA	A2A2	2
22nd order Interharmonic subgroup	03 / 04	mV/0.1 mA	A2A4	2
23rd order Interharmonic subgroup	03 / 04	mV/0.1 mA	A2A6	2
24th order Interharmonic subgroup	03 / 04	mV/0.1 mA	A2A8	2
25th order Interharmonic subgroup	03 / 04	mV/0.1 mA	A2AA	2
26th order Interharmonic subgroup	03 / 04	mV/0.1 mA	A2AC	2
27th order Interharmonic subgroup	03 / 04	mV/0.1 mA	A2AE	2
28th order Interharmonic subgroup	03 / 04	mV/0.1 mA	A2B0	2
29th order Interharmonic subgroup	03 / 04	mV/0.1 mA	A2B2	2
30th order Interharmonic subgroup	03 / 04	mV/0.1 mA	A2B4	2
31st order Interharmonic subgroup	03 / 04	mV/0.1 mA	A2B6	2

Parameter	F. code (Hex)	M.U.	INTEGER	
			Register (Hex)	Words
HARMONICS ACCORDING TO IEC/EN 61000-4-30:2015 ED.3				
32nd order Interharmonic subgroup	03 / 04	mV/0.1 mA	A2B8	2
33rd order Interharmonic subgroup	03 / 04	mV/0.1 mA	A2BA	2
34th order Interharmonic subgroup	03 / 04	mV/0.1 mA	A2BC	2
35th order Interharmonic subgroup	03 / 04	mV/0.1 mA	A2BE	2
36th order Interharmonic subgroup	03 / 04	mV/0.1 mA	A2C0	2
37th order Interharmonic subgroup	03 / 04	mV/0.1 mA	A2C2	2
38th order Interharmonic subgroup	03 / 04	mV/0.1 mA	A2C4	2
39th order Interharmonic subgroup	03 / 04	mV/0.1 mA	A2C6	2
40th order Interharmonic subgroup	03 / 04	mV/0.1 mA	A2C8	2
41st order Interharmonic subgroup	03 / 04	mV/0.1 mA	A2CA	2
42nd order Interharmonic subgroup	03 / 04	mV/0.1 mA	A2CC	2
43rd order Interharmonic subgroup	03 / 04	mV/0.1 mA	A2CE	2
44th order Interharmonic subgroup	03 / 04	mV/0.1 mA	A2D0	2
45th order Interharmonic subgroup	03 / 04	mV/0.1 mA	A2D2	2
46th order Interharmonic subgroup	03 / 04	mV/0.1 mA	A2D4	2
47th order Interharmonic subgroup	03 / 04	mV/0.1 mA	A2D6	2
48th order Interharmonic subgroup	03 / 04	mV/0.1 mA	A2D8	2
49th order Interharmonic subgroup	03 / 04	mV/0.1 mA	A2DA	2
50th order Interharmonic subgroup	03 / 04	mV/0.1 mA	A2DC	2
Timestamp of the selected aggregation. Data format: compact BCD	03 / 04	10 ms	A2DE	4
Flag of the selected aggregation. \$00=not flagged, \$01=flagged	03 / 04	-	A2E2	2
10/12c block number in 10min aggregation	03 / 04	-	A2E4	2
150/180c block number in 10min aggregation	03 / 04	-	A2E6	2
Number of 10/12 cycles records	03 / 04	-	A2E8	2
RTC Lock. \$00=not locked, \$01=NTP, \$02=GPS	03 / 04	-	A2EA	2

Parameter	F. code (Hex)	M.U.	INTEGER	
			Register (Hex)	Words
EVENT INFORMATION ACCORDING TO IEC/EN 61000-4-30:2015 ED.3				
Dip/Swell event type. \$00=none, \$01=dip/sag, \$02=swell	03 / 04	-	A300	2
Dip/Swell event phases/lines. \$01=Phase 1 / Line 12, \$02=Phase 2 / Line 23, \$03=Phase 3 / Line 31	03 / 04	-	A302	2
Dip/Swell event start – time stamp. Data format: compact BCD	03 / 04	10 ms	A304	4
Dip/Swell event duration. Data format: compact BCD	03 / 04	10 ms	A308	2
Dip/Swell event depth/max value	03 / 04	mV	A30A	2
Interruption event phases/lines. \$01=Phase 1 / Line 12, \$02=Phase 2 / Line 23, \$03=Phase 3 / Line 31	03 / 04	-	A30C	2
Interruption event start - timestamp. Data format: compact BCD	03 / 04	-	A30E	4
Interruption event duration	03 / 04	10 ms	A312	2
Interruption event depth value	03 / 04	mV	A314	2
RVC event phases/lines. \$01=Phase 1 / Line 12, \$02=Phase 2 / Line 23, \$03=Phase 3 / Line 31	03 / 04	-	A316	2
RVC event start - time stamp. Data format: compact BCD	03 / 04	-	A318	4
RVC event duration. Data format: compact BCD	03 / 04	10 ms	A31C	2
RVC event depth value	03 / 04	mV	A31E	2
RVC event - difference between starting and ending steady-state	03 / 04	mV	A320	2
Number of 10/12c records	03 / 04	-	A322	2
RTC Lock. \$00=not locked, \$01=NTP, \$02=GPS	03 / 04	-	A324	2

Parameter	F. code (Hex)	M.U.	INTEGER	
			Register (Hex)	Words
10/12C AGGREGATED VALUES 20MIN BUFFER ACCORDING TO IEC/EN 61000-4-30:2015 ED.3				
Freeze block. \$00=unfreeze, \$01=freeze	03 / 04	-	A400	2
Timestamp for 10/12c aggregation. Data format: compact BCD	03 / 04	10 ms	A402	4
Phase 1 to Neutral Voltage for 10/12c aggregation	03 / 04	mV	A406	2
Phase 2 to Neutral Voltage for 10/12c aggregation	03 / 04	mV	A408	2
Phase 3 to Neutral Voltage for 10/12c aggregation	03 / 04	mV	A40A	2
Phase 1N (L12) Instantaneous Flicker for 10/12c aggregation	03 / 04	0.001	A40C	2
Phase 2N (L23) Instantaneous Flicker for 10/12c aggregation	03 / 04	0.001	A40E	2
Phase 3N (L31) Instantaneous Flicker for 10/12c aggregation	03 / 04	0.001	A410	2
Negative Sequence Unbalance Ratio for 10/12c aggregation	03 / 04	0.01%	A412	2
Zero Sequence Unbalance Ratio for 10/12c aggregation	03 / 04	0.01%	A414	2
Phase 1 to Neutral Voltage DC Harmonic subgroup	03 / 04	mV	A416	2
Phase 1 to Neutral Voltage DC Interharmonic subgroup	03 / 04	mV	A418	2
Phase 1 to Neutral Voltage 1st order Harmonic subgroup	03 / 04	mV	A41A	2
Phase 1 to Neutral Voltage 1st order Interharmonic subgroup	03 / 04	mV	A41C	2
Phase 1 to Neutral Voltage 2nd order Harmonic subgroup	03 / 04	mV	A41E	2
Phase 1 to Neutral Voltage 2nd order Interharmonic subgroup	03 / 04	mV	A420	2
Phase 1 to Neutral Voltage 3rd order Harmonic subgroup	03 / 04	mV	A422	2
Phase 1 to Neutral Voltage 3rd order Interharmonic subgroup	03 / 04	mV	A424	2
Phase 1 to Neutral Voltage 4th order Harmonic subgroup	03 / 04	mV	A426	2
Phase 1 to Neutral Voltage 4th order Interharmonic subgroup	03 / 04	mV	A428	2
Phase 1 to Neutral Voltage 5th order Harmonic subgroup	03 / 04	mV	A42A	2
Phase 1 to Neutral Voltage 5th order Interharmonic subgroup	03 / 04	mV	A42C	2
Phase 1 to Neutral Voltage 6th order Harmonic subgroup	03 / 04	mV	A42E	2
Phase 1 to Neutral Voltage 6th order Interharmonic subgroup	03 / 04	mV	A430	2
Phase 1 to Neutral Voltage 7th order Harmonic subgroup	03 / 04	mV	A432	2
Phase 1 to Neutral Voltage 7th order Interharmonic subgroup	03 / 04	mV	A434	2
Phase 1 to Neutral Voltage 8th order Harmonic subgroup	03 / 04	mV	A436	2
Phase 1 to Neutral Voltage 8th order Interharmonic subgroup	03 / 04	mV	A438	2
Phase 1 to Neutral Voltage 9th order Harmonic subgroup	03 / 04	mV	A43A	2
Phase 1 to Neutral Voltage 9th order Interharmonic subgroup	03 / 04	mV	A43C	2
Phase 1 to Neutral Voltage 10th order Harmonic subgroup	03 / 04	mV	A43E	2
Phase 1 to Neutral Voltage 10th order Interharmonic subgroup	03 / 04	mV	A440	2
Phase 1 to Neutral Voltage 11th order Harmonic subgroup	03 / 04	mV	A442	2
Phase 1 to Neutral Voltage 11th order Interharmonic subgroup	03 / 04	mV	A444	2
Phase 1 to Neutral Voltage 12th order Harmonic subgroup	03 / 04	mV	A446	2
Phase 1 to Neutral Voltage 12th order Interharmonic subgroup	03 / 04	mV	A448	2
Phase 1 to Neutral Voltage 13th order Harmonic subgroup	03 / 04	mV	A44A	2
Phase 1 to Neutral Voltage 13th order Interharmonic subgroup	03 / 04	mV	A44C	2
Phase 1 to Neutral Voltage 14th order Harmonic subgroup	03 / 04	mV	A44E	2
Phase 1 to Neutral Voltage 14th order Interharmonic subgroup	03 / 04	mV	A450	2
Phase 1 to Neutral Voltage 15th order Harmonic subgroup	03 / 04	mV	A452	2
Phase 1 to Neutral Voltage 15th order Interharmonic subgroup	03 / 04	mV	A454	2
Phase 1 to Neutral Voltage 16th order Harmonic subgroup	03 / 04	mV	A456	2
Phase 1 to Neutral Voltage 16th order Interharmonic subgroup	03 / 04	mV	A458	2
Phase 1 to Neutral Voltage 17th order Harmonic subgroup	03 / 04	mV	A45A	2
Phase 1 to Neutral Voltage 17th order Interharmonic subgroup	03 / 04	mV	A45C	2
Phase 1 to Neutral Voltage 18th order Harmonic subgroup	03 / 04	mV	A45E	2
Phase 1 to Neutral Voltage 18th order Interharmonic subgroup	03 / 04	mV	A460	2
Phase 1 to Neutral Voltage 19th order Harmonic subgroup	03 / 04	mV	A462	2
Phase 1 to Neutral Voltage 19th order Interharmonic subgroup	03 / 04	mV	A464	2

Parameter	F. code (Hex)	M.U.	INTEGER	
			Register (Hex)	Words
10/12C AGGREGATED VALUES 20MIN BUFFER ACCORDING TO IEC/EN 61000-4-30:2015 ED.3				
Phase 1 to Neutral Voltage 20th order Harmonic subgroup	03 / 04	mV	A466	2
Phase 1 to Neutral Voltage 20th order Interharmonic subgroup	03 / 04	mV	A468	2
Phase 1 to Neutral Voltage 21st order Harmonic subgroup	03 / 04	mV	A46A	2
Phase 1 to Neutral Voltage 21st order Interharmonic subgroup	03 / 04	mV	A46C	2
Phase 1 to Neutral Voltage 22nd order Harmonic subgroup	03 / 04	mV	A46E	2
Phase 1 to Neutral Voltage 22nd order Interharmonic subgroup	03 / 04	mV	A470	2
Phase 1 to Neutral Voltage 23rd order Harmonic subgroup	03 / 04	mV	A472	2
Phase 1 to Neutral Voltage 23rd order Interharmonic subgroup	03 / 04	mV	A474	2
Phase 1 to Neutral Voltage 24th order Harmonic subgroup	03 / 04	mV	A476	2
Phase 1 to Neutral Voltage 24th order Interharmonic subgroup	03 / 04	mV	A478	2
Phase 1 to Neutral Voltage 25th order Harmonic subgroup	03 / 04	mV	A47A	2
Phase 1 to Neutral Voltage 25th order Interharmonic subgroup	03 / 04	mV	A47C	2
Phase 1 to Neutral Voltage 26th order Harmonic subgroup	03 / 04	mV	A47E	2
Phase 1 to Neutral Voltage 26th order Interharmonic subgroup	03 / 04	mV	A480	2
Phase 1 to Neutral Voltage 27th order Harmonic subgroup	03 / 04	mV	A482	2
Phase 1 to Neutral Voltage 27th order Interharmonic subgroup	03 / 04	mV	A484	2
Phase 1 to Neutral Voltage 28th order Harmonic subgroup	03 / 04	mV	A486	2
Phase 1 to Neutral Voltage 28th order Interharmonic subgroup	03 / 04	mV	A488	2
Phase 1 to Neutral Voltage 29th order Harmonic subgroup	03 / 04	mV	A48A	2
Phase 1 to Neutral Voltage 29th order Interharmonic subgroup	03 / 04	mV	A48C	2
Phase 1 to Neutral Voltage 30th order Harmonic subgroup	03 / 04	mV	A48E	2
Phase 1 to Neutral Voltage 30th order Interharmonic subgroup	03 / 04	mV	A490	2
Phase 1 to Neutral Voltage 31st order Harmonic subgroup	03 / 04	mV	A492	2
Phase 1 to Neutral Voltage 31st order Interharmonic subgroup	03 / 04	mV	A494	2
Phase 1 to Neutral Voltage 32nd order Harmonic subgroup	03 / 04	mV	A496	2
Phase 1 to Neutral Voltage 32nd order Interharmonic subgroup	03 / 04	mV	A498	2
Phase 1 to Neutral Voltage 33rd order Harmonic subgroup	03 / 04	mV	A49A	2
Phase 1 to Neutral Voltage 33rd order Interharmonic subgroup	03 / 04	mV	A49C	2
Phase 1 to Neutral Voltage 34th order Harmonic subgroup	03 / 04	mV	A49E	2
Phase 1 to Neutral Voltage 34th order Interharmonic subgroup	03 / 04	mV	A4A0	2
Phase 1 to Neutral Voltage 35th order Harmonic subgroup	03 / 04	mV	A4A2	2
Phase 1 to Neutral Voltage 35th order Interharmonic subgroup	03 / 04	mV	A4A4	2
Phase 1 to Neutral Voltage 36th order Harmonic subgroup	03 / 04	mV	A4A6	2
Phase 1 to Neutral Voltage 36th order Interharmonic subgroup	03 / 04	mV	A4A8	2
Phase 1 to Neutral Voltage 37th order Harmonic subgroup	03 / 04	mV	A4AA	2
Phase 1 to Neutral Voltage 37th order Interharmonic subgroup	03 / 04	mV	A4AC	2
Phase 1 to Neutral Voltage 38th order Harmonic subgroup	03 / 04	mV	A4AE	2
Phase 1 to Neutral Voltage 38th order Interharmonic subgroup	03 / 04	mV	A4B0	2
Phase 1 to Neutral Voltage 39th order Harmonic subgroup	03 / 04	mV	A4B2	2
Phase 1 to Neutral Voltage 39th order Interharmonic subgroup	03 / 04	mV	A4B4	2
Phase 1 to Neutral Voltage 40th order Harmonic subgroup	03 / 04	mV	A4B6	2
Phase 1 to Neutral Voltage 40th order Interharmonic subgroup	03 / 04	mV	A4B8	2
Phase 1 to Neutral Voltage 41st order Harmonic subgroup	03 / 04	mV	A4BA	2
Phase 1 to Neutral Voltage 41st order Interharmonic subgroup	03 / 04	mV	A4BC	2
Phase 1 to Neutral Voltage 42nd order Harmonic subgroup	03 / 04	mV	A4BE	2
Phase 1 to Neutral Voltage 42nd order Interharmonic subgroup	03 / 04	mV	A4C0	2
Phase 1 to Neutral Voltage 43rd order Harmonic subgroup	03 / 04	mV	A4C2	2
Phase 1 to Neutral Voltage 43rd order Interharmonic subgroup	03 / 04	mV	A4C4	2
Phase 1 to Neutral Voltage 44th order Harmonic subgroup	03 / 04	mV	A4C6	2
Phase 1 to Neutral Voltage 44th order Interharmonic subgroup	03 / 04	mV	A4C8	2

Parameter	F. code (Hex)	M.U.	INTEGER	
			Register (Hex)	Words
10/12C AGGREGATED VALUES 20MIN BUFFER ACCORDING TO IEC/EN 61000-4-30:2015 ED.3				
Phase 1 to Neutral Voltage 45th order Harmonic subgroup	03 / 04	mV	A4CA	2
Phase 1 to Neutral Voltage 45th order Interharmonic subgroup	03 / 04	mV	A4CC	2
Phase 1 to Neutral Voltage 46th order Harmonic subgroup	03 / 04	mV	A4CE	2
Phase 1 to Neutral Voltage 46th order Interharmonic subgroup	03 / 04	mV	A4D0	2
Phase 1 to Neutral Voltage 47th order Harmonic subgroup	03 / 04	mV	A4D2	2
Phase 1 to Neutral Voltage 47th order Interharmonic subgroup	03 / 04	mV	A4D4	2
Phase 1 to Neutral Voltage 48th order Harmonic subgroup	03 / 04	mV	A4D6	2
Phase 1 to Neutral Voltage 48th order Interharmonic subgroup	03 / 04	mV	A4D8	2
Phase 1 to Neutral Voltage 49th order Harmonic subgroup	03 / 04	mV	A4DA	2
Phase 1 to Neutral Voltage 49th order Interharmonic subgroup	03 / 04	mV	A4DC	2
Phase 1 to Neutral Voltage 50th order Harmonic subgroup	03 / 04	mV	A4DE	2
Phase 1 to Neutral Voltage 50th order Interharmonic subgroup	03 / 04	mV	A4E0	2
Phase 2 to Neutral Voltage DC Harmonic subgroup	03 / 04	mV	A4E2	2
Phase 2 to Neutral Voltage DC Interharmonic subgroup	03 / 04	mV	A4E4	2
Phase 2 to Neutral Voltage 1st order Harmonic subgroup	03 / 04	mV	A4E6	2
Phase 2 to Neutral Voltage 1st order Interharmonic subgroup	03 / 04	mV	A4E8	2
Phase 2 to Neutral Voltage 2nd order Harmonic subgroup	03 / 04	mV	A4EA	2
Phase 2 to Neutral Voltage 2nd order Interharmonic subgroup	03 / 04	mV	A4EC	2
Phase 2 to Neutral Voltage 3rd order Harmonic subgroup	03 / 04	mV	A4EE	2
Phase 2 to Neutral Voltage 3rd order Interharmonic subgroup	03 / 04	mV	A4F0	2
Phase 2 to Neutral Voltage 4th order Harmonic subgroup	03 / 04	mV	A4F2	2
Phase 2 to Neutral Voltage 4th order Interharmonic subgroup	03 / 04	mV	A4F4	2
Phase 2 to Neutral Voltage 5th order Harmonic subgroup	03 / 04	mV	A4F6	2
Phase 2 to Neutral Voltage 5th order Interharmonic subgroup	03 / 04	mV	A4F8	2
Phase 2 to Neutral Voltage 6th order Harmonic subgroup	03 / 04	mV	A4FA	2
Phase 2 to Neutral Voltage 6th order Interharmonic subgroup	03 / 04	mV	A4FC	2
Phase 2 to Neutral Voltage 7th order Harmonic subgroup	03 / 04	mV	A4FE	2
Phase 2 to Neutral Voltage 7th order Interharmonic subgroup	03 / 04	mV	A500	2
Phase 2 to Neutral Voltage 8th order Harmonic subgroup	03 / 04	mV	A502	2
Phase 2 to Neutral Voltage 8th order Interharmonic subgroup	03 / 04	mV	A504	2
Phase 2 to Neutral Voltage 9th order Harmonic subgroup	03 / 04	mV	A506	2
Phase 2 to Neutral Voltage 9th order Interharmonic subgroup	03 / 04	mV	A508	2
Phase 2 to Neutral Voltage 10th order Harmonic subgroup	03 / 04	mV	A50A	2
Phase 2 to Neutral Voltage 10th order Interharmonic subgroup	03 / 04	mV	A50C	2
Phase 2 to Neutral Voltage 11th order Harmonic subgroup	03 / 04	mV	A50E	2
Phase 2 to Neutral Voltage 11th order Interharmonic subgroup	03 / 04	mV	A510	2
Phase 2 to Neutral Voltage 12th order Harmonic subgroup	03 / 04	mV	A512	2
Phase 2 to Neutral Voltage 12th order Interharmonic subgroup	03 / 04	mV	A514	2
Phase 2 to Neutral Voltage 13th order Harmonic subgroup	03 / 04	mV	A516	2
Phase 2 to Neutral Voltage 13th order Interharmonic subgroup	03 / 04	mV	A518	2
Phase 2 to Neutral Voltage 14th order Harmonic subgroup	03 / 04	mV	A51A	2
Phase 2 to Neutral Voltage 14th order Interharmonic subgroup	03 / 04	mV	A51C	2
Phase 2 to Neutral Voltage 15th order Harmonic subgroup	03 / 04	mV	A51E	2
Phase 2 to Neutral Voltage 15th order Interharmonic subgroup	03 / 04	mV	A520	2
Phase 2 to Neutral Voltage 16th order Harmonic subgroup	03 / 04	mV	A522	2
Phase 2 to Neutral Voltage 16th order Interharmonic subgroup	03 / 04	mV	A524	2
Phase 2 to Neutral Voltage 17th order Harmonic subgroup	03 / 04	mV	A526	2
Phase 2 to Neutral Voltage 17th order Interharmonic subgroup	03 / 04	mV	A528	2
Phase 2 to Neutral Voltage 18th order Harmonic subgroup	03 / 04	mV	A52A	2
Phase 2 to Neutral Voltage 18th order Interharmonic subgroup	03 / 04	mV	A52C	2

Parameter	F. code (Hex)	M.U.	INTEGER	
			Register (Hex)	Words
10/12C AGGREGATED VALUES 20MIN BUFFER ACCORDING TO IEC/EN 61000-4-30:2015 ED.3				
Phase 2 to Neutral Voltage 19th order Harmonic subgroup	03 / 04	mV	A52E	2
Phase 2 to Neutral Voltage 19th order Interharmonic subgroup	03 / 04	mV	A530	2
Phase 2 to Neutral Voltage 20th order Harmonic subgroup	03 / 04	mV	A532	2
Phase 2 to Neutral Voltage 20th order Interharmonic subgroup	03 / 04	mV	A534	2
Phase 2 to Neutral Voltage 21st order Harmonic subgroup	03 / 04	mV	A536	2
Phase 2 to Neutral Voltage 21st order Interharmonic subgroup	03 / 04	mV	A538	2
Phase 2 to Neutral Voltage 22nd order Harmonic subgroup	03 / 04	mV	A53A	2
Phase 2 to Neutral Voltage 22nd order Interharmonic subgroup	03 / 04	mV	A53C	2
Phase 2 to Neutral Voltage 23rd order Harmonic subgroup	03 / 04	mV	A53E	2
Phase 2 to Neutral Voltage 23rd order Interharmonic subgroup	03 / 04	mV	A540	2
Phase 2 to Neutral Voltage 24th order Harmonic subgroup	03 / 04	mV	A542	2
Phase 2 to Neutral Voltage 24th order Interharmonic subgroup	03 / 04	mV	A544	2
Phase 2 to Neutral Voltage 25th order Harmonic subgroup	03 / 04	mV	A546	2
Phase 2 to Neutral Voltage 25th order Interharmonic subgroup	03 / 04	mV	A548	2
Phase 2 to Neutral Voltage 26th order Harmonic subgroup	03 / 04	mV	A54A	2
Phase 2 to Neutral Voltage 26th order Interharmonic subgroup	03 / 04	mV	A54C	2
Phase 2 to Neutral Voltage 27th order Harmonic subgroup	03 / 04	mV	A54E	2
Phase 2 to Neutral Voltage 27th order Interharmonic subgroup	03 / 04	mV	A550	2
Phase 2 to Neutral Voltage 28th order Harmonic subgroup	03 / 04	mV	A552	2
Phase 2 to Neutral Voltage 28th order Interharmonic subgroup	03 / 04	mV	A554	2
Phase 2 to Neutral Voltage 29th order Harmonic subgroup	03 / 04	mV	A556	2
Phase 2 to Neutral Voltage 29th order Interharmonic subgroup	03 / 04	mV	A558	2
Phase 2 to Neutral Voltage 30th order Harmonic subgroup	03 / 04	mV	A55A	2
Phase 2 to Neutral Voltage 30th order Interharmonic subgroup	03 / 04	mV	A55C	2
Phase 2 to Neutral Voltage 31st order Harmonic subgroup	03 / 04	mV	A55E	2
Phase 2 to Neutral Voltage 31st order Interharmonic subgroup	03 / 04	mV	A560	2
Phase 2 to Neutral Voltage 32nd order Harmonic subgroup	03 / 04	mV	A562	2
Phase 2 to Neutral Voltage 32nd order Interharmonic subgroup	03 / 04	mV	A564	2
Phase 2 to Neutral Voltage 33rd order Harmonic subgroup	03 / 04	mV	A566	2
Phase 2 to Neutral Voltage 33rd order Interharmonic subgroup	03 / 04	mV	A568	2
Phase 2 to Neutral Voltage 34th order Harmonic subgroup	03 / 04	mV	A56A	2
Phase 2 to Neutral Voltage 34th order Interharmonic subgroup	03 / 04	mV	A56C	2
Phase 2 to Neutral Voltage 35th order Harmonic subgroup	03 / 04	mV	A56E	2
Phase 2 to Neutral Voltage 35th order Interharmonic subgroup	03 / 04	mV	A570	2
Phase 2 to Neutral Voltage 36th order Harmonic subgroup	03 / 04	mV	A572	2
Phase 2 to Neutral Voltage 36th order Interharmonic subgroup	03 / 04	mV	A574	2
Phase 2 to Neutral Voltage 37th order Harmonic subgroup	03 / 04	mV	A576	2
Phase 2 to Neutral Voltage 37th order Interharmonic subgroup	03 / 04	mV	A578	2
Phase 2 to Neutral Voltage 38th order Harmonic subgroup	03 / 04	mV	A57A	2
Phase 2 to Neutral Voltage 38th order Interharmonic subgroup	03 / 04	mV	A57C	2
Phase 2 to Neutral Voltage 39th order Harmonic subgroup	03 / 04	mV	A57E	2
Phase 2 to Neutral Voltage 39th order Interharmonic subgroup	03 / 04	mV	A580	2
Phase 2 to Neutral Voltage 40th order Harmonic subgroup	03 / 04	mV	A582	2
Phase 2 to Neutral Voltage 40th order Interharmonic subgroup	03 / 04	mV	A584	2
Phase 2 to Neutral Voltage 41st order Harmonic subgroup	03 / 04	mV	A586	2
Phase 2 to Neutral Voltage 41st order Interharmonic subgroup	03 / 04	mV	A588	2
Phase 2 to Neutral Voltage 42nd order Harmonic subgroup	03 / 04	mV	A58A	2
Phase 2 to Neutral Voltage 42nd order Interharmonic subgroup	03 / 04	mV	A58C	2
Phase 2 to Neutral Voltage 43rd order Harmonic subgroup	03 / 04	mV	A58E	2
Phase 2 to Neutral Voltage 43rd order Interharmonic subgroup	03 / 04	mV	A590	2

Parameter	F. code (Hex)	M.U.	INTEGER	
			Register (Hex)	Words
10/12C AGGREGATED VALUES 20MIN BUFFER ACCORDING TO IEC/EN 61000-4-30:2015 ED.3				
Phase 2 to Neutral Voltage 44th order Harmonic subgroup	03 / 04	mV	A592	2
Phase 2 to Neutral Voltage 44th order Interharmonic subgroup	03 / 04	mV	A594	2
Phase 2 to Neutral Voltage 45th order Harmonic subgroup	03 / 04	mV	A596	2
Phase 2 to Neutral Voltage 45th order Interharmonic subgroup	03 / 04	mV	A598	2
Phase 2 to Neutral Voltage 46th order Harmonic subgroup	03 / 04	mV	A59A	2
Phase 2 to Neutral Voltage 46th order Interharmonic subgroup	03 / 04	mV	A59C	2
Phase 2 to Neutral Voltage 47th order Harmonic subgroup	03 / 04	mV	A59E	2
Phase 2 to Neutral Voltage 47th order Interharmonic subgroup	03 / 04	mV	A5A0	2
Phase 2 to Neutral Voltage 48th order Harmonic subgroup	03 / 04	mV	A5A2	2
Phase 2 to Neutral Voltage 48th order Interharmonic subgroup	03 / 04	mV	A5A4	2
Phase 2 to Neutral Voltage 49th order Harmonic subgroup	03 / 04	mV	A5A6	2
Phase 2 to Neutral Voltage 49th order Interharmonic subgroup	03 / 04	mV	A5A8	2
Phase 2 to Neutral Voltage 50th order Harmonic subgroup	03 / 04	mV	A5AA	2
Phase 2 to Neutral Voltage 50th order Interharmonic subgroup	03 / 04	mV	A5AC	2
Phase 3 to Neutral Voltage DC Harmonic subgroup	03 / 04	mV	A5AE	2
Phase 3 to Neutral Voltage DC Interharmonic subgroup	03 / 04	mV	A5B0	2
Phase 3 to Neutral Voltage 1st order Harmonic subgroup	03 / 04	mV	A5B2	2
Phase 3 to Neutral Voltage 1st order Interharmonic subgroup	03 / 04	mV	A5B4	2
Phase 3 to Neutral Voltage 2nd order Harmonic subgroup	03 / 04	mV	A5B6	2
Phase 3 to Neutral Voltage 2nd order Interharmonic subgroup	03 / 04	mV	A5B8	2
Phase 3 to Neutral Voltage 3rd order Harmonic subgroup	03 / 04	mV	A5BA	2
Phase 3 to Neutral Voltage 3rd order Interharmonic subgroup	03 / 04	mV	A5BC	2
Phase 3 to Neutral Voltage 4th order Harmonic subgroup	03 / 04	mV	A5BE	2
Phase 3 to Neutral Voltage 4th order Interharmonic subgroup	03 / 04	mV	A5C0	2
Phase 3 to Neutral Voltage 5th order Harmonic subgroup	03 / 04	mV	A5C2	2
Phase 3 to Neutral Voltage 5th order Interharmonic subgroup	03 / 04	mV	A5C4	2
Phase 3 to Neutral Voltage 6th order Harmonic subgroup	03 / 04	mV	A5C6	2
Phase 3 to Neutral Voltage 6th order Interharmonic subgroup	03 / 04	mV	A5C8	2
Phase 3 to Neutral Voltage 7th order Harmonic subgroup	03 / 04	mV	A5CA	2
Phase 3 to Neutral Voltage 7th order Interharmonic subgroup	03 / 04	mV	A5CC	2
Phase 3 to Neutral Voltage 8th order Harmonic subgroup	03 / 04	mV	A5CE	2
Phase 3 to Neutral Voltage 8th order Interharmonic subgroup	03 / 04	mV	A5D0	2
Phase 3 to Neutral Voltage 9th order Harmonic subgroup	03 / 04	mV	A5D2	2
Phase 3 to Neutral Voltage 9th order Interharmonic subgroup	03 / 04	mV	A5D4	2
Phase 3 to Neutral Voltage 10th order Harmonic subgroup	03 / 04	mV	A5D6	2
Phase 3 to Neutral Voltage 10th order Interharmonic subgroup	03 / 04	mV	A5D8	2
Phase 3 to Neutral Voltage 11th order Harmonic subgroup	03 / 04	mV	A5DA	2
Phase 3 to Neutral Voltage 11th order Interharmonic subgroup	03 / 04	mV	A5DC	2
Phase 3 to Neutral Voltage 12th order Harmonic subgroup	03 / 04	mV	A5DE	2
Phase 3 to Neutral Voltage 12th order Interharmonic subgroup	03 / 04	mV	A5E0	2
Phase 3 to Neutral Voltage 13th order Harmonic subgroup	03 / 04	mV	A5E2	2
Phase 3 to Neutral Voltage 13th order Interharmonic subgroup	03 / 04	mV	A5E4	2
Phase 3 to Neutral Voltage 14th order Harmonic subgroup	03 / 04	mV	A5E6	2
Phase 3 to Neutral Voltage 14th order Interharmonic subgroup	03 / 04	mV	A5E8	2
Phase 3 to Neutral Voltage 15th order Harmonic subgroup	03 / 04	mV	A5EA	2
Phase 3 to Neutral Voltage 15th order Interharmonic subgroup	03 / 04	mV	A5EC	2
Phase 3 to Neutral Voltage 16th order Harmonic subgroup	03 / 04	mV	A5EE	2
Phase 3 to Neutral Voltage 16th order Interharmonic subgroup	03 / 04	mV	A5F0	2
Phase 3 to Neutral Voltage 17th order Harmonic subgroup	03 / 04	mV	A5F2	2
Phase 3 to Neutral Voltage 17th order Interharmonic subgroup	03 / 04	mV	A5F4	2

Parameter	F. code (Hex)	M.U.	INTEGER	
			Register (Hex)	Words
10/12C AGGREGATED VALUES 20MIN BUFFER ACCORDING TO IEC/EN 61000-4-30:2015 ED.3				
Phase 3 to Neutral Voltage 18th order Harmonic subgroup	03 / 04	mV	A5F6	2
Phase 3 to Neutral Voltage 18th order Interharmonic subgroup	03 / 04	mV	A5F8	2
Phase 3 to Neutral Voltage 19th order Harmonic subgroup	03 / 04	mV	A5FA	2
Phase 3 to Neutral Voltage 19th order Interharmonic subgroup	03 / 04	mV	A5FC	2
Phase 3 to Neutral Voltage 20th order Harmonic subgroup	03 / 04	mV	A5FE	2
Phase 3 to Neutral Voltage 20th order Interharmonic subgroup	03 / 04	mV	A600	2
Phase 3 to Neutral Voltage 21st order Harmonic subgroup	03 / 04	mV	A602	2
Phase 3 to Neutral Voltage 21st order Interharmonic subgroup	03 / 04	mV	A604	2
Phase 3 to Neutral Voltage 22nd order Harmonic subgroup	03 / 04	mV	A606	2
Phase 3 to Neutral Voltage 22nd order Interharmonic subgroup	03 / 04	mV	A608	2
Phase 3 to Neutral Voltage 23rd order Harmonic subgroup	03 / 04	mV	A60A	2
Phase 3 to Neutral Voltage 23rd order Interharmonic subgroup	03 / 04	mV	A60C	2
Phase 3 to Neutral Voltage 24th order Harmonic subgroup	03 / 04	mV	A60E	2
Phase 3 to Neutral Voltage 24th order Interharmonic subgroup	03 / 04	mV	A610	2
Phase 3 to Neutral Voltage 25th order Harmonic subgroup	03 / 04	mV	A612	2
Phase 3 to Neutral Voltage 25th order Interharmonic subgroup	03 / 04	mV	A614	2
Phase 3 to Neutral Voltage 26th order Harmonic subgroup	03 / 04	mV	A616	2
Phase 3 to Neutral Voltage 26th order Interharmonic subgroup	03 / 04	mV	A618	2
Phase 3 to Neutral Voltage 27th order Harmonic subgroup	03 / 04	mV	A61A	2
Phase 3 to Neutral Voltage 27th order Interharmonic subgroup	03 / 04	mV	A61C	2
Phase 3 to Neutral Voltage 28th order Harmonic subgroup	03 / 04	mV	A61E	2
Phase 3 to Neutral Voltage 28th order Interharmonic subgroup	03 / 04	mV	A620	2
Phase 3 to Neutral Voltage 29th order Harmonic subgroup	03 / 04	mV	A622	2
Phase 3 to Neutral Voltage 29th order Interharmonic subgroup	03 / 04	mV	A624	2
Phase 3 to Neutral Voltage 30th order Harmonic subgroup	03 / 04	mV	A626	2
Phase 3 to Neutral Voltage 30th order Interharmonic subgroup	03 / 04	mV	A628	2
Phase 3 to Neutral Voltage 31st order Harmonic subgroup	03 / 04	mV	A62A	2
Phase 3 to Neutral Voltage 31st order Interharmonic subgroup	03 / 04	mV	A62C	2
Phase 3 to Neutral Voltage 32nd order Harmonic subgroup	03 / 04	mV	A62E	2
Phase 3 to Neutral Voltage 32nd order Interharmonic subgroup	03 / 04	mV	A630	2
Phase 3 to Neutral Voltage 33rd order Harmonic subgroup	03 / 04	mV	A632	2
Phase 3 to Neutral Voltage 33rd order Interharmonic subgroup	03 / 04	mV	A634	2
Phase 3 to Neutral Voltage 34th order Harmonic subgroup	03 / 04	mV	A636	2
Phase 3 to Neutral Voltage 34th order Interharmonic subgroup	03 / 04	mV	A638	2
Phase 3 to Neutral Voltage 35th order Harmonic subgroup	03 / 04	mV	A63A	2
Phase 3 to Neutral Voltage 35th order Interharmonic subgroup	03 / 04	mV	A63C	2
Phase 3 to Neutral Voltage 36th order Harmonic subgroup	03 / 04	mV	A63E	2
Phase 3 to Neutral Voltage 36th order Interharmonic subgroup	03 / 04	mV	A640	2
Phase 3 to Neutral Voltage 37th order Harmonic subgroup	03 / 04	mV	A642	2
Phase 3 to Neutral Voltage 37th order Interharmonic subgroup	03 / 04	mV	A644	2
Phase 3 to Neutral Voltage 38th order Harmonic subgroup	03 / 04	mV	A646	2
Phase 3 to Neutral Voltage 38th order Interharmonic subgroup	03 / 04	mV	A648	2
Phase 3 to Neutral Voltage 39th order Harmonic subgroup	03 / 04	mV	A64A	2
Phase 3 to Neutral Voltage 39th order Interharmonic subgroup	03 / 04	mV	A64C	2
Phase 3 to Neutral Voltage 40th order Harmonic subgroup	03 / 04	mV	A64E	2
Phase 3 to Neutral Voltage 40th order Interharmonic subgroup	03 / 04	mV	A650	2
Phase 3 to Neutral Voltage 41st order Harmonic subgroup	03 / 04	mV	A652	2
Phase 3 to Neutral Voltage 41st order Interharmonic subgroup	03 / 04	mV	A654	2
Phase 3 to Neutral Voltage 42nd order Harmonic subgroup	03 / 04	mV	A656	2
Phase 3 to Neutral Voltage 42nd order Interharmonic subgroup	03 / 04	mV	A658	2

Parameter	F. code (Hex)	M.U.	INTEGER	
			Register (Hex)	Words
10/12C AGGREGATED VALUES 20MIN BUFFER ACCORDING TO IEC/EN 61000-4-30:2015 ED.3				
Phase 3 to Neutral Voltage 43rd order Harmonic subgroup	03 / 04	mV	A65A	2
Phase 3 to Neutral Voltage 43rd order Interharmonic subgroup	03 / 04	mV	A65C	2
Phase 3 to Neutral Voltage 44th order Harmonic subgroup	03 / 04	mV	A65E	2
Phase 3 to Neutral Voltage 44th order Interharmonic subgroup	03 / 04	mV	A660	2
Phase 3 to Neutral Voltage 45th order Harmonic subgroup	03 / 04	mV	A662	2
Phase 3 to Neutral Voltage 45th order Interharmonic subgroup	03 / 04	mV	A664	2
Phase 3 to Neutral Voltage 46th order Harmonic subgroup	03 / 04	mV	A666	2
Phase 3 to Neutral Voltage 46th order Interharmonic subgroup	03 / 04	mV	A668	2
Phase 3 to Neutral Voltage 47th order Harmonic subgroup	03 / 04	mV	A66A	2
Phase 3 to Neutral Voltage 47th order Interharmonic subgroup	03 / 04	mV	A66C	2
Phase 3 to Neutral Voltage 48th order Harmonic subgroup	03 / 04	mV	A66E	2
Phase 3 to Neutral Voltage 48th order Interharmonic subgroup	03 / 04	mV	A670	2
Phase 3 to Neutral Voltage 49th order Harmonic subgroup	03 / 04	mV	A672	2
Phase 3 to Neutral Voltage 49th order Interharmonic subgroup	03 / 04	mV	A674	2
Phase 3 to Neutral Voltage 50th order Harmonic subgroup	03 / 04	mV	A676	2
Phase 3 to Neutral Voltage 50th order Interharmonic subgroup	03 / 04	mV	A678	2
Phase 1 to Neutral Voltage Underdeviation	03 / 04	mV	A67A	2
Phase 1 to Neutral Voltage Overdeviation	03 / 04	mV	A67C	2
Phase 2 to Neutral Voltage Underdeviation	03 / 04	mV	A67E	2
Phase 2 to Neutral Voltage Overdeviation	03 / 04	mV	A680	2
Phase 3 to Neutral Voltage Underdeviation	03 / 04	mV	A682	2
Phase 3 to Neutral Voltage Overdeviation	03 / 04	mV	A684	2
Line 1 to 2 Voltage Underdeviation	03 / 04	mV	A686	2
Line 1 to 2 Voltage Overdeviation	03 / 04	mV	A688	2
Line 2 to 3 Voltage Underdeviation	03 / 04	mV	A68A	2
Line 2 to 3 Voltage Overdeviation	03 / 04	mV	A68C	2
Line 3 to 1 Voltage Underdeviation	03 / 04	mV	A68E	2
Line 3 to 1 Voltage Overdeviation	03 / 04	mV	A690	2
Phase 1 Current for 10/12c aggregation	03 / 04	0.1 mA	A692	2
Phase 2 Current for 10/12c aggregation	03 / 04	0.1 mA	A694	2
Phase 3 Current for 10/12c aggregation	03 / 04	0.1 mA	A696	2
Current Negative Sequence Unbalance Ratio for 10/12c aggregation	03 / 04	0.01%	A698	2
Current Zero Sequence Unbalance Ratio for 10/12c aggregation	03 / 04	0.01%	A69A	2
Phase 1 Current DC Harmonic subgroup	03 / 04	0.1 mA	A69C	2
Phase 1 Current DC Interharmonic subgroup	03 / 04	0.1 mA	A69E	2
Phase 1 Current 1st order Harmonic subgroup	03 / 04	0.1 mA	A6A0	2
Phase 1 Current 1st order Interharmonic subgroup	03 / 04	0.1 mA	A6A2	2
Phase 1 Current 2nd order Harmonic subgroup	03 / 04	0.1 mA	A6A4	2
Phase 1 Current 2nd order Interharmonic subgroup	03 / 04	0.1 mA	A6A6	2
Phase 1 Current 3rd order Harmonic subgroup	03 / 04	0.1 mA	A6A8	2
Phase 1 Current 3rd order Interharmonic subgroup	03 / 04	0.1 mA	A6AA	2
Phase 1 Current 4th order Harmonic subgroup	03 / 04	0.1 mA	A6AC	2
Phase 1 Current 4th order Interharmonic subgroup	03 / 04	0.1 mA	A6AE	2
Phase 1 Current 5th order Harmonic subgroup	03 / 04	0.1 mA	A6B0	2
Phase 1 Current 5th order Interharmonic subgroup	03 / 04	0.1 mA	A6B2	2
Phase 1 Current 6th order Harmonic subgroup	03 / 04	0.1 mA	A6B4	2
Phase 1 Current 6th order Interharmonic subgroup	03 / 04	0.1 mA	A6B6	2
Phase 1 Current 7th order Harmonic subgroup	03 / 04	0.1 mA	A6B8	2
Phase 1 Current 7th order Interharmonic subgroup	03 / 04	0.1 mA	A6BA	2
Phase 1 Current 8th order Harmonic subgroup	03 / 04	0.1 mA	A6BC	2

Parameter	F. code (Hex)	M.U.	INTEGER	
			Register (Hex)	Words
10/12C AGGREGATED VALUES 20MIN BUFFER ACCORDING TO IEC/EN 61000-4-30:2015 ED.3				
Phase 1 Current 8th order Interharmonic subgroup	03 / 04	0.1 mA	A6BE	2
Phase 1 Current 9th order Harmonic subgroup	03 / 04	0.1 mA	A6C0	2
Phase 1 Current 9th order Interharmonic subgroup	03 / 04	0.1 mA	A6C2	2
Phase 1 Current 10th order Harmonic subgroup	03 / 04	0.1 mA	A6C4	2
Phase 1 Current 10th order Interharmonic subgroup	03 / 04	0.1 mA	A6C6	2
Phase 1 Current 11th order Harmonic subgroup	03 / 04	0.1 mA	A6C8	2
Phase 1 Current 11th order Interharmonic subgroup	03 / 04	0.1 mA	A6CA	2
Phase 1 Current 12th order Harmonic subgroup	03 / 04	0.1 mA	A6CC	2
Phase 1 Current 12th order Interharmonic subgroup	03 / 04	0.1 mA	A6CE	2
Phase 1 Current 13th order Harmonic subgroup	03 / 04	0.1 mA	A6D0	2
Phase 1 Current 13th order Interharmonic subgroup	03 / 04	0.1 mA	A6D2	2
Phase 1 Current 14th order Harmonic subgroup	03 / 04	0.1 mA	A6D4	2
Phase 1 Current 14th order Interharmonic subgroup	03 / 04	0.1 mA	A6D6	2
Phase 1 Current 15th order Harmonic subgroup	03 / 04	0.1 mA	A6D8	2
Phase 1 Current 15th order Interharmonic subgroup	03 / 04	0.1 mA	A6DA	2
Phase 1 Current 16th order Harmonic subgroup	03 / 04	0.1 mA	A6DC	2
Phase 1 Current 16th order Interharmonic subgroup	03 / 04	0.1 mA	A6DE	2
Phase 1 Current 17th order Harmonic subgroup	03 / 04	0.1 mA	A6E0	2
Phase 1 Current 17th order Interharmonic subgroup	03 / 04	0.1 mA	A6E2	2
Phase 1 Current 18th order Harmonic subgroup	03 / 04	0.1 mA	A6E4	2
Phase 1 Current 18th order Interharmonic subgroup	03 / 04	0.1 mA	A6E6	2
Phase 1 Current 19th order Harmonic subgroup	03 / 04	0.1 mA	A6E8	2
Phase 1 Current 19th order Interharmonic subgroup	03 / 04	0.1 mA	A6EA	2
Phase 1 Current 20th order Harmonic subgroup	03 / 04	0.1 mA	A6EC	2
Phase 1 Current 20th order Interharmonic subgroup	03 / 04	0.1 mA	A6EE	2
Phase 1 Current 21st order Harmonic subgroup	03 / 04	0.1 mA	A6F0	2
Phase 1 Current 21st order Interharmonic subgroup	03 / 04	0.1 mA	A6F2	2
Phase 1 Current 22nd order Harmonic subgroup	03 / 04	0.1 mA	A6F4	2
Phase 1 Current 22nd order Interharmonic subgroup	03 / 04	0.1 mA	A6F6	2
Phase 1 Current 23rd order Harmonic subgroup	03 / 04	0.1 mA	A6F8	2
Phase 1 Current 23rd order Interharmonic subgroup	03 / 04	0.1 mA	A6FA	2
Phase 1 Current 24th order Harmonic subgroup	03 / 04	0.1 mA	A6FC	2
Phase 1 Current 24th order Interharmonic subgroup	03 / 04	0.1 mA	A6FE	2
Phase 1 Current 25th order Harmonic subgroup	03 / 04	0.1 mA	A700	2
Phase 1 Current 25th order Interharmonic subgroup	03 / 04	0.1 mA	A702	2
Phase 1 Current 26th order Harmonic subgroup	03 / 04	0.1 mA	A704	2
Phase 1 Current 26th order Interharmonic subgroup	03 / 04	0.1 mA	A706	2
Phase 1 Current 27th order Harmonic subgroup	03 / 04	0.1 mA	A708	2
Phase 1 Current 27th order Interharmonic subgroup	03 / 04	0.1 mA	A70A	2
Phase 1 Current 28th order Harmonic subgroup	03 / 04	0.1 mA	A70C	2
Phase 1 Current 28th order Interharmonic subgroup	03 / 04	0.1 mA	A70E	2
Phase 1 Current 29th order Harmonic subgroup	03 / 04	0.1 mA	A710	2
Phase 1 Current 29th order Interharmonic subgroup	03 / 04	0.1 mA	A712	2
Phase 1 Current 30th order Harmonic subgroup	03 / 04	0.1 mA	A714	2
Phase 1 Current 30th order Interharmonic subgroup	03 / 04	0.1 mA	A716	2
Phase 1 Current 31st order Harmonic subgroup	03 / 04	0.1 mA	A718	2
Phase 1 Current 31st order Interharmonic subgroup	03 / 04	0.1 mA	A71A	2
Phase 1 Current 32nd order Harmonic subgroup	03 / 04	0.1 mA	A71C	2
Phase 1 Current 32nd order Interharmonic subgroup	03 / 04	0.1 mA	A71E	2
Phase 1 Current 33rd order Harmonic subgroup	03 / 04	0.1 mA	A720	2

Parameter	F. code (Hex)	M.U.	INTEGER	
			Register (Hex)	Words
10/12C AGGREGATED VALUES 20MIN BUFFER ACCORDING TO IEC/EN 61000-4-30:2015 ED.3				
Phase 1 Current 33rd order Interharmonic subgroup	03 / 04	0.1 mA	A722	2
Phase 1 Current 34th order Harmonic subgroup	03 / 04	0.1 mA	A724	2
Phase 1 Current 34th order Interharmonic subgroup	03 / 04	0.1 mA	A726	2
Phase 1 Current 35th order Harmonic subgroup	03 / 04	0.1 mA	A728	2
Phase 1 Current 35th order Interharmonic subgroup	03 / 04	0.1 mA	A72A	2
Phase 1 Current 36th order Harmonic subgroup	03 / 04	0.1 mA	A72C	2
Phase 1 Current 36th order Interharmonic subgroup	03 / 04	0.1 mA	A72E	2
Phase 1 Current 37th order Harmonic subgroup	03 / 04	0.1 mA	A730	2
Phase 1 Current 37th order Interharmonic subgroup	03 / 04	0.1 mA	A732	2
Phase 1 Current 38th order Harmonic subgroup	03 / 04	0.1 mA	A734	2
Phase 1 Current 38th order Interharmonic subgroup	03 / 04	0.1 mA	A736	2
Phase 1 Current 39th order Harmonic subgroup	03 / 04	0.1 mA	A738	2
Phase 1 Current 39th order Interharmonic subgroup	03 / 04	0.1 mA	A73A	2
Phase 1 Current 40th order Harmonic subgroup	03 / 04	0.1 mA	A73C	2
Phase 1 Current 40th order Interharmonic subgroup	03 / 04	0.1 mA	A73E	2
Phase 1 Current 41st order Harmonic subgroup	03 / 04	0.1 mA	A740	2
Phase 1 Current 41st order Interharmonic subgroup	03 / 04	0.1 mA	A742	2
Phase 1 Current 42nd order Harmonic subgroup	03 / 04	0.1 mA	A744	2
Phase 1 Current 42nd order Interharmonic subgroup	03 / 04	0.1 mA	A746	2
Phase 1 Current 43rd order Harmonic subgroup	03 / 04	0.1 mA	A748	2
Phase 1 Current 43rd order Interharmonic subgroup	03 / 04	0.1 mA	A74A	2
Phase 1 Current 44th order Harmonic subgroup	03 / 04	0.1 mA	A74C	2
Phase 1 Current 44th order Interharmonic subgroup	03 / 04	0.1 mA	A74E	2
Phase 1 Current 45th order Harmonic subgroup	03 / 04	0.1 mA	A750	2
Phase 1 Current 45th order Interharmonic subgroup	03 / 04	0.1 mA	A752	2
Phase 1 Current 46th order Harmonic subgroup	03 / 04	0.1 mA	A754	2
Phase 1 Current 46th order Interharmonic subgroup	03 / 04	0.1 mA	A756	2
Phase 1 Current 47th order Harmonic subgroup	03 / 04	0.1 mA	A758	2
Phase 1 Current 47th order Interharmonic subgroup	03 / 04	0.1 mA	A75A	2
Phase 1 Current 48th order Harmonic subgroup	03 / 04	0.1 mA	A75C	2
Phase 1 Current 48th order Interharmonic subgroup	03 / 04	0.1 mA	A75E	2
Phase 1 Current 49th order Harmonic subgroup	03 / 04	0.1 mA	A760	2
Phase 1 Current 49th order Interharmonic subgroup	03 / 04	0.1 mA	A762	2
Phase 1 Current 50th order Harmonic subgroup	03 / 04	0.1 mA	A764	2
Phase 1 Current 50th order Interharmonic subgroup	03 / 04	0.1 mA	A766	2
Phase 2 Current DC Harmonic subgroup	03 / 04	0.1 mA	A768	2
Phase 2 Current DC Interharmonic subgroup	03 / 04	0.1 mA	A76A	2
Phase 2 Current 1st order Harmonic subgroup	03 / 04	0.1 mA	A76C	2
Phase 2 Current 1st order Interharmonic subgroup	03 / 04	0.1 mA	A76E	2
Phase 2 Current 2nd order Harmonic subgroup	03 / 04	0.1 mA	A770	2
Phase 2 Current 2nd order Interharmonic subgroup	03 / 04	0.1 mA	A772	2
Phase 2 Current 3rd order Harmonic subgroup	03 / 04	0.1 mA	A774	2
Phase 2 Current 3rd order Interharmonic subgroup	03 / 04	0.1 mA	A776	2
Phase 2 Current 4th order Harmonic subgroup	03 / 04	0.1 mA	A778	2
Phase 2 Current 4th order Interharmonic subgroup	03 / 04	0.1 mA	A77A	2
Phase 2 Current 5th order Harmonic subgroup	03 / 04	0.1 mA	A77C	2
Phase 2 Current 5th order Interharmonic subgroup	03 / 04	0.1 mA	A77E	2
Phase 2 Current 6th order Harmonic subgroup	03 / 04	0.1 mA	A780	2
Phase 2 Current 6th order Interharmonic subgroup	03 / 04	0.1 mA	A782	2
Phase 2 Current 7th order Harmonic subgroup	03 / 04	0.1 mA	A784	2

Parameter	F. code (Hex)	M.U.	INTEGER	
			Register (Hex)	Words
10/12C AGGREGATED VALUES 20MIN BUFFER ACCORDING TO IEC/EN 61000-4-30:2015 ED.3				
Phase 2 Current 7th order Interharmonic subgroup	03 / 04	0.1 mA	A786	2
Phase 2 Current 8th order Harmonic subgroup	03 / 04	0.1 mA	A788	2
Phase 2 Current 8th order Interharmonic subgroup	03 / 04	0.1 mA	A78A	2
Phase 2 Current 9th order Harmonic subgroup	03 / 04	0.1 mA	A78C	2
Phase 2 Current 9th order Interharmonic subgroup	03 / 04	0.1 mA	A78E	2
Phase 2 Current 10th order Harmonic subgroup	03 / 04	0.1 mA	A790	2
Phase 2 Current 10th order Interharmonic subgroup	03 / 04	0.1 mA	A792	2
Phase 2 Current 11th order Harmonic subgroup	03 / 04	0.1 mA	A794	2
Phase 2 Current 11th order Interharmonic subgroup	03 / 04	0.1 mA	A796	2
Phase 2 Current 12th order Harmonic subgroup	03 / 04	0.1 mA	A798	2
Phase 2 Current 12th order Interharmonic subgroup	03 / 04	0.1 mA	A79A	2
Phase 2 Current 13th order Harmonic subgroup	03 / 04	0.1 mA	A79C	2
Phase 2 Current 13th order Interharmonic subgroup	03 / 04	0.1 mA	A79E	2
Phase 2 Current 14th order Harmonic subgroup	03 / 04	0.1 mA	A7A0	2
Phase 2 Current 14th order Interharmonic subgroup	03 / 04	0.1 mA	A7A2	2
Phase 2 Current 15th order Harmonic subgroup	03 / 04	0.1 mA	A7A4	2
Phase 2 Current 15th order Interharmonic subgroup	03 / 04	0.1 mA	A7A6	2
Phase 2 Current 16th order Harmonic subgroup	03 / 04	0.1 mA	A7A8	2
Phase 2 Current 16th order Interharmonic subgroup	03 / 04	0.1 mA	A7AA	2
Phase 2 Current 17th order Harmonic subgroup	03 / 04	0.1 mA	A7AC	2
Phase 2 Current 17th order Interharmonic subgroup	03 / 04	0.1 mA	A7AE	2
Phase 2 Current 18th order Harmonic subgroup	03 / 04	0.1 mA	A7B0	2
Phase 2 Current 18th order Interharmonic subgroup	03 / 04	0.1 mA	A7B2	2
Phase 2 Current 19th order Harmonic subgroup	03 / 04	0.1 mA	A7B4	2
Phase 2 Current 19th order Interharmonic subgroup	03 / 04	0.1 mA	A7B6	2
Phase 2 Current 20th order Harmonic subgroup	03 / 04	0.1 mA	A7B8	2
Phase 2 Current 20th order Interharmonic subgroup	03 / 04	0.1 mA	A7BA	2
Phase 2 Current 21st order Harmonic subgroup	03 / 04	0.1 mA	A7BC	2
Phase 2 Current 21st order Interharmonic subgroup	03 / 04	0.1 mA	A7BE	2
Phase 2 Current 22nd order Harmonic subgroup	03 / 04	0.1 mA	A7C0	2
Phase 2 Current 22nd order Interharmonic subgroup	03 / 04	0.1 mA	A7C2	2
Phase 2 Current 23rd order Harmonic subgroup	03 / 04	0.1 mA	A7C4	2
Phase 2 Current 23rd order Interharmonic subgroup	03 / 04	0.1 mA	A7C6	2
Phase 2 Current 24th order Harmonic subgroup	03 / 04	0.1 mA	A7C8	2
Phase 2 Current 24th order Interharmonic subgroup	03 / 04	0.1 mA	A7CA	2
Phase 2 Current 25th order Harmonic subgroup	03 / 04	0.1 mA	A7CC	2
Phase 2 Current 25th order Interharmonic subgroup	03 / 04	0.1 mA	A7CE	2
Phase 2 Current 26th order Harmonic subgroup	03 / 04	0.1 mA	A7D0	2
Phase 2 Current 26th order Interharmonic subgroup	03 / 04	0.1 mA	A7D2	2
Phase 2 Current 27th order Harmonic subgroup	03 / 04	0.1 mA	A7D4	2
Phase 2 Current 27th order Interharmonic subgroup	03 / 04	0.1 mA	A7D6	2
Phase 2 Current 28th order Harmonic subgroup	03 / 04	0.1 mA	A7D8	2
Phase 2 Current 28th order Interharmonic subgroup	03 / 04	0.1 mA	A7DA	2
Phase 2 Current 29th order Harmonic subgroup	03 / 04	0.1 mA	A7DC	2
Phase 2 Current 29th order Interharmonic subgroup	03 / 04	0.1 mA	A7DE	2
Phase 2 Current 30th order Harmonic subgroup	03 / 04	0.1 mA	A7E0	2
Phase 2 Current 30th order Interharmonic subgroup	03 / 04	0.1 mA	A7E2	2
Phase 2 Current 31st order Harmonic subgroup	03 / 04	0.1 mA	A7E4	2
Phase 2 Current 31st order Interharmonic subgroup	03 / 04	0.1 mA	A7E6	2
Phase 2 Current 32nd order Harmonic subgroup	03 / 04	0.1 mA	A7E8	2

Parameter	F. code (Hex)	M.U.	INTEGER	
			Register (Hex)	Words
10/12C AGGREGATED VALUES 20MIN BUFFER ACCORDING TO IEC/EN 61000-4-30:2015 ED.3				
Phase 2 Current 32nd order Interharmonic subgroup	03 / 04	0.1 mA	A7EA	2
Phase 2 Current 33rd order Harmonic subgroup	03 / 04	0.1 mA	A7EC	2
Phase 2 Current 33rd order Interharmonic subgroup	03 / 04	0.1 mA	A7EE	2
Phase 2 Current 34th order Harmonic subgroup	03 / 04	0.1 mA	A7F0	2
Phase 2 Current 34th order Interharmonic subgroup	03 / 04	0.1 mA	A7F2	2
Phase 2 Current 35th order Harmonic subgroup	03 / 04	0.1 mA	A7F4	2
Phase 2 Current 35th order Interharmonic subgroup	03 / 04	0.1 mA	A7F6	2
Phase 2 Current 36th order Harmonic subgroup	03 / 04	0.1 mA	A7F8	2
Phase 2 Current 36th order Interharmonic subgroup	03 / 04	0.1 mA	A7FA	2
Phase 2 Current 37th order Harmonic subgroup	03 / 04	0.1 mA	A7FC	2
Phase 2 Current 37th order Interharmonic subgroup	03 / 04	0.1 mA	A7FE	2
Phase 2 Current 38th order Harmonic subgroup	03 / 04	0.1 mA	A800	2
Phase 2 Current 38th order Interharmonic subgroup	03 / 04	0.1 mA	A802	2
Phase 2 Current 39th order Harmonic subgroup	03 / 04	0.1 mA	A804	2
Phase 2 Current 39th order Interharmonic subgroup	03 / 04	0.1 mA	A806	2
Phase 2 Current 40th order Harmonic subgroup	03 / 04	0.1 mA	A808	2
Phase 2 Current 40th order Interharmonic subgroup	03 / 04	0.1 mA	A80A	2
Phase 2 Current 41st order Harmonic subgroup	03 / 04	0.1 mA	A80C	2
Phase 2 Current 41st order Interharmonic subgroup	03 / 04	0.1 mA	A80E	2
Phase 2 Current 42nd order Harmonic subgroup	03 / 04	0.1 mA	A810	2
Phase 2 Current 42nd order Interharmonic subgroup	03 / 04	0.1 mA	A812	2
Phase 2 Current 43rd order Harmonic subgroup	03 / 04	0.1 mA	A814	2
Phase 2 Current 43rd order Interharmonic subgroup	03 / 04	0.1 mA	A816	2
Phase 2 Current 44th order Harmonic subgroup	03 / 04	0.1 mA	A818	2
Phase 2 Current 44th order Interharmonic subgroup	03 / 04	0.1 mA	A81A	2
Phase 2 Current 45th order Harmonic subgroup	03 / 04	0.1 mA	A81C	2
Phase 2 Current 45th order Interharmonic subgroup	03 / 04	0.1 mA	A81E	2
Phase 2 Current 46th order Harmonic subgroup	03 / 04	0.1 mA	A820	2
Phase 2 Current 46th order Interharmonic subgroup	03 / 04	0.1 mA	A822	2
Phase 2 Current 47th order Harmonic subgroup	03 / 04	0.1 mA	A824	2
Phase 2 Current 47th order Interharmonic subgroup	03 / 04	0.1 mA	A826	2
Phase 2 Current 48th order Harmonic subgroup	03 / 04	0.1 mA	A828	2
Phase 2 Current 48th order Interharmonic subgroup	03 / 04	0.1 mA	A82A	2
Phase 2 Current 49th order Harmonic subgroup	03 / 04	0.1 mA	A82C	2
Phase 2 Current 49th order Interharmonic subgroup	03 / 04	0.1 mA	A82E	2
Phase 2 Current 50th order Harmonic subgroup	03 / 04	0.1 mA	A830	2
Phase 2 Current 50th order Interharmonic subgroup	03 / 04	0.1 mA	A832	2
Phase 3 Current DC Harmonic subgroup	03 / 04	0.1 mA	A834	2
Phase 3 Current DC Interharmonic subgroup	03 / 04	0.1 mA	A836	2
Phase 3 Current 1st order Harmonic subgroup	03 / 04	0.1 mA	A838	2
Phase 3 Current 1st order Interharmonic subgroup	03 / 04	0.1 mA	A83A	2
Phase 3 Current 2nd order Harmonic subgroup	03 / 04	0.1 mA	A83C	2
Phase 3 Current 2nd order Interharmonic subgroup	03 / 04	0.1 mA	A83E	2
Phase 3 Current 3rd order Harmonic subgroup	03 / 04	0.1 mA	A840	2
Phase 3 Current 3rd order Interharmonic subgroup	03 / 04	0.1 mA	A842	2
Phase 3 Current 4th order Harmonic subgroup	03 / 04	0.1 mA	A844	2
Phase 3 Current 4th order Interharmonic subgroup	03 / 04	0.1 mA	A846	2
Phase 3 Current 5th order Harmonic subgroup	03 / 04	0.1 mA	A848	2
Phase 3 Current 5th order Interharmonic subgroup	03 / 04	0.1 mA	A84A	2
Phase 3 Current 6th order Harmonic subgroup	03 / 04	0.1 mA	A84C	2

Parameter	F. code (Hex)	M.U.	INTEGER	
			Register (Hex)	Words
10/12C AGGREGATED VALUES 20MIN BUFFER ACCORDING TO IEC/EN 61000-4-30:2015 ED.3				
Phase 3 Current 6th order Interharmonic subgroup	03 / 04	0.1 mA	A84E	2
Phase 3 Current 7th order Harmonic subgroup	03 / 04	0.1 mA	A850	2
Phase 3 Current 7th order Interharmonic subgroup	03 / 04	0.1 mA	A852	2
Phase 3 Current 8th order Harmonic subgroup	03 / 04	0.1 mA	A854	2
Phase 3 Current 8th order Interharmonic subgroup	03 / 04	0.1 mA	A856	2
Phase 3 Current 9th order Harmonic subgroup	03 / 04	0.1 mA	A858	2
Phase 3 Current 9th order Interharmonic subgroup	03 / 04	0.1 mA	A85A	2
Phase 3 Current 10th order Harmonic subgroup	03 / 04	0.1 mA	A85C	2
Phase 3 Current 10th order Interharmonic subgroup	03 / 04	0.1 mA	A85E	2
Phase 3 Current 11th order Harmonic subgroup	03 / 04	0.1 mA	A860	2
Phase 3 Current 11th order Interharmonic subgroup	03 / 04	0.1 mA	A862	2
Phase 3 Current 12th order Harmonic subgroup	03 / 04	0.1 mA	A864	2
Phase 3 Current 12th order Interharmonic subgroup	03 / 04	0.1 mA	A866	2
Phase 3 Current 13th order Harmonic subgroup	03 / 04	0.1 mA	A868	2
Phase 3 Current 13th order Interharmonic subgroup	03 / 04	0.1 mA	A86A	2
Phase 3 Current 14th order Harmonic subgroup	03 / 04	0.1 mA	A86C	2
Phase 3 Current 14th order Interharmonic subgroup	03 / 04	0.1 mA	A86E	2
Phase 3 Current 15th order Harmonic subgroup	03 / 04	0.1 mA	A870	2
Phase 3 Current 15th order Interharmonic subgroup	03 / 04	0.1 mA	A872	2
Phase 3 Current 16th order Harmonic subgroup	03 / 04	0.1 mA	A874	2
Phase 3 Current 16th order Interharmonic subgroup	03 / 04	0.1 mA	A876	2
Phase 3 Current 17th order Harmonic subgroup	03 / 04	0.1 mA	A878	2
Phase 3 Current 17th order Interharmonic subgroup	03 / 04	0.1 mA	A87A	2
Phase 3 Current 18th order Harmonic subgroup	03 / 04	0.1 mA	A87C	2
Phase 3 Current 18th order Interharmonic subgroup	03 / 04	0.1 mA	A87E	2
Phase 3 Current 19th order Harmonic subgroup	03 / 04	0.1 mA	A880	2
Phase 3 Current 19th order Interharmonic subgroup	03 / 04	0.1 mA	A882	2
Phase 3 Current 20th order Harmonic subgroup	03 / 04	0.1 mA	A884	2
Phase 3 Current 20th order Interharmonic subgroup	03 / 04	0.1 mA	A886	2
Phase 3 Current 21st order Harmonic subgroup	03 / 04	0.1 mA	A888	2
Phase 3 Current 21st order Interharmonic subgroup	03 / 04	0.1 mA	A88A	2
Phase 3 Current 22nd order Harmonic subgroup	03 / 04	0.1 mA	A88C	2
Phase 3 Current 22nd order Interharmonic subgroup	03 / 04	0.1 mA	A88E	2
Phase 3 Current 23rd order Harmonic subgroup	03 / 04	0.1 mA	A890	2
Phase 3 Current 23rd order Interharmonic subgroup	03 / 04	0.1 mA	A892	2
Phase 3 Current 24th order Harmonic subgroup	03 / 04	0.1 mA	A894	2
Phase 3 Current 24th order Interharmonic subgroup	03 / 04	0.1 mA	A896	2
Phase 3 Current 25th order Harmonic subgroup	03 / 04	0.1 mA	A898	2
Phase 3 Current 25th order Interharmonic subgroup	03 / 04	0.1 mA	A89A	2
Phase 3 Current 26th order Harmonic subgroup	03 / 04	0.1 mA	A89C	2
Phase 3 Current 26th order Interharmonic subgroup	03 / 04	0.1 mA	A89E	2
Phase 3 Current 27th order Harmonic subgroup	03 / 04	0.1 mA	A8A0	2
Phase 3 Current 27th order Interharmonic subgroup	03 / 04	0.1 mA	A8A2	2
Phase 3 Current 28th order Harmonic subgroup	03 / 04	0.1 mA	A8A4	2
Phase 3 Current 28th order Interharmonic subgroup	03 / 04	0.1 mA	A8A6	2
Phase 3 Current 29th order Harmonic subgroup	03 / 04	0.1 mA	A8A8	2
Phase 3 Current 29th order Interharmonic subgroup	03 / 04	0.1 mA	A8AA	2
Phase 3 Current 30th order Harmonic subgroup	03 / 04	0.1 mA	A8AC	2
Phase 3 Current 30th order Interharmonic subgroup	03 / 04	0.1 mA	A8AE	2
Phase 3 Current 31st order Harmonic subgroup	03 / 04	0.1 mA	A8B0	2

Parameter	F. code (Hex)	M.U.	INTEGER	
			Register (Hex)	Words
10/12C AGGREGATED VALUES 20MIN BUFFER ACCORDING TO IEC/EN 61000-4-30:2015 ED.3				
Phase 3 Current 31st order Interharmonic subgroup	03 / 04	0.1 mA	A8B2	2
Phase 3 Current 32nd order Harmonic subgroup	03 / 04	0.1 mA	A8B4	2
Phase 3 Current 32nd order Interharmonic subgroup	03 / 04	0.1 mA	A8B6	2
Phase 3 Current 33rd order Harmonic subgroup	03 / 04	0.1 mA	A8B8	2
Phase 3 Current 33rd order Interharmonic subgroup	03 / 04	0.1 mA	A8BA	2
Phase 3 Current 34th order Harmonic subgroup	03 / 04	0.1 mA	A8BC	2
Phase 3 Current 34th order Interharmonic subgroup	03 / 04	0.1 mA	A8BE	2
Phase 3 Current 35th order Harmonic subgroup	03 / 04	0.1 mA	A8C0	2
Phase 3 Current 35th order Interharmonic subgroup	03 / 04	0.1 mA	A8C2	2
Phase 3 Current 36th order Harmonic subgroup	03 / 04	0.1 mA	A8C4	2
Phase 3 Current 36th order Interharmonic subgroup	03 / 04	0.1 mA	A8C6	2
Phase 3 Current 37th order Harmonic subgroup	03 / 04	0.1 mA	A8C8	2
Phase 3 Current 37th order Interharmonic subgroup	03 / 04	0.1 mA	A8CA	2
Phase 3 Current 38th order Harmonic subgroup	03 / 04	0.1 mA	A8CC	2
Phase 3 Current 38th order Interharmonic subgroup	03 / 04	0.1 mA	A8CE	2
Phase 3 Current 39th order Harmonic subgroup	03 / 04	0.1 mA	A8D0	2
Phase 3 Current 39th order Interharmonic subgroup	03 / 04	0.1 mA	A8D2	2
Phase 3 Current 40th order Harmonic subgroup	03 / 04	0.1 mA	A8D4	2
Phase 3 Current 40th order Interharmonic subgroup	03 / 04	0.1 mA	A8D6	2
Phase 3 Current 41st order Harmonic subgroup	03 / 04	0.1 mA	A8D8	2
Phase 3 Current 41st order Interharmonic subgroup	03 / 04	0.1 mA	A8DA	2
Phase 3 Current 42nd order Harmonic subgroup	03 / 04	0.1 mA	A8DC	2
Phase 3 Current 42nd order Interharmonic subgroup	03 / 04	0.1 mA	A8DE	2
Phase 3 Current 43rd order Harmonic subgroup	03 / 04	0.1 mA	A8E0	2
Phase 3 Current 43rd order Interharmonic subgroup	03 / 04	0.1 mA	A8E2	2
Phase 3 Current 44th order Harmonic subgroup	03 / 04	0.1 mA	A8E4	2
Phase 3 Current 44th order Interharmonic subgroup	03 / 04	0.1 mA	A8E6	2
Phase 3 Current 45th order Harmonic subgroup	03 / 04	0.1 mA	A8E8	2
Phase 3 Current 45th order Interharmonic subgroup	03 / 04	0.1 mA	A8EA	2
Phase 3 Current 46th order Harmonic subgroup	03 / 04	0.1 mA	A8EC	2
Phase 3 Current 46th order Interharmonic subgroup	03 / 04	0.1 mA	A8EE	2
Phase 3 Current 47th order Harmonic subgroup	03 / 04	0.1 mA	A8F0	2
Phase 3 Current 47th order Interharmonic subgroup	03 / 04	0.1 mA	A8F2	2
Phase 3 Current 48th order Harmonic subgroup	03 / 04	0.1 mA	A8F4	2
Phase 3 Current 48th order Interharmonic subgroup	03 / 04	0.1 mA	A8F6	2
Phase 3 Current 49th order Harmonic subgroup	03 / 04	0.1 mA	A8F8	2
Phase 3 Current 49th order Interharmonic subgroup	03 / 04	0.1 mA	A8FA	2
Phase 3 Current 50th order Harmonic subgroup	03 / 04	0.1 mA	A8FC	2
Phase 3 Current 50th order Interharmonic subgroup	03 / 04	0.1 mA	A8FE	2
Timestamp for 10/12c aggregation. Data format: compact BCD	03 / 04	10 ms	A900	4
Flag for 10/12c aggregation. \$00=not flagged, \$01=flagged	03 / 04	-	A904	2

5. READING COMMAND EXAMPLES

In this chapter, some reading command examples are described.

5.1. MODBUS RTU

The following tables show some reading examples in MODBUS RTU.

Values contained both in Query and Response messages are in hex format.

CURRENT VALUE READING

Query example: 01 03 00 20 00 0A 0E A4

Example	Byte	Description
01	-	Slave address
03	-	Function code
00	High	Starting register
20	Low	
00	High	10 words to be read
0A	Low	
0E	High	CRC
A4	Low	

Response example: 01 03 14 00 00 09 99 00 00 09 9F 00 00 09 90 00 00 09 98 00 00 00 19 C0 70

Example	Byte	Description
01	-	Slave address
03	-	Function code
14	-	20 data bytes
00	High	2457 mA phase 1 current (I1)
00	Low	
09	High	
99	Low	
00	High	2463 mA phase 2 current (I2)
00	Low	
09	High	
9F	Low	
00	High	2448 mA phase 3 current (I3)
00	Low	
09	High	
90	Low	
00	High	2456 mA system current (I Σ)
00	Low	
09	High	
98	Low	
00	High	25 mA neutral current (I4)
00	Low	
00	High	
19	Low	
C0	High	CRC
70	Low	

1° STEP: set the harmonic parameter**Command example: 01 10 01 00 00 02 04 00 00 00 07 FD BF**

Example	Byte	Description
01	-	Slave address
10	-	Function code
01	High	Starting register
00	Low	
00	High	2 word to be written
02	Low	
04	-	4 data bytes
00	High	Set the phase 1 current parameter for the following harmonic reading
00	Low	
00	High	
07	Low	
FD	High	CRC
BF	Low	

Response example: 01 10 01 00 00 02 34 40**2° STEP: perform the data download by a reading command****Query example: 01 03 01 28 00 28 20 C4**

Example	Byte	Description
01	-	Slave address
03	-	Function code
01	High	Starting register
28	Low	
00	High	40 words to be read
28	Low	
20	High	CRC
C4	Low	

Response example:

01 03 50

00 00 00 00 00 00 89 FC 00 00 00 00 00 00 3A FE 00 00 00 00 00 00 7A 30 00 00 00 00 00 62 C8
 00 00 00 00 00 00 01 83 00 00 00 00 00 00 6E 87 00 00 00 00 00 00 19 B8 00 00 00 00 00 00 2A 06
 00 00 00 00 00 00 17 C1 00 00 00 00 00 00 6A DC D3 0C

Example	Byte	Description
01	-	Slave address
03	-	Function code
50	-	80 data bytes
00	High	0 mA
00	Low	
00	High	1st Harmonic Component of Phase 1 Current - Magnitude
00	Low	
00	High	35324 mA
00	Low	
89	High	1st Harmonic Component of Phase 1 Current - Phase
FC	Low	
00	High	0 mA
00	Low	
00	High	Phase 1 Current Interharmonic Group 1 - Bin 1 magnitude
00	Low	
00	High	15102 mA
00	Low	
3A	High	Phase 1 Current Interharmonic Group 1 - Bin 1 phase
FE	Low	
00	High	0 mA
00	Low	
00	High	Phase 1 Current Interharmonic Group 1 - Bin 2 magnitude
00	Low	
00	High	31280 mA
00	Low	
7A	High	Phase 1 Current Interharmonic Group 1 - Bin 2 phase
30	Low	
00	High	0 mA
00	Low	
00	High	Phase 1 Current Interharmonic Group 1 - Bin 3 magnitude
00	Low	
00	High	25288 mA
00	Low	
62	High	Phase 1 Current Interharmonic Group 1 - Bin 3 phase
C8	Low	
00	High	0 mA
00	Low	
00	High	Phase 1 Current Interharmonic Group 1 - Bin 4 magnitude
00	Low	
00	High	27356 mA
00	Low	
6A	High	Phase 1 Current Interharmonic Group 1 - Bin 9 phase
DC	Low	
D3	High	CRC
0C	Low	

5.2. MODBUS TCP

The following tables show some reading examples in MODBUS TCP.

Values contained both in Query and Response messages are in hex format.

CURRENT VALUE READING

Query example: 01 00 00 00 00 06 01 03 00 20 00 0A

Example	Byte	Description
01	-	Transaction ID
00	High	Protocol ID
00	Low	
00	High	
00	Low	
06	-	6 data bytes
01	-	Unit ID
03	-	Function code
00	High	Starting register
20	Low	
00	High	10 words to be read
0A	Low	

Response example: 01 00 00 00 00 03 14 00 00 09 99 00 00 09 9F 00 00 09 90 00 00 09 98 00 00 00 19

Example	Byte	Description
01	-	Transaction ID
00	High	Protocol ID
00	Low	
00	High	
00	Low	
0C	-	12 data bytes
01	-	Unit ID
03	-	Function code
14	-	20 reading bytes
00	High	2457 mA phase 1 current (I1)
00	Low	
09	High	
99	Low	
00	High	2463 mA phase 2 current (I2)
00	Low	
09	High	
9F	Low	
00	High	2448 mA phase 3 current (I3)
00	Low	
09	High	
90	Low	
00	High	2456 mA system current (I Σ)
00	Low	
09	High	
98	Low	
00	High	25 mA neutral current (I4)
00	Low	
00	High	
19	Low	

1° STEP: set the harmonic parameter**Command example: 01 00 00 00 00 0B 01 10 01 00 00 02 04 00 00 00 07**

Example	Byte	Description
01	-	Transaction ID
00	High	Protocol ID
00	Low	
00	High	
00	Low	
0B	-	11 data bytes
01	-	Unit ID
10	-	Function code
01	High	Starting register
00	Low	
00	High	2 word to be written
02	Low	
04	-	4 bytes to be written
00	High	Set the phase 1 current parameter for the following harmonic reading
07	Low	

Response example: 01 00 00 00 00 06 01 10 01 00 00 00 00 02

Example	Byte	Description
01	-	Transaction ID
00	High	Protocol ID
00	Low	
00	High	
00	Low	
06	-	6 data bytes
01	-	Unit ID
10	-	Function code
01	High	Starting register
00	Low	
00	High	Command successfully sent
00	Low	
00	High	
02	Low	

2° STEP: perform the data download by a reading command**Query example: 01 00 00 00 00 06 01 04 01 28 00 28**

Example	Byte	Description
01	-	Transaction ID
00	High	Protocol ID
00	Low	
00	High	
00	Low	
06	-	6 data bytes
01	-	Unit ID
04	-	Function code
01	High	Starting register
28	Low	
00	High	40 words to be read
28	Low	

Response example:

01 00 00 00 00 53 01 04 50
 00 00 00 00 00 00 89 FC 00 00 00 00 00 00 3A FE 00 00 00 00 00 00 7A 30 00 00 00 00 00 62 C8
 00 00 00 00 00 00 01 83 00 00 00 00 00 00 6E 87 00 00 00 00 00 00 19 B8 00 00 00 00 00 00 2A 06
 00 00 00 00 00 00 17 C1 00 00 00 00 00 00 6A DC

Example	Byte	Description
01	-	Transaction ID
00	High	Protocol ID
00	Low	
00	High	
00	Low	
00	Low	
53	-	83 data bytes
01	-	Unit ID
04	-	Function code
50	-	80 reading bytes
00	High	0 mA
00	Low	
00	High	1st Harmonic Component of Phase 1 Current - Magnitude
00	Low	
00	High	35324 mA
00	Low	
89	High	1st Harmonic Component of Phase 1 Current - Phase
FC	Low	
00	High	0 mA
00	Low	
00	High	Phase 1 Current Interharmonic Group 1 - Bin 1 magnitude
00	Low	
00	High	15102 mA
00	Low	
3A	High	Phase 1 Current Interharmonic Group 1 - Bin 1 phase
FE	Low	
00	High	0 mA
00	Low	
00	High	Phase 1 Current Interharmonic Group 1 - Bin 2 magnitude
00	Low	
00	High	31280 mA
00	Low	
7A	High	Phase 1 Current Interharmonic Group 1 - Bin 2 phase
30	Low	
00	High	0 mA
00	Low	
00	High	Phase 1 Current Interharmonic Group 1 - Bin 3 magnitude
00	Low	
00	High	25288 mA
00	Low	
62	High	Phase 1 Current Interharmonic Group 1 - Bin 3 phase
C8	Low	
00	High	0 mA
00	Low	
00	High	Phase 1 Current Interharmonic Group 1 - Bin 4 magnitude
00	Low	
00	High	27356 mA
00	Low	
6A	High	Phase 1 Current Interharmonic Group 1 - Bin 9 phase
DC	Low	

CORPORATE HQ CONTACT:
SOCOMECSAS
1-4 RUE DE WESTHOUSE
67235 BENFELD, FRANCE

www.socomec.com

Non contractual document. © 2023, Socomec SAS. All rights reserved.



546169D



 **socomec**
Innovative Power Solutions