



542934F

ATyS p M

40 - 160 A (4P)
AUTOMATIC TRANSFER
SWITCHING EQUIPMENT

Preliminary operations

Check the following upon delivery and after removal of the packaging:

- Packaging and contents are in good condition.
- The product reference corresponds to the order.
- Contents should include:
Qty 1 x ATyS M
Qty 1 x Emergency handle extension rod
Qty 1 x Set of terminals
Quick Start Guide

Warning

⚠ Risk of electrocution, burns or injury to persons and / or damage to equipment. This Quick Start is intended for personnel trained in the installation and commissioning of this product. For further details refer to the product instruction manual available on the SOCOMECC website.

- This product must always be installed and commissioned by qualified and approved personnel.
 - Maintenance and servicing operations should be performed by trained and authorized personnel.
 - Do not handle any control or power cables connected to the product when voltage may be, or may become present on the product, directly through the mains or indirectly through external circuits.
 - Always use an appropriate voltage detection device to confirm the absence of voltage.
 - Ensure that no metal objects are allowed to fall in the cabinet (risk of electrical arcing).
- Failure to observe good engineering practices as well as to follow these safety instructions may expose the user and others to serious injury or death.

⚠ Risk of damaging the device

In case the product is dropped or damaged in any way it is recommended to replace the complete product. Installation standards must be respected.

Accessories

- Bridging bars 125A or 160A.
- Control voltage transformer (400Vac → 230Vac).
- Voltage sensing and power supply tap.
- Terminal shrouds.
- Auxilliary contact blocks.
- Polycarbonate enclosure.
- Polycarbonate extension box.
- Power Connection Terminals.
- ATyS D10 remote display unit.
- ATyS D20 remote control and display unit.



CORPORATE HQ CONTACT:
SOCOMECC SAS,
1-4 RUE DE WESTHOUSE,
67235 BENFELD, FRANCE

www.socomec.com
To download, brochures,
catalogues and technical manuals

Installation and Commissioning

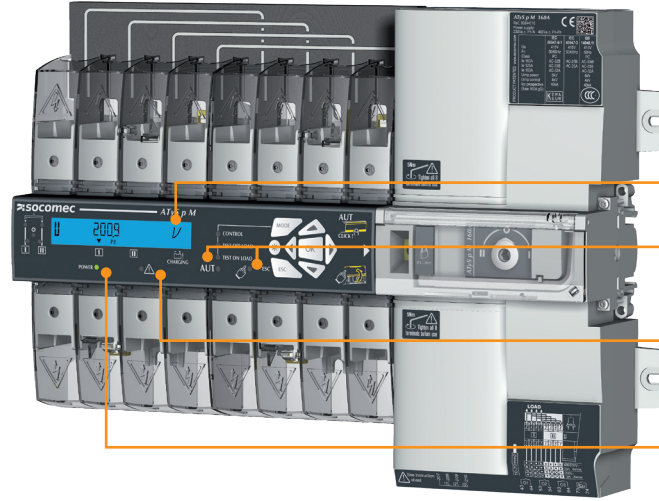
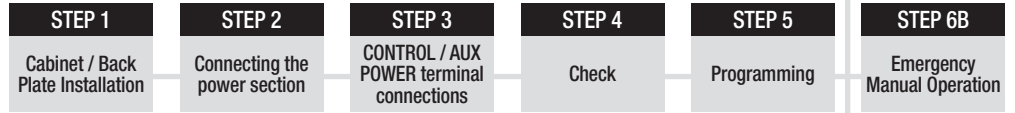

Capacitor charging
Return to zero capacitor charge. While the indicator is flashing, the return to 0 function is unavailable.

Operating mode
MANU: 1 yellow LED for MANU mode active.
AUT: 1 green LED for AUTO mode active.

Fault LED
1 red LED to indicate the status of the product. Open and close the AUT/MAN cover to reset the fault.

Power Supply LED
1 green LED
- Always off: both power supplies off or software error if other indicators are on.
- Always on: product power supply on.

1 Installation

⚠ Caution: Ensure that the product is installed on a flat rigid surface.

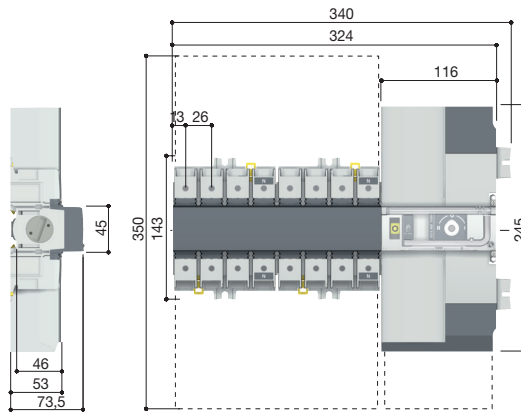

Recommended orientation

Recommended

OK

OK

OK

OK

OK

OK

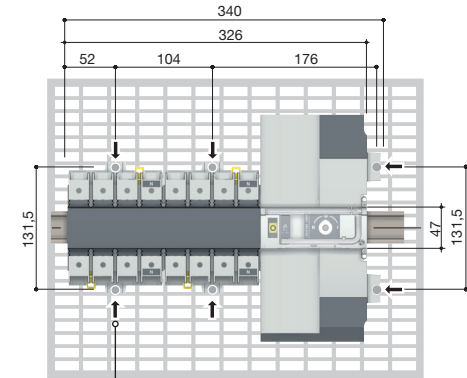

6 mounting brackets - 6x M6 screw - 2,5 Nm

⚠ Tighten to avoid movement on the DIN rail.

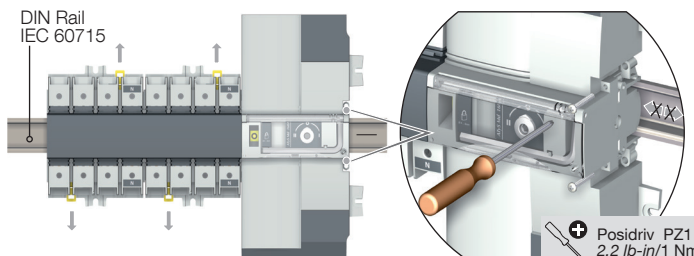

Padlocking configuration

⚠ The ATyS M is delivered with padlocking configured to the O position.

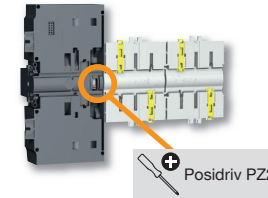
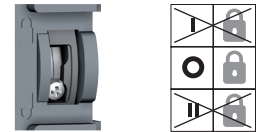

⚠ To allow padlocking in all positions (I - O - II), configure the ATyS M as follows before installation. (Screw is located at the back of the product).

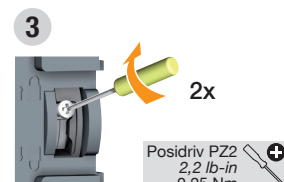
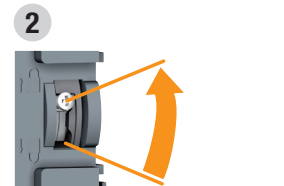
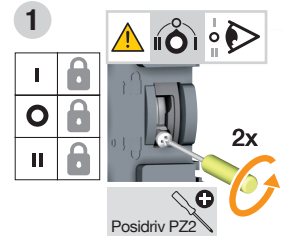

2 Power Terminal Connections

⚠ It is essential to tighten all used terminals, with cables and/or bridging bars, before use.

Load side bridging bar.
40 - 125 A: 1309 4006
160 A: 1309 4016



Source supply side

Hexagonal Metric Allen size 4
44.2 lb-in / 5 Nm

10 to 70 mm²
15mm

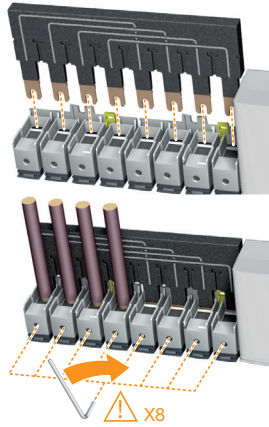

Voltage taps provide $2x \leq 1.5\text{mm}^2$ connections. They can be fitted in any terminals on the source supply side. Do not use on the load side when equipped with a bridging bar.

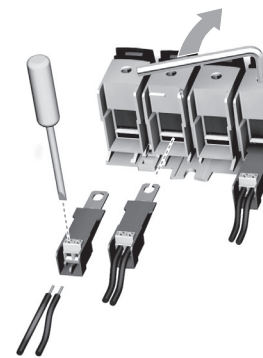

Slotted head 3.5 mm
3.9 lb-in / 0.45 Nm

0.5 to 2.5 mm²
0.5 to 1.5 mm²
6 mm

3 CONTROL / AUX POWER Terminals and wiring

TYPE	TERMINAL NO.	DESCRIPTION	CHARACTERISTICS	RECOMMENDED CONNECTION CROSS-SECTION
Inputs	207	Common point for inputs	Do not connect to any power supply Supply from the product	0.5 to 2.5 mm ² (rigid)
	208	I1: programmable input		
	209	I2: programmable input		
	210	I3: programmable input		
Outputs	43/44	O1: programmable output	Resistive load 2A 30Vdc 0.5A 230Vac Pmax: 60W or 115VA Umax: 30Vdc or 230Vac	0.5 to 1.5 mm ² (stranded)
	53/54	O2: programmable output		
	63/64	O3: programmable output		
	73/74	G: generator stat signal		
Remote interface connection	RJ	ATyS D10/D20 human/machine interface	Maximum distance 3 m	RJ45 8/8 straight cable Cat. 5
Serial connection (specific version)	RS485	Connection RS485 0: interconnection of cable shielding upstream and downstream of RS485 bus -: negative terminal of RS485 bus +: positive terminal of RS485 bus	RS485 bus insulated	LiCY shielded twisted pair, 0.5 to 2.5 mm ²

TYPE	TERMINAL NO.	STATUS OF THE CONTACT	DESCRIPTION	OUTPUT CHARACTERISTICS	RECOMMENDED CONNECTION CROSS-SECTION
Auxiliary contact block 1309 1001	11/12/14	11 — 14 12	Changeover switch in position I	250V AC 5A AC1 - 30 Vdc 5A	0.5 to 2.5 mm ² (rigid)
	21/22/24	21 — 24 22	Changeover switch in position II		
	01/02/04	01 — 04 02	Changeover switch in position 0		
Auxiliary contact block 1309 1011	11/12/14	11 — 14 12	Changeover switch in position I	250V AC 5A AC1 - 30 Vdc 5A	0.5 to 1.5 mm ² (stranded)
	21/22/24	21 — 24 22	Changeover switch in position II		
	01/02/04	01 — 04 02	Changeover switch in position 0		

AUXILIARY CONTACTS

Fitting of auxiliary contacts:
1309 1001 or 1309 1011.

To fit an AC, the switch must first be put in position 0. An auxiliary contact module comprises: one NO/NC changeover contact for each position (I-O-II). To install use the long screws supplied with the module.

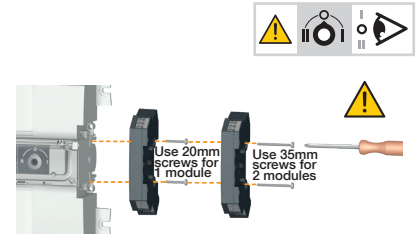

Posidriv PZ2
8.8 lb-in / 1 Nm

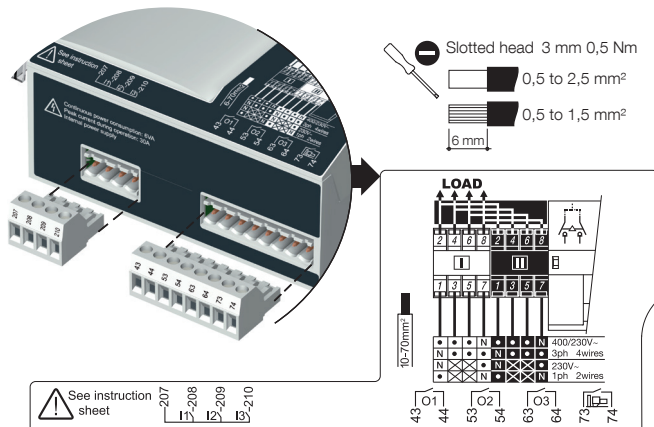

See instruction sheet

Ensure that the product is in Manual Mode (front cover open).

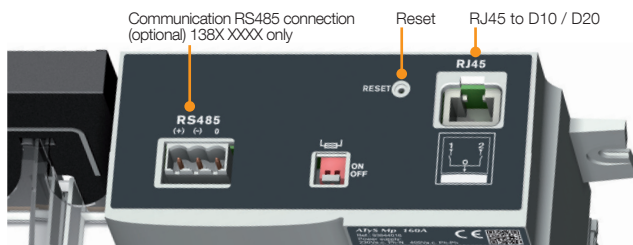
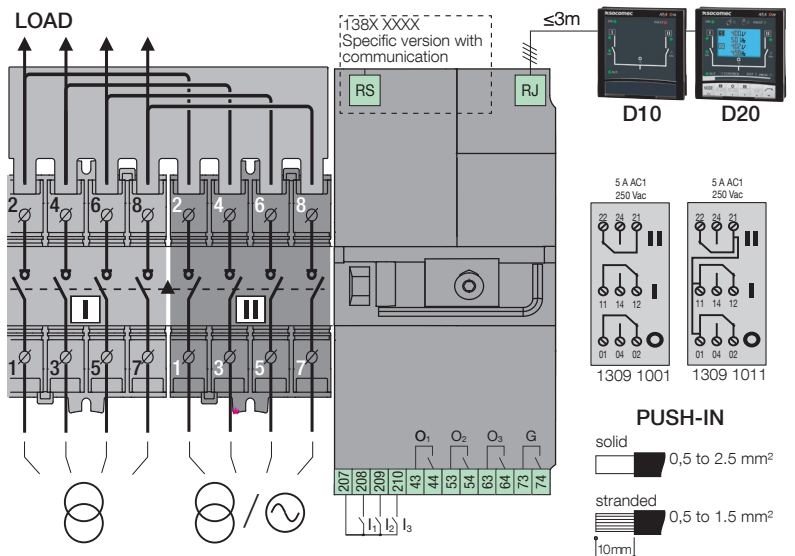

Check

Whilst in manual mode, check the wiring and if ok power up the product.



Programming

Programming access is possible in Automatic mode, when the product is in position I with source 1 available, and in Manual mode in any position and with at least one available source.

Note: for complete programming details download the instruction manual from the Socomec website.

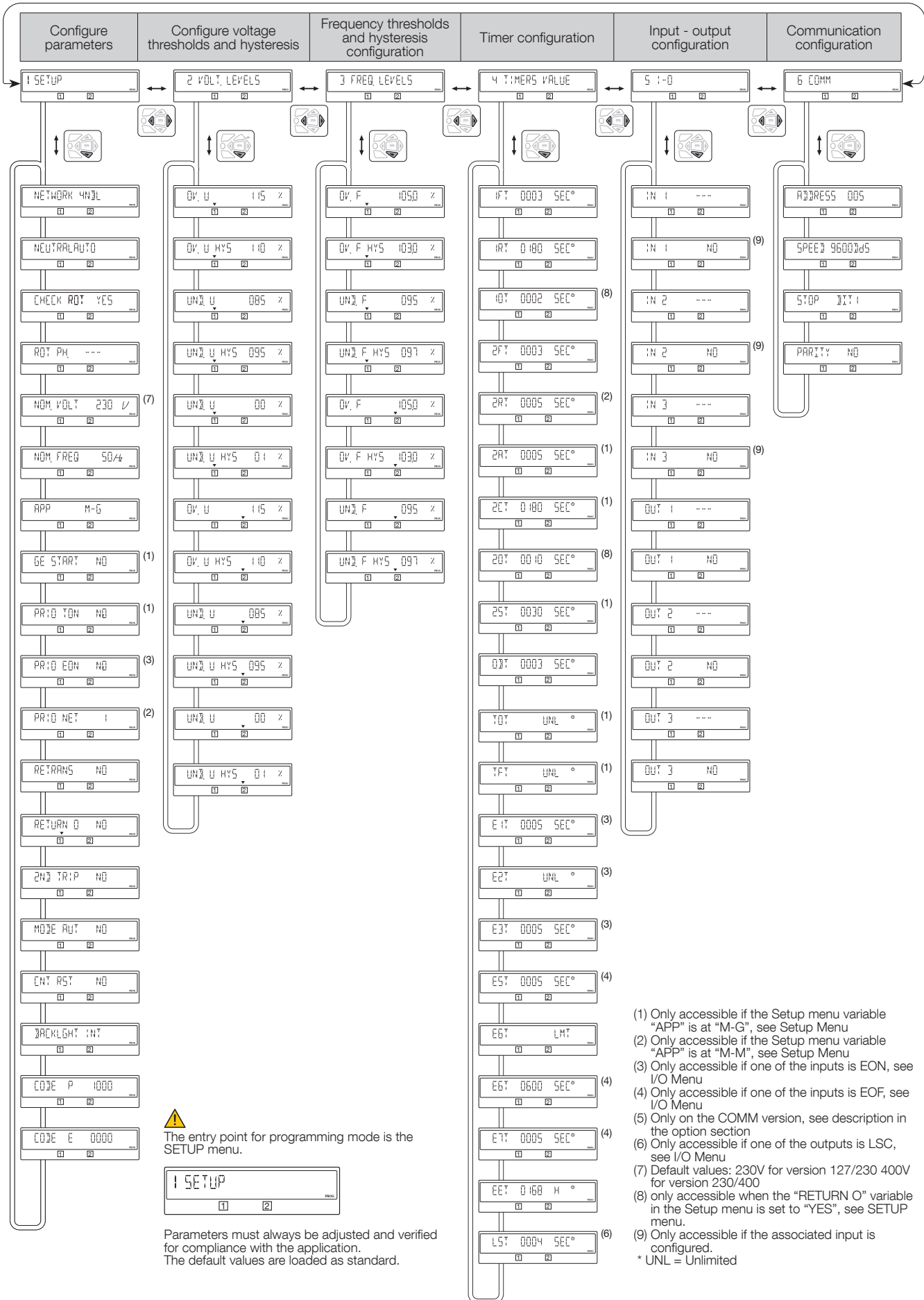

5 Programming

To access programming
Default code: 1000

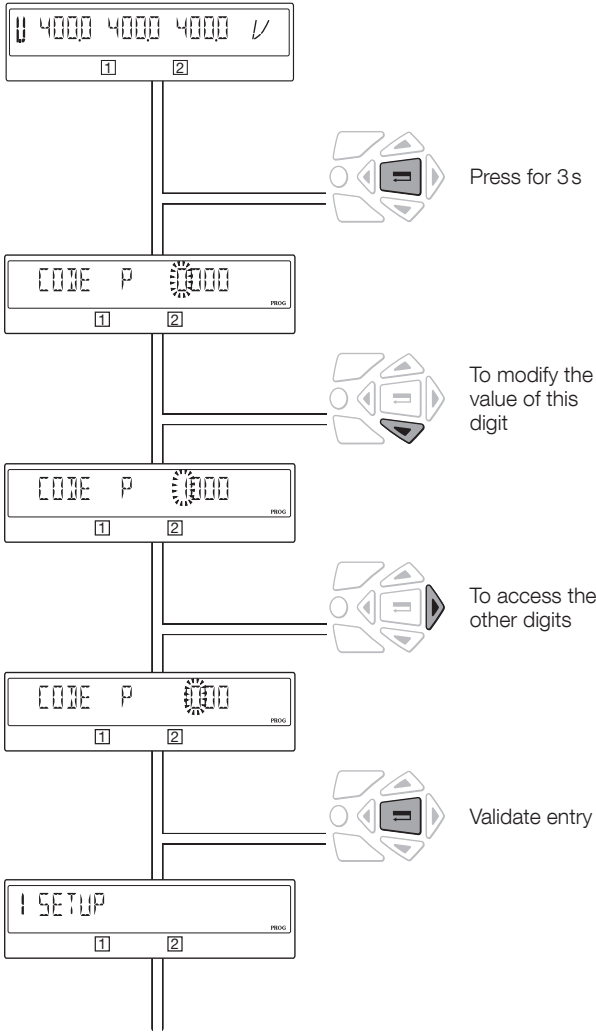

Browsing

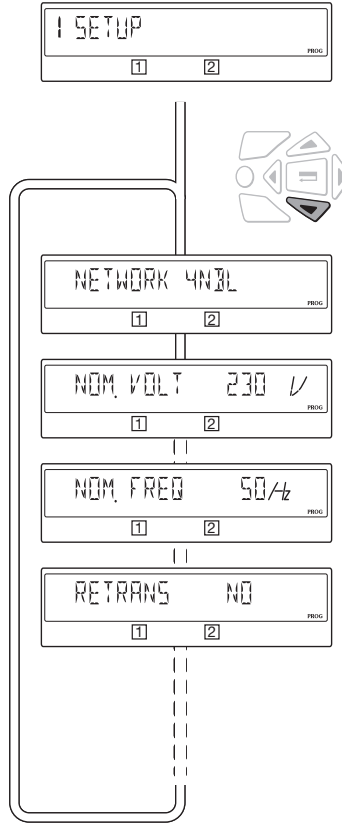

Exit programming



TIMERS		SETTING RANGE	DEFAULT VALUE
1FT	Loss of source 1 Validation timer.	0 to 60 sec(1)	3 sec
1RT	Source 1 return validation timer.	0 to 7200 sec	180 sec
2FT	Loss of source 2 Validation timer.	0 to 60 sec	3 sec
2RT	Source 2 return validation timer.	0 to 3600 sec	5 sec
2AT	Standby network stability validation before transfer.	0 to 7200 sec	5 sec
2CT	Run on timer.	0 to 600 sec	180 sec
ODT	Dead band timer.	0 to 20 sec	3 sec
PARAMETERS		SETTING RANGE	DEFAULT VALUE
NEUTRAL	Neutral position on the switch AUTO: neutral position is automatically detected when the product is supplied the first time. LEFT: neutral must be connected to the left that means on the terminal 1 from each switch. RIGHT: neutral must be connected to the right that means on the terminal 7 from each switch.	AUTO LEFT RIGHT	AUTO
NOM. VOLT.	Nominal voltage Phase/phase or phase/neutral in 1BL and 41NBL	From 180 to 480 Vac	400Vac (230/400V version) 230Vac (127/230V version)
NOM. FREQ.	Nominal Frequency	50 or 60Hz	50Hz
APP	Type of application M-G: network - Genset M-M: network - network	M-G M-M	M-G
RETRANS	Retransfer inhibit feature, press on Validation button required to allow retransfer form Gen to Main	YES or NO	NO
NETWORK	Network configuration*	3NBL / 4NBL / 41NBL / 1BL (230/400V version) 4NBL / 3NBL / 2NBL / 42NBL (127/230V version)	4NBL

(1) 0 to 3600 secs in M-M network

* The wiring must be adapted to the network configuration. Below, the main configuration types.

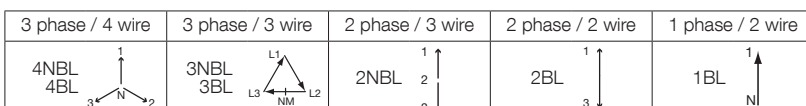

6A Automatic operation

Close the front cover as shown to put the product into automatic mode.



6B Manual operation

- Open the front cover as shown to put into manual mode.
- Use the handle situated in the front panel under the cover to operate the transfer switch.
- Check the changeover switch position on the indicator before operating.

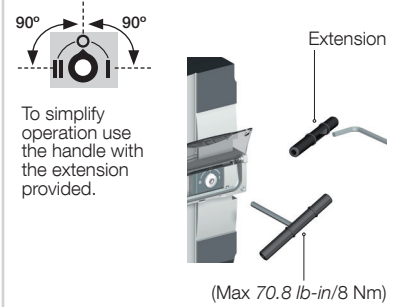

6C Padlocking mode

- In order to padlock put the product in manual mode.
- Pull the locking mechanism and insert a padlock as shown.
- As standard padlocking in the 0 position. Configurable to I-0-II (see step 1).

